

ACORN·USER

WIN A
CUMANA
DISC DRIVE

BBC MICRO · ELECTRON · ATOM

SEPTEMBER 1984 £1

SPRITE DESIGN
MAKE UP
YOUR OWN
CARTOON
CHARACTERS



GAMES:
FRAKI, FORTRESS, CYLON
ATTACK - REVIEWS FOR
ELECTRON AND BBC

EXCLUSIVE:
PARFITT PLOTTER
TRACKED DOWN

EDUCATION:
WRITING PROGRAMS
TO SOLVE PROBLEMS

ELECTRON ACTION:
LISTINGS, REVIEWS
AND ADVICE

DISC UTILITY:
WRITE YOUR
OWN FORMATTER

DOUBLE MEASURE...

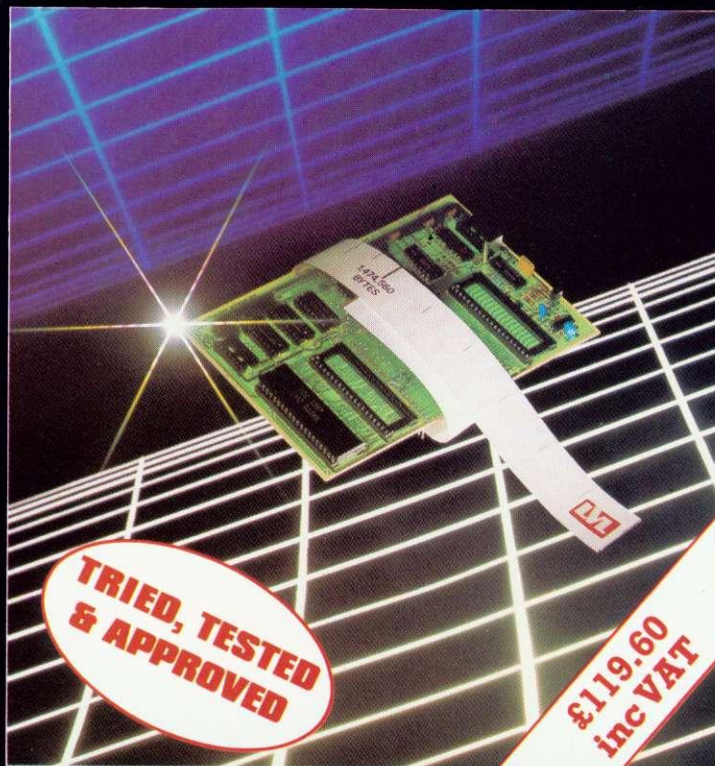

Twice as much storage capacity on your present or proposed discs.

The LVL *true double density* printed circuit board offers an amazing 1,474,560 Bytes of on-line storage, on a twin 80 track double density drive.

Removed is the 8271; (it is not capable of supporting double density). In it's place, a small printed circuit board with a new disc controller and support circuitry provides a much improved data retrieval.

This drastically reduces read errors by using a phased locked loop data separator, which is superior to the standard window circuit.

Your BBC micro will now recognise the media density in the drive, and inform you if it is correct. You may define what density you require, 40 or 80 track, and which sides of the disc to use.

The device gives complete flexibility and comes with an Eprom containing firmware; manual, and a 40/80 track utilities disc. On a dual drive it is simplicity itself to copy existing software from single density to double density.

- Double Density
- Automatically checks for correct density
- No 8271 (Rare & expensive)
- Utilities provided
- Defaults to single density on power up
- 40 or 80 track
- Own PCB with separate 8Mhz clock
- Simple to fit
- User definable density
- Phase lock loop data separator circuit.



Scientific House,
Bridge Street, Sandiacre
Nottingham. NG10 5BA
Telephone (0602) 394000



Computerama

the source

ROM SOFTWARE	INC VAT
Wordwise	39.95
View	59.00
Printmaster	32.95
Caretaker	32.95
Disc Doctor	32.95
Termi (terminal emulator)	32.95
Graphics Extension	32.95
DFS, The Upgrade	27.95
Acorn Speech System Upgrade	55.00
HCCS Forth	39.95
HCCS Logo Forth	67.85
HCCS Pascal	57.00
HCCS Excal	74.75
ROM Expansion Board (ATPL)	

BOOKS	NO VAT
The Best!	43.70
BBC Micro Disc Companion	7.95
Creative Graphics	7.50
Graphs & Charts	7.50
Lisp Manual	7.50
Forth Manual	7.50
BCPL Manual	15.00
Discovering BBC Micro	

Machine Cards	INC VAT
BBC Micro Disk Manual	6.95
Disk Systems For The BBC Micro	1.95

MICRO POWER	INC VAT
Killer Gonilla	7.95
Cybertron Mission	7.95
Cosmic Combat	7.95
Chess B	7.95
Danger LXB	7.95
Escape Moonbase Alpha	7.95
Felix in Factory	7.95
Felix & Fruit Monsters	7.95
Nemesis	7.95
Bumble Bee	7.95
Wizards Challenge	7.95
Jet Power Jack	7.95
Position	7.95
Demon Decorator	6.95
Alien Swirl	7.95
Alien Destroyers	7.95
Space Jailer	7.95
Ghouls	7.95
Moon Raider	7.95
The Mine	7.95
Hell Driver	7.95
Labyrinths of LaCoshe	7.95
Zarm	7.95
Blockbuster	7.95
Rubbie Trouble	7.95
Franny	7.95
Stock Car	7.95

SUPERIOR SOFTWARE	INC VAT
Hunchback	7.95
Overdrive	7.95
Battlefank	7.95
Cosmic Kidnap	7.95
Star Battle	7.95
Moon Mission	7.95
Percy Penguin	7.95
Boris In The Underworld	7.95
Rocky	7.95
Spirit Command	7.95
Crazy Painter	7.95
Road Racer	7.95

OPUS	INC VAT
Dogflight	8.95

BUG-BYTE	INC VAT
Twin Kingdom Valley	9.95

DYNABYTE	INC VAT
Pool	7.95
Horseace	7.95
Lemming Syndrome	7.95
Corporate Climber	7.95

BBC/ACORN SOFTWARE	INC VAT
Algebraic Manipulation	9.95
Business Games	9.95
Castle of Riddles	9.95
Creative Graphics	9.95
Countdown to Doom	9.95
Forth	18.85
Graphs & Charts	9.95
Hopper	9.95
Lisp	16.85
BCPL (Rom + Disc)	99.95
Missile Base	9.95
Meteors	9.95
Kingdom Of Hamil	9.95
Monsters	9.95
Planetoid	9.95
Rocket Raid	9.95
Snooker	9.95
Sphinx Adventure	9.95
Starship Command	9.95
Tree of Knowledge	9.95
Snapper	9.95
Shirley Conran's Magic Garden	9.95
Personal Money Management	9.95
Draughts and Reversi	9.95
Aviator C/D	14.95/17.25
J C B Digger	9.95
Free Fall	9.95
Caroussel	9.95

ACORN SOFTWARE EDUCATIONAL SOFTWARE NOW AVAILABLE	INC VAT
White Knight II	11.50
Vutype	16.10
Tax Calc	17.25
Beyond Basic	11.50
Toolbox	21.00
Canyon	10.00
Record Keeper	15.00
Doctor Who	10.00

ACORN SOFTWARE MIRLE NOW IN STOCK	P.O.A.
IMAGINE	INC VAT
Pedro	5.50
Cosmic Cruiser	5.50

INVASION SOFTWARE	INC VAT
Eagles Wing	7.95
Spooks and Spiders	7.95
3-D Bomb Alley	7.95
Gunsmoke	7.95
Vortex	7.95
Attack on Alpha Centauri	7.95

VISIONS	INC VAT
Snooker	7.95
Digger	7.95
Daredevil Dennis	7.95
Nifty Lift	7.95
Demolater	7.95
Pengi	7.95

PSION	INC VAT
Solocon Sally	6.95
VuCalc	14.95
VuFile	14.95

MELBOURNE HOUSE	INC VAT
The Hobbit	14.95

COMPUTERAMA SOLID STATE JOYSTICK INTERFACE

* with RAPID-FIRE feature

Now a totally new concept in joystick control for your BBC Micro. Simply plug into the analogue port, and connect ANY Micro. Simply plug into the analogue port, and connect ANY Atari type joystick for instant joystick control. FREE keyboard conversion programme allows joystick control of this one - keyboard-only games. No memory - conflicts with this one - due to our unique Relocatable Code feature. ORDER TODAY. Only a few available. Demand is bound to be high. ONLY

£14.95 + 50p Carriage.

RING FOR LATEST PRICES. MANY REDUCTIONS EXPECTED

TORCH Z80 DISC PACK WITH OVER £1.100 OF SOFTWARE FREE

ORDER TODAY - Get the Z80 version of BBC Basic FREE (Www £125) run BBC Micro programmes up to twice as fast, gives 32K for graphics AND 48K for Basic programme.

£199

INC. VAT Free Carriage UK only

Software includes:

- PERFECT WRITER & PERFECT SPELLER & PERFECT CALC & PERFECT FILER & TORCH NET.
- THE TORCH Z80 DISC PACK is the most powerful BBC Micro disc upgrade available; it provides 800K of storage plus a Z80 based Processor running Torch's own CP/M compatible operating system. Clip this ad to your order to receive free 40 80T converter programme.
- NEW TORCH ZEP10 PACK Add Torch Power to any 80 track drives. Complete 2nd Processor AND free Perfect software worth £1000 ONLY.

£343 inc VAT

QUICKSHOT II BBC MICRO JOYSTICK

Now with rapid fire Option and Solid State Interface. Optional Relocatable code feature - means that it WORKS with more games than any other similar interface. This SELF-CENTERING JOYSTICK, works even with sensation at the Micro User Show. More fun - reaches the games other joysticks cannot. Limited supplies of this item.

£9.95 + £1.55 p&p

WE ACCEPT INSTITUTIONAL EDUCATIONAL ORDERS

ATPL SIDEWISE ROM EXPANSION BOARD

- Full sideways Rom
- Expansion to 16 Roms
- 16K Battery backed
- CMOS Ram option
- No soldering required to fit sideways
- Plug-in-and-go construction - Mounts neatly inside the BBC Micro
- Full buffering of address and data buses - prevents data bus loading problems associated with unbuffered boards
- Pin 1 of on-board sockets are connected properly - No spurious crashes due to this known fault on BBC Micro. Existing sockets on BBC Micro are usable. All Eprom sockets are accessible without removing sideways.

ONLY **£43.70** + £1.00 carriage

24 HOUR DESPATCH ON STOCK ITEMS

MAIL ORDER No Stamp Required

Post your order today to

COMPUTERAMA
DEPT. A UB FREEPOST
STAFFORD ST16 2BR

OR TELEPHONE OUR MAIL ORDER HOT LINE With your ACCESS or VISA number, we will endeavour to despatch immediately - (0785) 41899.

Call in today. Home Computer Centre for the BBC Micro enthusiast. Send large SAE for further details of any product

CARRIAGE
Micro's, Monitors, Disc Drives, Cassette Decks £2.00. Leads and software 50p/item (£1.50 max)

50p MONEY SAVER!

with every order, five pounds worth of moneysaving vouchers.

Computerama

STAFFORD
59 Foregate Street
Tel: (0785) 41899

STOKE-ON-TRENT
11 Market Square Arcade,
Hanley Tel: (0782) 268620

SHREWSBURY
13 Castle Gates
Tel: (0743) 60528

EPSON FX80

A SUPERB PRINTER AT A SUPERB PRICE

The most popular of HIGH PERFORMANCE dot matrix printers, has all the features you could ask for:

- 160 cps, 11 - 9 matrix proportional spacing
- Normal, Elite & Italic Characters
- Tractor & Friction Feed 10" Carriage
- Bi-directional Logic Seeking
- Centronics Interface Standard
- Down loadable Character Set, User Defined
- Condensed & Double Width Printing
- Super & Subscripts
- Dot Addressable Graphics.

NOW AT THE AMAZING PRICE OF **£389** inc VAT

QUICKSHOT II BBC MICRO JOYSTICK

Now with rapid fire Option and Solid State Interface. Optional Relocatable code feature - means that it WORKS with more games than any other similar interface. This SELF-CENTERING JOYSTICK, works even with sensation at the Micro User Show. More fun - reaches the games other joysticks cannot. Limited supplies of this item.

£9.95 + £1.55 p&p

QUICKSHOT II BBC MICRO JOYSTICK

Now with rapid fire Option and Solid State Interface. Optional Relocatable code feature - means that it WORKS with more games than any other similar interface. This SELF-CENTERING JOYSTICK, works even with sensation at the Micro User Show. More fun - reaches the games other joysticks cannot. Limited supplies of this item.

£9.95 + £1.55 p&p

ATPL SIDEWISE ROM EXPANSION BOARD

- Full sideways Rom
- Expansion to 16 Roms
- 16K Battery backed
- CMOS Ram option
- No soldering required to fit sideways
- Plug-in-and-go construction - Mounts neatly inside the BBC Micro
- Full buffering of address and data buses - prevents data bus loading problems associated with unbuffered boards
- Pin 1 of on-board sockets are connected properly - No spurious crashes due to this known fault on BBC Micro. Existing sockets on BBC Micro are usable. All Eprom sockets are accessible without removing sideways.

ONLY **£43.70** + £1.00 carriage

24 HOUR DESPATCH ON STOCK ITEMS

HARDWARE CORNER

BBC	INC VAT
ACORN ELECTRON	199.00
BBC Micro Model B	399.00
BBC Micro Model B + Double density DOS	

BBC Micro Disc Upgrade	P.O.A.
BBC Micro A-B Full Upgrade	365.00
BBC Micro Teletext Receiver	225.00
BBC Micro Z80 2nd Processor	T.B.A.
BBC Micro 6502 Upgrade	104.95
Double Density DOS Upgrade	39.95

DISC DRIVES	INC VAT
LVL Dual 100K	340.00
Pace Single 100K	169.95
Pace Single 40/80T D/Sided	282.50
Pace Dual 100K	338.00
Pace Dual 40/80T D/Sided	573.95
Torch Dual 400K Z80 Disc Pack	799.00
Pace 200K 40T D/Sided	243.00

MONITORS	INC VAT
Microvitec 14" Colour	229.00
Sanyo 14" Colour	269.00
Fidelity 14" Colour Monitor	199.00
Grundig 14" Colour TV/Monitor	309.00
Sanyo 12" Green	89.00

PRINTERS	INC VAT
Epson RX80	269.00
Epson RX90FT	299.00
Epson FX80	389.00
Epson FX100	569.00
Shinwa CP80	229.00
Riteman	286.00
Juki 6100 Daisywheel	399.00

MISCELLANEOUS	INC VAT
Sanyo DR101 Data Recorder	39.95
Sanyo DR202 Data Recorder	44.95
Cassette leads - all types	2.80
Computerama Joystick interface	14.95
Quickshot Joystick (FOR BBC MICRO)	19.95
Printer Cable (Parallel) 1.2 m	9.95
BBC Micro Deluxe Cover	5.95
Light Pen	28.75
Data Cassettes 5 x C20/C15	1.95
The Plug Power Filter	14.95

ORDER A COMPLETE SYSTEM - GET ALL LEADS FREE

MICROBYTE	INC VAT
3D Space Ranger	7.95
Pinball	7.95

CLARES	INC VAT
B-Base	25.00
Replica II (Disc Only)	12.00
Graph Disc	12.95
The Key (Disc Only)	12.95
Shadow/Inspector	7.95
State 40/80T for Discs	

DR SOFT	INC VAT
747 Flight Simulator	8.95
Gorph	7.95

AMCOM	INC VAT
Fortress (C/D)	7.95/11.95
Space Highway	7.95

GEMINI	INC VAT
Business Combination Packs	
1, 2, 3, 4	P.O.A.
Data Base	19.95

SOFTWARE FOR ALL	INC VAT
Stock Control (C/D)	19.95/29.95
Invoicing/Statements (C/D)	19.95/29.95
Sales/Purchases (C/D)	19.95/29.95

ADVENTURE INTERNATIONAL	INC VAT
The Hulk	9.95
Adventureland	9.95
Voodoo Castle	9.95
Secret Mission	9.95
Pirate Adventure	9.95

SOFTSPOT	INC VAT
Transistors Revenge	6.95
Heist	6.95

H. SOFT (WATFORD)	INC VAT
Penguin	7.95

ALLIGATA	INC VAT
Spiritfire	7.95
Neanderthal Man	7.95
Blogger	7.95

HEWSON	INC VAT
Heathrow Air Traffic Control	7.95

CRL	INC VAT
Test Match	7.95

A&F	INC VAT
Chuckie Egg	7.90
Cylon Attack	7.90
180! Darts	7.90

AARDVARK	INC VAT
Zalaga	6.90
Frak!	6.90

ADDICTIVE	INC VAT
Football Manager	6.90
MIRROR SOFT	INC VAT
First Steps With The Mr. Men	9.95
MICRO USER	INC VAT
Micro Olympics	6.90
MICRODEAL	INC VAT
Air Traffic Control	9.95
Space Shuttle (C/D)	7.95/9.95
MRM SOFTWARE	INC VAT
Q-Man	5.70
Q-Man's Brother	5.70
Diamond Mine	5.70
Guy In The Hat	5.70
3D Munchy	5.70
Castle Assault	5.70
Darts	5.70

SOFTWARE PROJECTS	INC VAT
Legion	6.95
MOSAIC	INC VAT
My Secret File	9.95
OCEAN	INC VAT
Mr. Wimpy	6.90

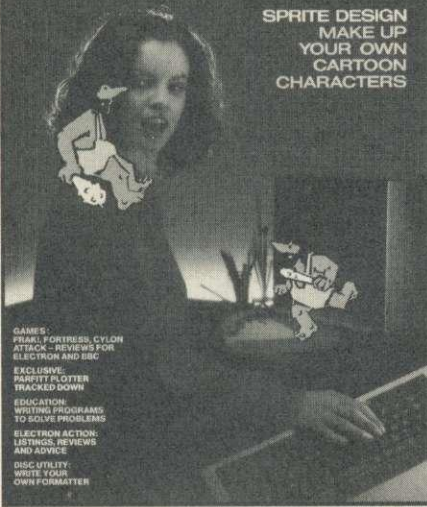

**SPRITE DESIGN
MAKE UP
YOUR OWN
CARTOON
CHARACTERS**

GAMES:
FRANK, FORTRESS, CYLON
ATTACK - REVIEWS FOR
ELECTRON AND BBC
EXCLUSIVE:
PARROT & LOTTER
TRACKED DOWN
EDUCATION:
WRITING PROGRAMS
TO SOLVE PROBLEMS
ELECTRON ACTION:
LISTINGS, REVIEWS
AND ADVICE
DISC UTILITY:
WRITE YOUR
OWN FORMATTER

September 1984 **No 26**
Cover photograph by Chris Ryan; make-up by Marilyn Du Preez; illustrations by Kevin Faerber

Editor Tony Quinn
Production editor Keith Parish
Technical editors Alex van Someren,
Bruce Smith
Editorial assistant Kitty Milne
Art editor Nigel Wingrove
Art assistant Frances King
Publishing director Michael Potter
Editorial director Christopher Ward

Editorial
Redwood Publishing,
68 Long Acre, London
WC2E 9JH. Tel: 01-836 2441

Advertising
Computer Marketplace Ltd, 20
Orange St, London WC2H 7ED.
Tel: 01-930 1612

Subscriptions
Jan Potter, Subscriptions manager.
Tel: Nutfield Ridge (073782) 2957.
Correspondence: Redwood Pub-
lishing, 68 Long Acre, London
WC2E 9JH.

Annual subscription rates:
UK £15
Europe £25
Middle East £30
The Americas and Africa £30
Rest of the World £35
Prices include p&p for 12 issues

Acorn User welcomes submissions from readers. Articles should be typed, double-spaced text, with diagrams on separate sheets. Please enclose programs on disc or cassette, with a listing if possible. Photos should be 35mm, or larger, transparencies, or 5in by 7in black and white prints. Ensure your name is on everything. Please include a suitable stamped, addressed envelope for return. Articles are acknowledged on receipt.

Typeset and printed in Great Britain by Watmoughs Ltd, Bradford. Print production by Aquarius Print and Design, London. Distributed to the news trade by Comag, Tavistock Rd, West Drayton, Middlesex UB7 7QE. Tel: (0895) 44405.

© Redwood Publishing 1984
All rights reserved. No part of this publication may be reproduced without prior written permission of the publisher. The publisher cannot accept any responsibility for claims or errors in articles, programs or advertisements published. The opinions expressed on the pages of this magazine are those of the authors and do not necessarily represent those of the publisher, Acorn Computers Ltd, or Acornsoft Ltd. Acorn, Acornsoft, and the Acorn symbol are the registered trademarks of Acorn Computers Ltd and Acornsoft Ltd.

New Users

First Byte **33**
Two features to show you how those bland-looking listings turn into exciting screen action

Flying start You too can achieve elementary animation effects with Tessie Revivis' 'Fly in the Sky' program, and take the first step in the orchestration of sound as a screen star is born . . .

Para zone The Paranoids drop in and they don't look friendly! As you pick them off you'll also pick up a lot about the techniques of programming procedures. Get tapping and zapping with Michael Why

Hints & Tips **50**
Martin Phillips gives readers a helping hand with advice on keeping control of a scrolling listing; when to use brackets; random numbers from string functions; VDU commands; handling numbers; checks for disc drive and printer; ribbon economy; cassette care; and when to switch off

Letters **59**
Piracy and protection, copying ROM, the big joke in the land of Oz, Break key side effects, computers in adult literacy - all in a lively batch of reader reaction

Dear Kitty . . . **63**
Toughest problem for the newcomer is all the jargon. Kitty cuts a path through the undergrowth. Why those extraordinary symbols? What are sideways ROMs and RAMs?

Business

Nucleus power **113**
John Vaux moves on to the Z80 bundle's Nucleus system generator, which allows a company to create its own menu-based programs. He studies the languages and delivers his verdict on the whole second processor package

Accountability **117**
Also rounded up - Acornsoft's business suite of programs, with a review of the two accounts packages for the small company by Paul Beverley

Education

Problem-solving **65**
Joe Telford again has something for the young User. Six things, in fact: problems. But nothing that can't be solved with a bit of clear thinking . . . and programming

Atom

Smart operators **125**
Barry Pickles clears the computerspeak away from the Atom's indirection operators query (?) and pling (!) and explains the simple logic behind them

Atom Forum **127**
Text processor for Base-2 printers, single-stepping through a machine-code program with VIA fitted, a FILL command, and a wire-frame acorn. Barry Pickles is your MC

Reviews

Torch Unicorn **139**
Andrew Cummins and Peter Voke put Torch's Unicorn system on trial: with its 16-bit and Z80 processors, 20Mb hard disc drive plus floppy drive it opens up the Unix environment to the Beeb

Alternative keyboard **143**
Report on Microwriter's Beeb-specific Quinkey add-on from Peter Voke. Is the keyboard revolution at hand?

Yellow listing pages

You'll find all the main listings of this issue in the yellow pages

- Better RNGs** **i**
- Hi-Basic program, and hardware controller*
- First Byte** **iii**
- Flies and Paranoids*
- Hints & Tips** **v**
- Fifteen routines*
- Kaleidoscope** **vii**
- Whirling chips of colour*
- Spritely characters** **viii**
- Complete designer's toolkit*
- Problem-solving** **xi**
- Six model solutions*
- Disc utilities** **xiv**
- Powerful formatter*
- Atom Forum** **xvi**
- Text processing, single-stepping*

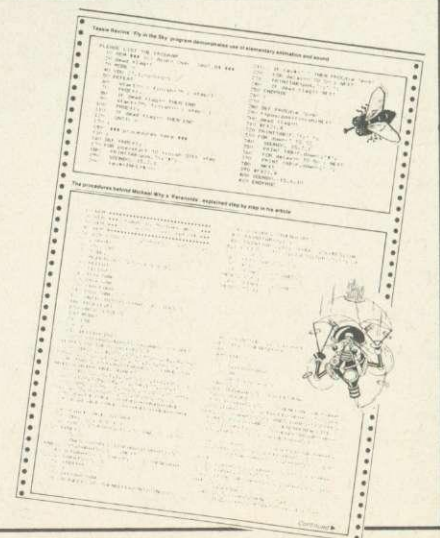

Parfitt plotter 147

Exclusive review of the Parfitt plotter. Chris Steele sees an educational role for this bare-bones, economy machine

Games 153

1984, Incentive's government simulation; *Cylon Attack* and *Chuckie Egg* by A&F; *Overdrive*, *Hunchback* and *Battletank* from Superior; *Dallas* from Cases; *Fortress* from Pace – and hailed as a classic this month: *Frak!* by Aardvark

Utility software 161

Salamander's *Turbo Compiler*, and the three-in-one pack *Multi-Aid*, by Dynabyte

Educational software 163

System software's *Titrations*; text handling with Daco's *The Storyline*; and ABC letter association program *Alphabet* from Opalsoft

Regulars

The News 7

The law that could revolutionise teletext, the thoughts of chairman Curry, new deal for the Electron – plus the latest on the Acorn User Show

Competition 88

Mad Alex dabbles in amicable numbers. Work out the right combination and a Cumana disc drive could be yours. Three drives to be won worth £580

Back Issues 94

Check them out and order yours

Acorn User software 96

Two great games plus all *Acorn User's* listings on a tape

Beeb Forum 97

Bruce Smith presents clever wheezes from readers: Wordwise copies at a keystroke; green screen characters; fastest dump in the West; and teletext editing on-screen

DFS OSWORD II 102

Create your own disc formatter, with a little help from George Hill

How it works 107

Paul Beverley and Nigel Eames in quest of a better random number generator

Top 20 software 137

Spectacular leaps among the best-selling games

User groups 177

Where to make friends

Free ads 178

Readers buy, sell and swap hardware

Small ads 183

Acorn Abuser's Diary 184

Railings, rumours and ridicule

IN THIS ISSUE...

GETTING ANIMATED

I Sprite Design 74

Make up your own cartoon characters and shapes in colour with a few simple keystrokes – and next month we'll show you how to animate them



II Flying program 33

First Byters learn techniques of writing a program to produce movement on the screen and sound

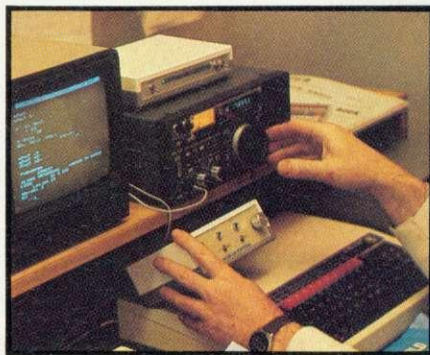

Tapping into Tass 27

With the right equipment you can use your Beeb to unscramble and print-out coded radio teletype signals from around the world. Robin Mudge shows you how

Problem pages 65

'If it takes six men . . .' Joe Telford keeps 'em busy in the school holidays with six classic problems – and how they can be solved by programming



NEXT MONTH...

FREE cover gift!

A re-usable plastic function key strip for your BBC micro or Electron

The origins of life

How a BBC micro is helping to establish a theory of microbes from space

Communications

A round-up of the bulletin boards available for your micro

Cartoon animation

Now you can design sprites, we show you how to move them

Electron music

Software to play tunes on

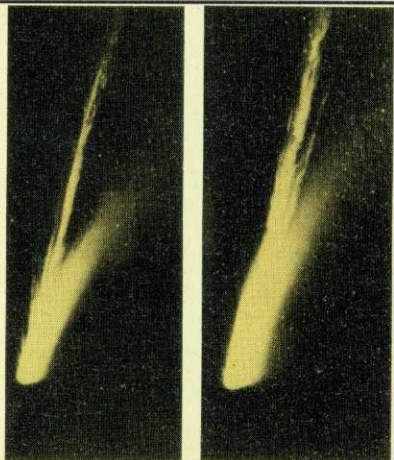

Introducing BEEBUGSOFT

Until recently a very special range of applications and utility packages for the BBC micro has been unavailable to the general public.

This software has been produced by the BBC user group BEEBUG for its members. BEEBUG members tend to be a demanding and discerning group of individuals; and the range of software produced has been kept to a consistently high standard through their constant vigilance.

As a result, BEEBUG software is highly acclaimed amongst BEEBUG's 25,000 members. Independent reviews from the major computing magazines seem to take a similar view of the software, as you can see from their comments.

SPELLCHECK

The disc based spelling checker for text created on Wordwise or View.

"... invaluable ... fast and reliable ... a worthwhile investment"
PCN February 1984
Disc £19.00

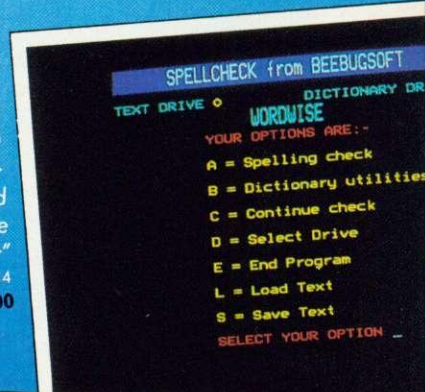

TOOLKIT

27 new commands in eprom to speed up Basic program development and debugging.

"... an indispensable aid"
EDUCATIONAL COMPUTING March 1984
"... worth every penny ... highly recommended"
COMPUTING TODAY June 1984
"... its range of utilities is excellent"
MICRONET May 1984
Eprom £27.00

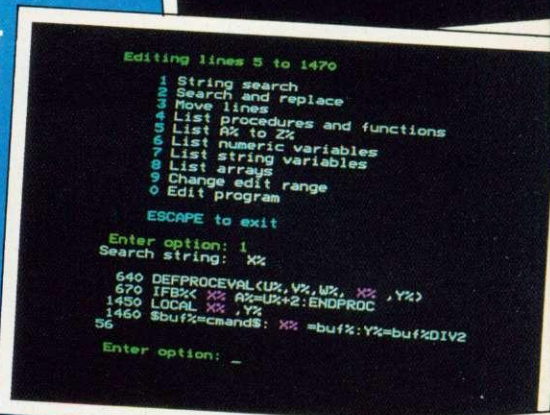

SPRITE UTILITIES

A game writers utility pack enabling high speed arcade games to be quickly written in Basic.

"... definitely recommended ... excellent"
ELECTRONICS AND COMPUTING May 1984
"... Sprite Utilities wins through"
ACORN USER May 1984
Cassette £10.00
Disc £12.00

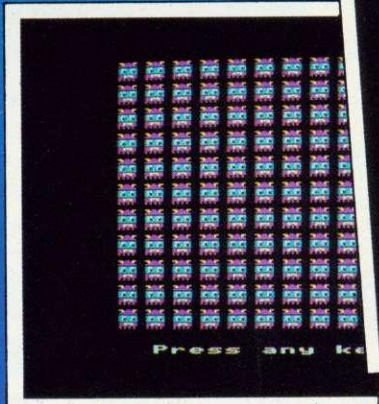

PAINTBOX

Probably the ultimate joystick drawing package on the BBC Micro, great fun and highly educational.

"... amazingly versatile ... easy to use ... (one of the most feature laden picture creating programs around) ... tremendous potential"
EDUCATIONAL COMPUTING Jan 1984
"... a very sophisticated and versatile utility"
ELECTRONICS AND COMPUTING May 1984
Cassette £10.00
Disc £12.00

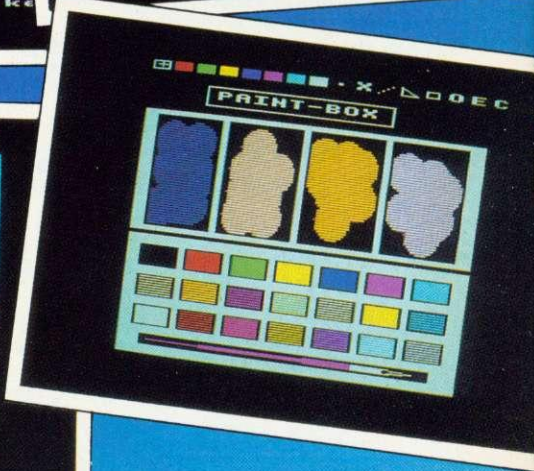
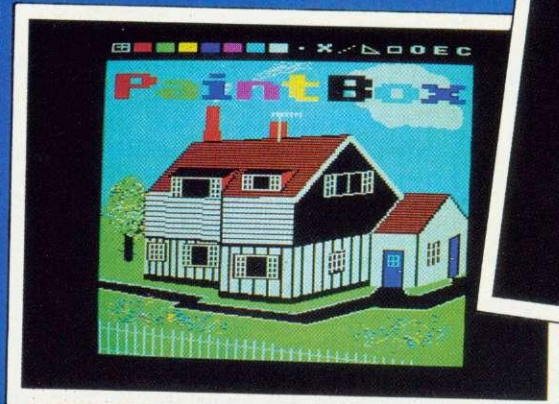

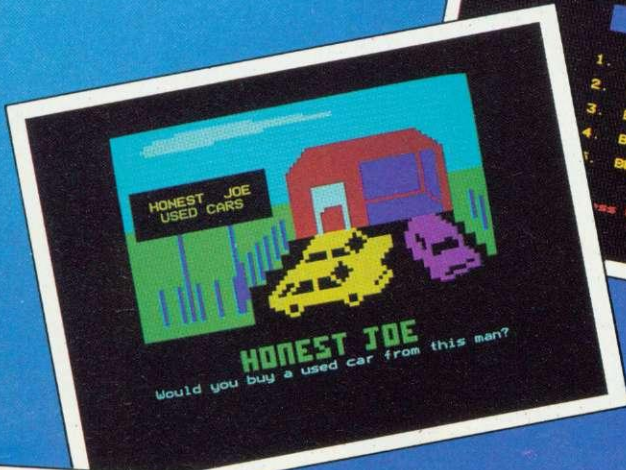

TELETEXT PACK
A powerful screen editor for quickly creating Teletext Mode 7 screens.

"... provides teletext editing facilities in a well thought out manner"
ELECTRONICS AND COMPUTING April 1984

"... a very neat utility"
MICRONET April 1984
Cassette £10.00
Disc £12.00

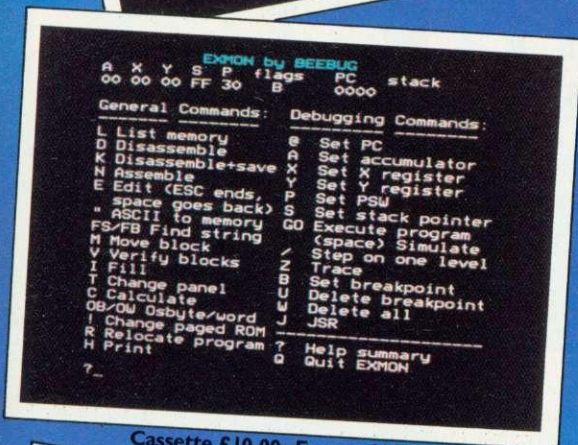

EXMON

An extremely powerful machine code monitor on cassette or eprom, offering 35 new commands for debugging machine-code.

"... exceptionally comprehensive... would be hard to improve upon"
YOUR COMPUTER August 1983
"... using EXMON is a delight"
MICRONET May 1984

Cassette £10.00 Eprom £27.00

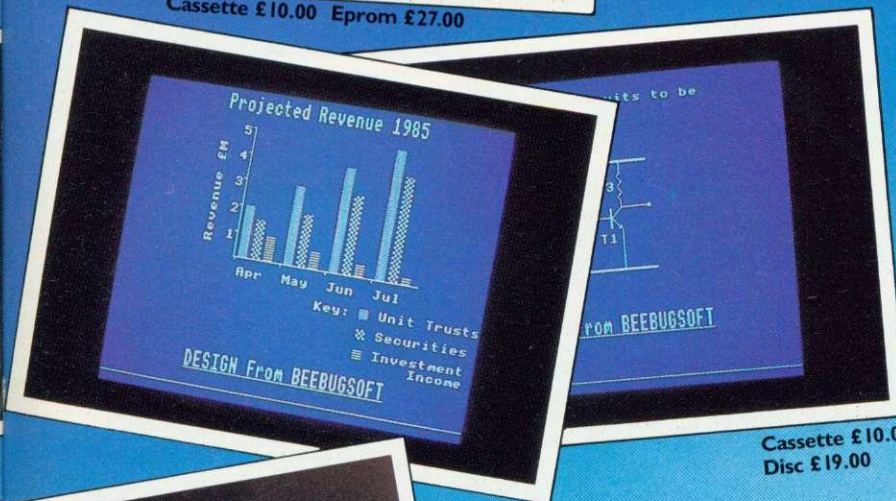

DESIGN

A Computer Aided Design package to allow screens to be quickly created for display, demonstration, handouts etc.

"... a first rate screen processor... immense value to schools and colleges"
EDUCATIONAL COMPUTING April 1984

Cassette £10.00
Disc £19.00

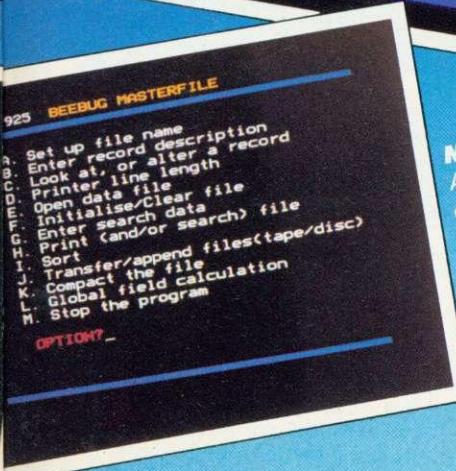

MASTERFILE

A flexible general purpose database on cassette or disc; the disc version using random access files.

"... works well and offers an efficient database"
PCN November 1983

Cassette £10.00
Disc £19.00

If you would like to know more about BEEBUGSOFT products, see the advertisers' index of this magazine, or telephone us for a full software brochure.

BEEBUGSOFT products may now be obtained from major dealers including selected

branches of W.H. Smith. 

Alternatively all products are available from us on mail order from our despatch department in High Wycombe.

BEEBUGSOFT dept 13 PO BOX 109
HIGH WYCOMBE BUCKS HP10 8HQ

TEL: ST. ALBANS (0727) 60263

- The complete AMS disc drive package, tailored to your BBC micro, is compatible with all disc interfaces and includes cables, a comprehensive manual and utilities on either disc or EPROM. Housed in a steel case, matching the BBC micro, these reliable and robust Hitachi 3" disc drives are the ultimate for home, office and classroom.
- The 3" disc is totally enclosed in rigid plastic and a unique automatic steel shutter protects the delicate disc surface from dust and finger marks. For the first time discs can be used in industrial, educational and commercial environments without the worry of corrupting precious programs and data.
- The disc is "flippable" like a cassette tape and has a storage capacity of 100K on each side in single density mode (twice as much when used with a double density interface). A neat plastic switch can be flicked back and forth to write-protect valuable discs.
- The AMS disc drives are completely hardware and software compatible with 5 1/4" drives which can be used in parallel so allowing easy transfer of software. Consequently the 3" drives will operate with all the standard floppy disc interfaces. They take their power from the outlet provided by the BBC micro - there's no onboard power supply to corrupt data.
- The AMS package includes utilities on either disc or EPROM for formatting and verifying discs. The EPROM, which is easily fitted, offers a simple to use and permanent alternative to using the utilities disc.
- The impressively engineered Hitachi 3" drives feature an eject button allowing single handed operation, a multi-colour LED indicating the disc side in use, and a brushless direct-drive motor for reliable operation. The super fast track-to-track access time of 3ms is at the forefront of disc drive technology. The longest of programs are loaded in a flash.

Advance with AMS

3" Disc Drives - The Ultimate Choice

All units include REPLICA II tape to disc software free of charge.

Recommended Retail Price
Single 200K - £169
 (100K per side)
Double 400K - £335
 (200K per disc)
 includes VAT and delivery.

STOP PRESS
 Double Sided Head
 Non-flippable disc
 Single £199
 Double £395
 includes VAT and delivery



Direct Delivery

If not available from one of our 200+ dealers fill in the coupon and we will deliver your order promptly.

Advanced Memory Systems Ltd, Green Lane, Appleton, Warrington WA4 5NG
 RING (0925) 62907 OR 62682

TO: Advanced Memory Systems, Ltd, Woodside Technology Centre, Green Lane, Appleton, Warrington Cheshire WA4 5NG

Please send me

Qty AMS-3 (S) single disc drive all inclusive package at £169 each
 Qty AMS-3 (T) twin disc drives all inclusive package at £335 each.

Prices include utility disc, cables, manual, VAT and delivery.

Please send me by post, if not with drives:
 Qty double sided (100K x 2) discs at £4.95 each.
 Qty packs of five at £22.50 per pack.

Qty Formatting and Verification Utility EPROM £17.25.

I enclose a cheque for £ or debit my credit card

No.  

Name

Address

Post Code Tel No.

Signature Date

 Hitachi - in a word reliability

MAY WINNER

AFTER much deliberation over the 8,000-plus entries for our May competition to count to a million, the winner was John Faris of Oakham, Leicestershire.

He wins a BBC micro wordprocessing system worth £1,100. The winning time was 1.004 seconds to count from one to a million.

See next month's issue for a full report—and the reasons why times of 0.28 seconds were disallowed. Meanwhile, please don't phone us to say you wuz robbed!

Communitel: private view, guest access

by Geoff Nairn

COMMUNITEL is the latest viewdata package for the BBC micro—and also one of the most sophisticated. The basic £45 version lets you create a private viewdata system comprising an editor to create the pages and put them on the database, a program to search and display the pages, and a carousel feature.

Packaged with a BT-approved 'intelligent' modem it sells for £325. In addition to the features outlined, the Beeb can act as a terminal to access Prestel and other viewdata systems. Frames from the remote system can then be put onto the Beeb's local database. The maximum capacity depends on your disc drives: a single 100k drive will hold 95 frames. Telesoftware can also be downloaded.

The most remarkable feature of Communitel—and the one that justifies the £325 price-tag—is the Host system. Using this, the roles are reversed and other people can dial into your private viewdata system.

A telesoftware formatter will convert any text or data file into standard telesoftware format and so make it available to outside callers, no matter what machine they are using.

The Communitel was designed at the Notting Dale Information Technology Consultancy Unit.

New law opens up the potential of teletext

A CHANGE in the law looks set to revolutionise television teletext and establish it as a realistic rival to viewdata services such as Prestel accessed via the telephone.

At present the Independent Broadcasting Authority, which runs Oracle, is allowed to broadcast only uncoded signals, which, of course, cannot be charged for. However, new legislation will give the Authority the right to transmit scrambled information and make subscribers hire decoding equipment.

The prospect was opened up by a last-minute amendment to the Cable and Broadcasting Bill in Parliament. The change was added, with total indifference from most MPs, by Home Office minister Douglas Hurd.

He explained that the IBA had approached the Government with a request for powers to provide new teletext services. 'In particular,' he said, 'it was thinking of providing new information services to specialist occupation or professional groups, such as doc-

tors and farmers, on a subscription basis.'

Receiving Oracle and the BBC's Ceefax is, at present, free (assuming you have a teletext receiver), and downloading free software from Ceefax can be done with a BBC micro and an Acorn teletext adapter.

Britain is estimated to be about five years ahead of the rest of the world in teletext technology and its potential has not been appreciated fully.

Oracle's sales and marketing controller, Humphrey

PROVISION OF ADDITIONAL TELETEXT SERVICES

—(1) If the IBA provide additional teletext services, then, for the purpose of enabling a teletext contractor to make charges for the reception of transmissions containing material provided by him and broadcast in such a service, the IBA may, notwithstanding anything in the 1981 Act, broadcast the transmissions in such a form (whether scrambled, encoded or otherwise) as will prevent any person from receiving them unless he obtains from the contractor the means of doing so.

(2) In this section and in the 1981 Act "additional teletext service" means a teletext service (other than a DBS service) which is additional to those already provided by the IBA under the 1981 Act.—[Mr. Hurd.]

First reading for the teletext clause in the Cable and Broadcasting Bill. It permits scrambled Oracle signals.

Metzzen reckons the possibilities are immense: 'The technology provides opportunities we had not even conceived when we first began transmitting teletext.'

'It was regarded, quite rightly, as a public broadcast service and got lumped with television. But we are now talking about a totally new medium... of which we still don't know the full potential.'

An early application will be aimed at halting the boom in credit card frauds, now totalling about £40m a year.



CARRY ON, CURRY—The BBC has extended its contract with Acorn for another four years. This means that Acorn's Model B can still bear the 'BBC' name. Half a dozen other suppliers had approached the Corporation with alternative machines—among them ACT and Sinclair. Witnessing Acorn chairman Chris Curry's signature on the agreement are Dr Hermann Hauser, Acorn joint MD (left); Bryon Parkin, MD of BBC Enterprises; and (seated) Bill Cotton, BBC Enterprises chairman. When the four years are up, the BBC Model B will be more than six years old. In the meantime, Acorn talks of the micro's expansion possibilities—both existing and planned. On the subject of a 'Model C' it's 'no comment', however.

US database at local call rates

DIALOG Information Services has set up a dial-up computer information service for home micro owners.

Called Knowledge Index, this is a smaller version of its massive Dialog service, used by researchers, scientists and libraries. Dialog provides on-line access to more than 200 specialised databases and contains over 100 million

items of information.

Knowledge Index offers 20 databases, accessing more than 20 million summaries of books, newspaper articles, technical reports and computer programs.

All this information is stored in the US, but you don't have to pay transatlantic phone charges—just a local rate. This is because you use British

Telecom's Packet Switch Stream Service and so dial one of the 18 or so regional PSS numbers.

With the service restricted to outside office hours (6pm to 5am), Knowledge Index is cheaper than the full Dialog service at \$24 an hour.

Further details: Knowledge Index, PO Box 8, Abingdon, Oxford OX13 6EG.

BBC Microcomputer in the NORTH

CTECH Computers Telephone: 061-366-8223/7794

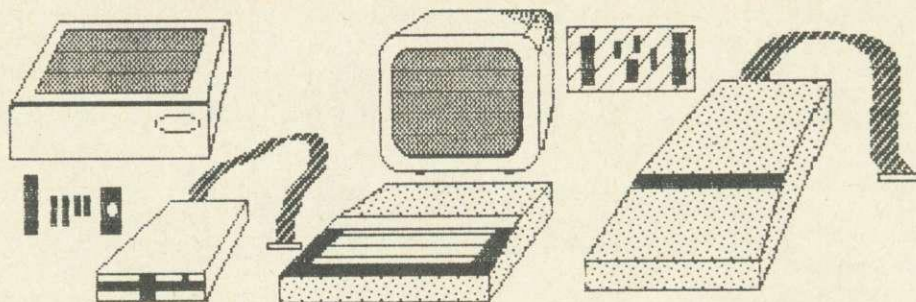

Computers

	£	p
BBC Model B	346.95	
BBC Model B with DFS	407.82	
BBC Model B with DFS & Econet	439.00	
BBC Model B with DFS & Wordwise	433.92	

Acorn Equipment

	£	p
6502 2nd Processor	173.04	
Z80A 2nd Processor	260.00	
Telextext Adaptor	199.00	
Electron Computer	173.04	

All computers come with Free Cassette Lead and Software Package. Most add-ons include free fitting and installation.

Monitors

Philips Hi Res	68.69
Microvitec Normal Res	199.00
Ferguson TX-90 RGB/TV	199.00

Diskettes D.sided, D.density,

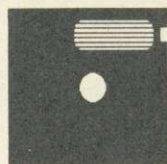

PHONE FOR
CURRENT PRICES.

Addons

ROM/RAM Extension Board	40.43
Light Pen	21.69
OEL 200 Prestel Terminal	87.39
Acorn Speech Synth	47.83
Chip Chat Speech Synth	26.04
Pace Grapevine	POA

Light Pens and Joysticks

Add on Light Pen	21.70
JMB Full Analogue Joystick	13.00
Joystick Pairs	17.35
Hi-Fi Extension Cable	£5.17

ROM Software

Wordwise	34.74
Graphics ROM	28.65
Print Master	28.65
View 2.1	47.83
Ultra-Calc	56.48
1.2 O.S.	7.38
Disk Doctor	25.17
BCPL	86.09
Termi	28.65
Commstar	30.39

Components and Cables

We stock everything e.g.:	
2764 Eproms	6.04
27128 Eproms	POA
8271 Eproms	POA
Printer Cables	12.99
Disk Power Cables	8.65

DISK DRIVES FROM £95.00 + VAT

Bare CHINON F051D, Slimline, 40 Track, Single Sided. 100K (200K Double Density). As above but complete with Cables, Utility Disk, Cables, Case and Manual. **£109.00 + VAT**
 Bare TEAC55F, Slimline, 40/80 Track, Double Sided 400K (800K at Double Density). **£169.00 + VAT**
 As above but complete with Cables, Utility Disk, Cables, Case and Manual. **£199.00 + VAT**

DUAL DRIVES FROM £199 + VAT

Dual CHINON F051D, Slimline, 40 Track, Single Sided 2 x 100K (2 x 200K Double Density). Complete with Cables, Utility Disk, Cables, Case and Manual. **£369 + VAT**
 Dual TEAC 55F, Slimline, 40/80 Track, Double Sided. 2 x 400K (2 x 800K with Double Density). Complete with Cables, Utility Disk, Cables, Case and Manual. (With your drive you may need an interface).

DISK INTERFACES FROM £69.00 + VAT

The Fabulous LVL Single and Double Density Interface. This will allow you to read and write to Acorn Disks see below. But also you can create your own Single OR Double Density Diskettes for extra online storage. Maximum capacity is 1.6 MB with 8 logical drives and 248 files. The standard Acorn Interface is available from us this uses the 8271 disk controller which gives very fast access to disk files. Acorn DFS is the standard for the BBC Micro it allows 31 files per disk and a maximum of 800K on 4 logical drives. **£85.00 + VAT**

PRINTERS

SHINWA CP80. 80 column, friction and tractor feed, Bi Directional logic seeking. Hi-RES and Block Graphics. Sub and Superscripts. Condensed, Emphasised, Underlining, Tabs and Italics plus more! **£199 + VAT**
 CANON PW 1080A. This is the latest state of the art in printer technology. This machine out performs the EPSON FX80. It will do everything the FX80 does and more besides and using the same control codes! What makes the PW1080A so special is not only it's superb value for money but the Near LETTER QUALITY mode. We include a free screen dump and our BBC Micro Instructions as well as the excellent manual. **£259 + VAT**
 QUEN 5100 Daisywheel. This British assembled printer has all the features that you would expect like Auto Bold, Auto Underline, Sheet Feeder option. Take Qume daisywheels and Ribbons. 20Cps Bi Directional. **£299 + VAT**
 All prices Plus VAT

PRICES ...

All our prices are constantly moving, so please ring us to check the latest price.

FREE DELIVERY TODAY (Orders over £90)

ASK ABOUT OUR INSTALLATION SERVICE
 If you are in Greater Manchester, Cheshire, Lancashire, Midlands, Merseyside, West Yorkshire or South Yorkshire, if you ring us now we can send one of our highly trained staff to install your computer equipment today. (Now for business software too!)



CTECH
COMPUTERS

**184 Market Street,
Hyde, Cheshire
SK14 1EX
061-366 7794
061-366 8223**



COMPUTER classes are a 'den of thieves' because of the way teachers rip off educational software, claims Acorn chairman Chris Curry.

In evidence to a House of Lords select committee, he told their Lordships that this was one of the reasons for so little decent educational programs. Software houses, he said, were being put off because of the way programs would be pirated.

Most of the software industry regarded the schools as 'a den of thieves,' and as a result most of the programs are being produced by the teachers themselves.

But he said there was also an 'encouraging' black economy in schools software from pupils.

'There is an enormous industry amongst children at school, producing material from curriculum material that they are learning, which they are then selling on to other people.'

BRITAIN's bid to get in on the 'fifth generation' computers is in trouble, claims Chris Curry.

The British programme, Alvey, was set up with Government blessing and cash based on the hope that it would prod the home-based computer industry towards the fabled fifth generation.

Curry cast doubts on whether Alvey had proved stimulating and attracted people. That might have been true in the beginning, but not any more, he said.

Though admitting that Acorn was involved in the venture he bluntly told the Lords: 'The general belief is that the Alvey programme is faltering badly,

The thoughts of chairman Curry

Chris Curry recently gave evidence to a House of Lords select committee. Here, Bill Penfold reports on some of the topics on which the Acorn chairman spoke his mind.

and that it is in serious need of some re-invigoration.'

The big worry, he explained, was that the funds would be 'gobbled up by the big companies that had traditionally got the Government money'.

A MAJOR question mark is hanging over the future of classroom computers once the present MEP comes to an end later this year and it is worrying Chris Curry. In particular, will teachers still get the necessary training?

He told the select committee of his concern that the progress achieved over the last few years is continued once government funding runs out.

He reckoned the MEP had done a good job on in-service training, but only about 20 per cent of teachers had received a basic awareness level training in modern information technology.

'It would be wrong to think without Government support local authorities will be able to maintain the level of support that the MEP has been providing,' predicted Chris Curry.

What he would like to see was colleges and departments of education being encouraged to ensure all student teachers are familiar with new technology.

DON'T bash Basic because it'll



Chris Curry ... gave evidence

be around for some time yet, according to Chris Curry—a view very different from much of the received wisdom presented to the parliamentary inquiry.

Many of the witnesses said Basic was a barrier and should be dropped as a computer language in schools.

However, the Acorn chief believed that was probably only half right. Acorn, he told the committee, still used Basic as the main programming language and he thought so did most of industry.

'I know there are probably arguments for using high level languages, but Basic has been a very good workhorse so far, and I think it will last us some more years,' he said.

Curry taken to task

CHRIS Curry was taken to task over his evidence on encouraging girls to use computers.

Lady Lockwood complained that the Acorn chief had been apologetic in the way he had explained the need for programs on subjects like knitting. 'The whole problem is that the so-called masculine subjects have always been

taught in a way which does interest boys. I do not think you would have made the same apologetic point had the program been concerned with cricket, or, as so many games are, with warfare.'

Lady Lockwood insisted that computer companies should be looking at subjects girls were interested in.

Gaelic news on a Torch

THE Western Isles of Scotland may be remote but they no longer need be out of touch.

A local viewdata system similar to Prestel called Bruetel has been running since April in the islands' schools and eventually the service will be accessible by anyone.

A Torch computer holds about 3500 pages on a hard disc, which outlying schools can dial-up using a modem and their BBC micro. At the moment, 26 schools have the necessary hardware but soon all of the 70 schools in the

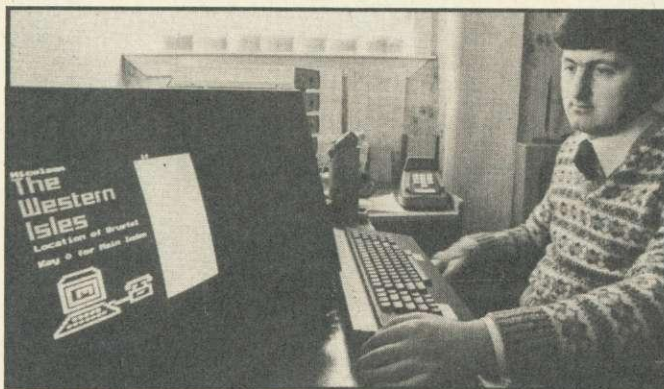

Kenny Matheson in control of the Bruetel system on a Torch

Western Isles Island Council's area should be on-line.

The pages contain local news, 'what's on' information, educational items and re-

sponse frames. Some pages are written in Gaelic. After the service has been tested in schools, it will be extended to local communities.

Micro upgrade kit for Beeb

THE Beeb's 6502 microprocessor has been given an overhaul by one of its manufacturers Rockwell International.

The upgraded processor is christened the R65C02 and uses CMOS technology. In giving the processor a facelift, 31 new instructions have been added.

RCS Microsystems is marketing a 65C02 upgrade kit which also includes patch software to implement the new opcodes mnemonically in the assembler. The kit costs £17.25. Further details on 01-979 2204.

Pace first with drive link for Electron

THE race to produce the first disc interface for the Electron has been won by Pace. The interface, christened 'Le Box', consists of a power supply, PCB with interface and upgraded Amcom Disc Filing System and 5¼in disc drive. Price of the complete interface, including the Pace disc drive, will be £299 plus VAT, and Pace is willing to provide the interface on its own for about £100 less.

Le Box sits underneath the Electron and includes the facility for adding a second drive. Based on the 8271 disc controller chip, the unit is normally supplied with a single-sided 40-track drive providing 100k of storage per disc. Other drives may be supplied on request, including a 40/80 switchable unit offering 400k.

Le Box also includes eight sideways ROM sockets to allow Electron-compatible ROM firmware to be used. First units for retail sale will be at the Acorn User Show.

Hunting the hare

HARESOFT has launched a computer version of the famous *Masquerade* treasure hunt. Readers of Kit Williams' book had to locate a buried golden hare, and Haresoft has bought it off the winner and is offering it as a prize in the software puzzle—or the winner can have £30,000 in cash.

No digging this time—you just tell Haresoft where the hare is hidden. The program is produced in two parts costing £8.95 each; the first tape is already out and the second will be released next month. Haresoft is at PO Box 365 London NW1 7JD.



The BBC MIDI interface from Rose-Morris will work with any MIDI standard synthesiser. Hear it at the Acorn User Show

Electron gives C4 a hearing

NOTWITHSTANDING the renewal of its contract with the BBC, Acorn is including cassette versions of programs featured on Channel 4 in its Electron starter pack.

Along with the micro, buyers will get a cassette recorder, *User Guide*, beginner's programming manual, introductory cassette—plus a book and software tape based on Yorkshire Television's *Me and My Micro* series. The starter pack costs £245.

The five programmes, first shown on Sunday mornings in June, are to be repeated on Monday evenings at 5.30 on Channel 4, starting September 17. They aim to teach Basic programming to the complete novice—unlike the BBC's computer programmes which cover mainly applications. The computer programs featured in *Me and My Micro* can be used with any machine. The

listings are available on cassette for the Spectrum and Electron, and it is these tapes that are included in the Electron starter pack.

Acorn has also extended its range of Electron software from 12 titles to 30, all of them being conversions of Beeb software. They include *Desk Diary*, *Creative Graphics*, *Personal Money Management*, *Draughts* and *Snapper*.

●Plus-1, the Electron's ROM box, has come in for criticism because two of the programs on the introductory cassette will not load when it is connected to the computer.

The problem is caused when the Electron tries to read data files. The Plus-1 can be 'turned off' with a series of *FX calls and normal operation restored, but nevertheless the fault is an embarrassment in a product aimed at the inexperienced user.

Beeb learns more languages

TWO new languages join the Acornsoft range: S-Pascal and Turtle Graphics.

S-Pascal is a subset of the full language, aimed at the education market. One major limitation is that it only supports integer number variables. Turtle Graphics is a subset of the Logo language, using just the graphics com-

mands to move a 'turtle' around the screen. Both languages cost £16.85 on tape or £19.90 on disc.

Full implementations of both Logo and Pascal are planned for the autumn. Pascal will come on two 16k ROMs and will conform to the ISO specification. Acornsoft's Logo, also on two ROM chips, will be able

to control floor turtles.

Three other versions of Logo for the BBC micro are due to arrive next month. From the Open University, LSL and LCSi. LSL's version will come on a 16k ROM chip, the others on a 32k chip.

Acornsoft also promises for the autumn a BBC micro version of Comal on 16k ROM.

Beeb-bopping on six tracks

ROSE-MORRIS, which sells musical instruments, is marketing a synthesiser interface unit for the BBC micro. Using a compatible keyboard synthesiser, up to six tracks of music can be composed and then stored in the Beeb's memory. On playback, notes can be altered in pitch and length using the red function keys and the music can be displayed in notation form on the screen.

The interface costs £159 and will work with any MIDI synthesiser (MIDI—Musical Instrument Digital Interface—is the connection standard for computers and synthesisers). The cheapest MIDI synthesiser costs about £500.

The BBC B MIDI, as the interface is called, consists of a small box which plugs into the Beeb's user port and 1MHz bus, while the other end connects to your synthesiser. This is the first home computer MIDI interface and it will be at the Acorn User Show.

Video mixing

A RANGE of products from Video Electronics enables the BBC micro to interface with other video equipment.

Beeb-Lock is a small box which synchronises the RGB video output of the micro to an external signal—from a video recorder or camera, for example. Once synchronised, the two signals can then be mixed. A typical application would be to superimpose captions or graphics onto a video picture; the captions are typed on the Beeb and the picture comes from a video recorder.

The basic Beeb-Lock, costing £220, takes its power from the BBC micro auxiliary power socket. An enhanced version, at £380, comes with its own power supply and a 'Downstream Mix/Key' feature, which lets you add computer text to the video signal without having a separate video mixer.

Planned for the autumn is a colour mapping board that should interest Acorn Bitstik users. Instead of being restricted to the Beeb's eight colours, you can make up your own from a palette. The Bitstik exploits this feature by letting you 'mix' the colours on the screen. Video Electronics is at Wigan Road, Atherton, Manchester.

Strike Control

TWO PRECISION JOYSTICKS

- Set of 2 precision joystick controllers.
- Full analogue control with 2 potentiometers.
- Self centering.
- 2 responsive fire buttons positioned for maximum ease and comfort.

Compatible with
*Acorn *BBC Model B
Computers.

- Short, slimline joystick with thumbcup for sensitive fingertip control.
- Easy and comfortable to hold.
- Rubber feet for table-top use.

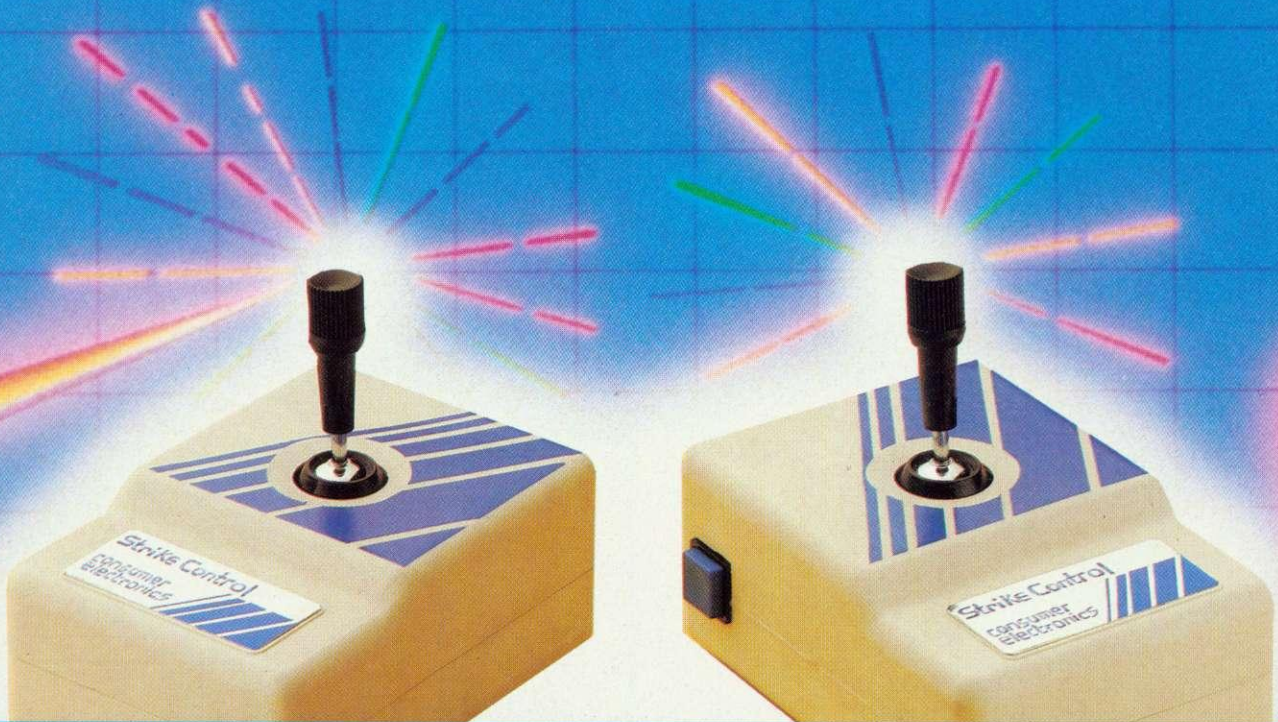

Strike Control is available from most Spectrum and good computer shops.

consumer electronics limited

Failsworth, Manchester M35 0HS
Telephone: 061-682 2339

*Trade marks and/or trade names of companies concerned.



The Graduate.

**The first IBM PC
compatible upgrade
for the BBC model B micro.**

From only £764.00 the new Torch Graduate will upgrade your BBC Model B to a powerful 16 bit business computer

TECHNICAL SPECIFICATION



- 8088 16-bit processor running at 5 Mhz
 - 128K or 256K RAM
 - MS™-DOS operating system customised to IBM compatibility
 - Model G400 – Single, double sided, high density disc drive (320K formatted)
 - Model G800 – Twin, double sided, high density disc drives (640K formatted)
 - Integral stabilised power supply
 - 2 IBM PC compatible hardware expansion buses
 - Software compatibility allows Lotus 1-2-3 and all popular IBM PC business programs to run without modification, subject to the constraints of the BBC keyboard and display
 - Disc interface is not required
- Keyboard text and graphics supplied by BBC Model B

• THE GRADUATE •

Disc and hardware compatible with the IBM PC, the Graduate is the latest addition to the Torch range of BBC upgrades. It's MS™-DOS operating system is customised to IBM compatibility allowing exploration of the massive range of IBM compatible business software, programming aids, compilers and languages universally available from most major software houses.

Introduction to MS™-DOS

The Graduate offers two levels of upgrade, the G400 and the G800, both with 128K on board user memory as standard (optionally 256K). This can be increased to 1.2 Mbytes with an IBM compatible expansion board. The G400, contains a single, double sided 320K formatted disc drive and provides the low cost introduction to MS™-DOS for the

user who wants real 16 bit power from his Model B.

More data storage

A step up from the G400 is the G800 which offers twin, double sided 320K disc drives for extra data storage. Both the G400 and the G800 provide the possibility of further expansion for networking, modems, etc., via the IBM compatible hardware slots provided

by the Graduate models. Each model comes complete with a well written user/technical manual and connecting leads.

Just plug it in

Unlike other add-ons there is no need to open the BBC to make the connection. The compact and tidy Graduate models simply plug in to the 1MHz bus on the Model B. Within minutes you can be up and running with an IBM PC compatible system that really means business.

The range

Add 256K RAM, 640K disc storage and IBM PC compatibility to the BBC Micro for less than £1,000.

Graduate G400 (128K) £764 inc. VAT
 Graduate G400 (256K) £815 inc. VAT
 Graduate G800 (128K) £949 inc. VAT
 Graduate G800 (256K) £999 inc. VAT

For further information complete the coupon today.



TORCH COMPUTERS



Lighting the way ahead.

Torch Computers Limited
 Abberley House, Great Shelford, Cambridge CB2 5LQ.
 Telephone (0223) 841000. Telex 818841 TORCH G.

The Graduate is manufactured by Torch Computers under licence from Data Technologies Ltd.

To: Torch Computers Ltd., Abberley House, Great Shelford
 Cambridge CB2 5LQ. Telephone (0223) 841000
 Please send further information on the Graduate and the
 address of my nearest dealer.

Name _____

Address _____

Post Code _____

Telephone _____

20,000K Winchester Disc for your BBC Micro

INTEC MAKES THE BBC REALLY COMPETE WITH
SYSTEMS COSTING 2X AS MUCH!



- ▶ Supports BBC and Acorn DFS.
- ▶ Full file handling and diagnostic software utilities.
- ▶ Data capacity from 5 Mb upwards.
- ▶ High speed accessing.
- ▶ UK manufactured.

The INTEC 505 gives all these benefits PLUS the removable hard disc cartridge providing a compact, secure and usable back-up or cartridge per application approach. Why pay more for less?

For full details on the INTEC range of hard discs for the BBC Micro, complete and post the tear-off slip or **phone INTEC now - 01-761 5999.**

INTEC
41A-45 Knights Hill
West Norwood, London SE27 0HS
Telex 8813271 GECOMS G

SEE US AT
The 2nd
Official
Acorn User
Exhibition
OLYMPIA
16-19 AUGUST
1984

INTERFACE TECHNOLOGY
INTEC

Please Cut Out and Return

The INTEC Hard Disc Range

5-20 Mb Winchester and the fixed and removable 505.

NAME _____

ADDRESS _____

BBC



The 2nd Official Acorn User Exhibition

Held for the first time at London's Olympia 2, the Acorn User Show this year runs from Thursday August 16 to Sunday the 19th. Hours are: Thursday 10-7 (morning, trade-only), Friday and Saturday 10-6, and Sunday 10-5.

15

Beeb shows confidence as a business tool

FOR the business user, big or small, the BBC micro now offers some powerful systems and this will be reflected at the show. The Torch subsidiary of Acorn now has a range of upgrades for the BBC micro from the Z80 second processor at £340 (with the Perfect series of software), to the Unicorn, which at £3300 gives access to the powerful Unix operating system and a 20Mb hard disc. See page 139 for review.

Torch has also taken over the Graduate upgrade from DTL and is selling the cheapest version at £765. The Graduate has a 16-bit processor, 128k of RAM and a 400k disc drive. More important, it is compatible with the large range of software available for the IBM PC, even to the extent that IBM discs will work on the Graduate.

Acorn's own Z80 second processor, sold with a mixed bundle of business software, will also be highly visible. No doubt the Acorn right hand will pretend the Torch left hand doesn't exist. Another intriguing point: will Acorn be mouthing the initials ABM?

Intec will be promoting its 505 Winchester disc drives with an 'adults-only' ice lolly competition. It's not quite as risqué as it sounds. You get a Walls Megabyte ice lolly and are then entered in a lottery; if your name comes out of the hat you win one of Intec's 505 Winchester disc drives, worth more than £3000. The 505 will connect up to your Beeb and has removable hard discs - so offering virtually unlimited

More show news and information on page 18

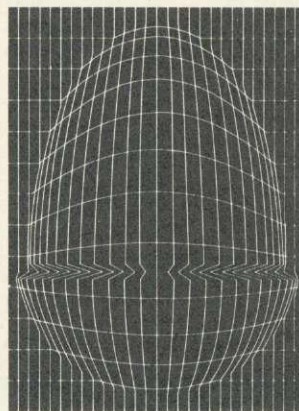

storage. Why 'adults-only'? Well, Intec is determined to prevent its stand being besieged by children thirsting for a free ice-lolly.

If you are looking for a printer yet are worried about how to get it to work correctly, then CJE Micro's stand is one to visit. The company is offering a range of printer packs using Star, Juki and Canon printers. In the pack you get the printer, a cable for the BBC micro, View printer driver, a screen dump program, operating booklet, 100 sheets of paper and even a mains plug! Typically such a package adds about £20 to the price, but CJE is promising cheaper prices for the show.

Quinkeys in quadruplicate

THE Quinkey is an 'alternative keyboard' for the Beeb developed from the well-known one-handed Microwriter. Its maker, Microwriter Ltd, supplies an interface that allows four Quinkeys to be connected to the Beeb simultaneously in a special education pack with software. For a full review and prices turn to page 145 of this issue, or see the Quinkey in action at the show.

Data Efficiency will be showing two pieces of hardware of particular interest to schools: the Strobe graphics plotter, which comes with BBC micro software and costs £229, and the Taxan NLQ dot-matrix printer, which for just £344 offers near letter-quality print (reviewed in the June issue).

Keyzone's 'Printer sharer' is a switch unit that enables up to six computers to share a single parallel printer. A serial version is also available. The 'Printerchanger' works the other way round - one computer can switch between three different printers. Few schools will have the luxury of three different printers, but many businesses use both dot-matrix and daisywheel printers from a single micro.

Thomas Nelson, one of the largest educational publishers, will be showing its Nelcal range of software. New titles include *Statpack*, a data-logging package for science subjects; *Biology* for A-level students; and *Micromapping*, a suite of six programs that develop map skills in junior children.

Win a monitor or a printer

THERE'S a prize to be won every day at the Acorn User Show. In an easy-to-enter competition *Acorn User's* publisher, Redwood, is giving away two Microvitec colour monitors and two Acorn spark-jet printers.

All you have to do is answer

the six questions posed on page 5 of the show guide, complete the rest of the entry form and hand it in during the exhibition to Redwood Publishing at stand 98.

The first correct entry picked out of a hat each day will win a monitor (Thursday

and Saturday) or a printer (Friday and Sunday). Runners-up will receive *Acorn User* games packages.

Winners will be chosen at 6.30pm each day and prizes forwarded after the show finally closes on Sunday, August 19.

SINGLE BOARD 6809 2nd PROCESSOR FOR THE BBC MICRO.

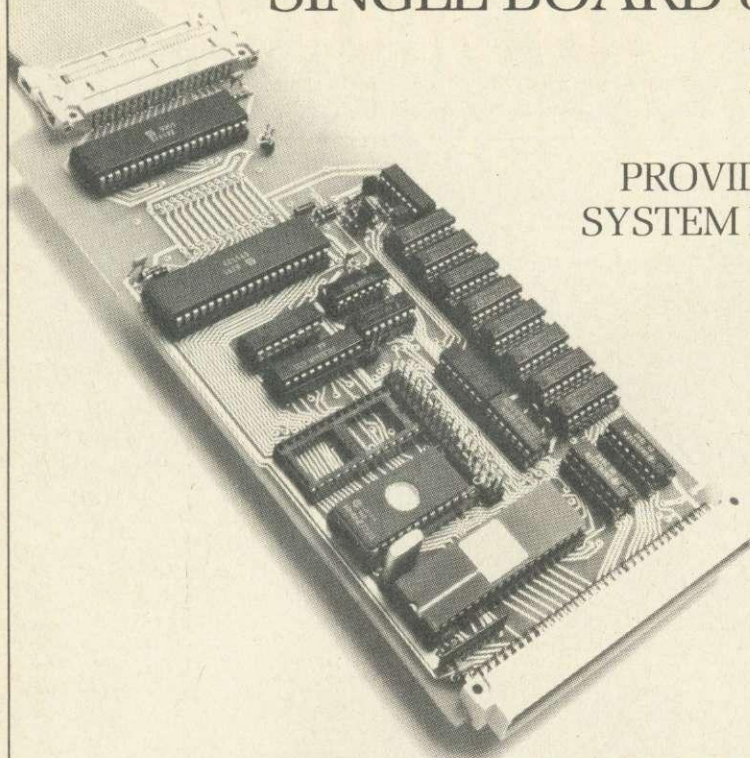

PROVIDES A LOW-COST DEVELOPMENT
SYSTEM FOR INDUSTRIAL APPLICATIONS.

- Sits inside the BBC or plugs into an extension rack
- Enables standard FLEX format discs to run on BBC.
- Supports High Level Language Compilers
- Cross Assemblers and Disassemblers for most micros
- Connects directly on to the tube
- 64k DRAM on board
- Two 28 pin byte wide memory sockets
- Acorn Bus compatible DIN 41612 Bus interface
- Also available as a single board controller

One of an exciting new range
of Eurocards from:

GMS

44a Hobson Street
Cambridge CB1 1NL
Tel. 0223 324141

Cambridge
Microprocessor
Systems Limited



**MICROMAN
Computers**

ACORN SPECIALIST COMPUTER CENTRE

Z80 SECOND PROCESSOR

With the addition of the Z80 second processor the BBC becomes a business machine fully compatible with CP/M software. The Z80 comes complete with word processing, database, spreadsheet, graph plan and accounts programs as well as CIS COBOL, Nucleus System Generator, Z80 Professional Basic and GSX Graphics.

PRICE £299.00

TELETEXT RECEIVER

Converts your BBC into a Teletext Terminal giving normal reception of Teletext pages and enabling you to download a large range of free software.

PRICE £225.00

ACORN PRICES

Acorn Electron	199.00
Electron Plus 1 Interface	59.90
BBC Model B	399.00
BBC Model B + DFS	469.00
BBC Model B + Econet	446.00
BBC Model B + DFS + Econet	516.00
Acorn Teletext Receiver	225.00
Acorn Prestel	P.O.A.
Acorn 6502 2nd Processor	199.00
Acorn Z80 2nd Processor	299.00
Acorn IEEE Interface	325.00
Bitstick	375.00
Econet System	P.O.A.
A-B Upgrades	95.00
DFS Upgrade	95.00
Econet Upgrade	70.00
Speech Synthesizer	55.00
View ROM	59.80
Viewsheet ROM	59.80
BCPL ROM	99.65

6502 SECOND PROCESSOR

The 6502 second processor will allow the BBC to run faster with greatly increased memory especially in high resolution graphics modes giving users more power when writing their own programs and access to a range of exciting new programs such as the programs that drive the Bitstick.

PRICE £199.00

BITSTICK

This superb menu driven graphics package allows high quality CAD at a very modest price allowing the user to create shapes on the screen and produce outstanding graphics, architects drawings etc.

PRICE £375.00

IEEE INTERFACE

A full implementation of the IEEE standard, providing computer control compatible scientific and technical equipment.

PRICE £325.00

ACORN APPROVED SERVICE CENTRE

Our workshop offers a comprehensive service including Repairs and Upgrades by our own engineers

EDUCATIONAL & INDUSTRIAL ENQUIRIES WELCOME

All prices include VAT, Post & Packing £9 (Large items) £1 (Small items ROM's etc)

RAINFORD INDUSTRIAL ESTATE, MILL LANE, RAINFORD,
ST HELENS, MERSEYSIDE

PHONE 074488 5242

TO MICROMAN COMPUTERS, RAINFORD INDUSTRIAL
ESTATE, MILL LANE, RAINFORD, ST HELENS,
MERSEYSIDE WA11 8LS.
Please send me a copy of your
full price list and newsletter.

NAME _____
ADDRESS _____



Bad mode? no room?

ONLY
AVAILABLE
on the
Twillstar
COMPUTER STAND
No 125 at the
1984 ACORN
USER SHOW

Solve your problems in 5 minutes with the...

RAVEN-20

Features include...

- PROVIDES 20K OF USABLE RAM
- ALLOWS THE RUNNING OF PROGRAMS UP TO 28K LONG IN ANY SCREEN MODE
- RAVEN 20 IS COMPATIBLE WITH ALL CORRECTLY WRITTEN SOFTWARE
- SIMPLE PLUG IN AND GO DESIGN
- SPECIAL COMMANDS FOR SOFTWARE WRITERS
- COMPLETELY TRANSPARENT TO BBC OPERATING SYSTEM
- NO SOLDERING OR CUTTING OF TRACKS
- USES ONLY DOCUMENTED MOS CALLS
- LOW POWER DYNAMIC RAM DESIGN + MANUAL
- SELF TEST FACILITY
- COMPLETE WITH ROM BASED SOFTWARE
- CAN BE FITTED TO BBC MODEL B FITTED WITH OS 1.2

THE ULTIMATE IN DESIGN & PRICE

ONLY
£69.95
INC VAT

RAVEN MICRO PRODUCTS

1 SAVILLE ROAD · WESTWOOD · PETERBOROUGH PE3 7PR · TEL 0733 260930

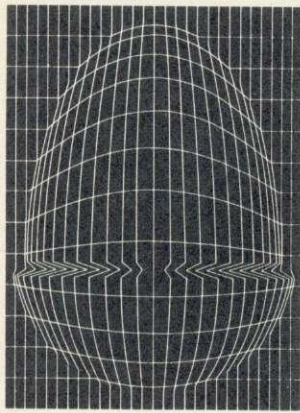

More elbow to Beeb's power

GRAPHICS tablets seem to be this year's favourite peripheral, especially with schools, and at least three rival versions will be on display at the show.

The CTS Professional tablet—the most expensive—uses a magnetic tablet and pen to give a resolution of 0.25mm and a high degree of linearity and accuracy. To exploit the tablet to its full, a software package called *CADPAK-D* lets you scale, zoom and rotate drawings, and reproduce common shapes. The tablet costs about £630, plus £55 for the CAD software.

Much less expensive at just £50 is the graphics tablet from Reekie Technology. The Image Plotter both resembles and works like the traditional drawing pantograph arm used for tracing drawings and photographs. Scientific Systems has a similar product, the Tarren Digigraph Plotter, which it sells for £91.

Confusingly, the word plotter is used to describe both input and output devices. Parfitt Electronics' DP025 Plotter, reviewed on page 147, falls into the latter category. Using commands similar to BBC Basic's DRAW and MOVE, and cheap fibre-tip pens, it can plot complex shapes and diagrams on paper. Alternatively the pen can be replaced by an opto-sensor, and drawings can be scanned and displayed on the screen. The basic plotter costs £270.

The Droid Factory's £400 robot arm was covered in last month's preview and Commotion will be showing its Beastly Arm. It has all the features of its big brothers for £30.

Elk gaps plugged

As an economy version of the BBC micro, the Electron has several shortcomings. The lack of a joystick port, for example, is a serious omission in a home computer, and several companies have been quick to plug the gap.

Sir Computers has produced a PrintStick interface which, as well as letting you use joysticks with the Electron, also gives it a Centronics

printer socket. You can take one away at this year's Acorn User Show for just £39.95—a saving of £5 over the normal price. First Byte Computers will be selling a 'no-frills' joystick interface for £24.95.

Both joystick ports are for digital switch-type joysticks such as the Atari, rather than the analogue potentiometer version which Acorn markets. If you want to use joysticks

with a program, you should first find out which kind it uses.

Electron owners also complain at the lack of mode 7 graphics on their machine. Sir Computers has come up with the first mode 7 adaptor, a demonstration version of which will be unveiled at the show. You won't be able to buy one there, but when they go on sale they should cost well under 100.

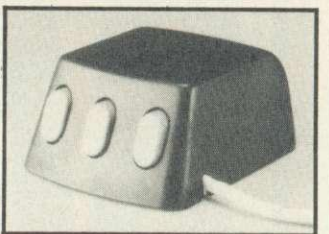
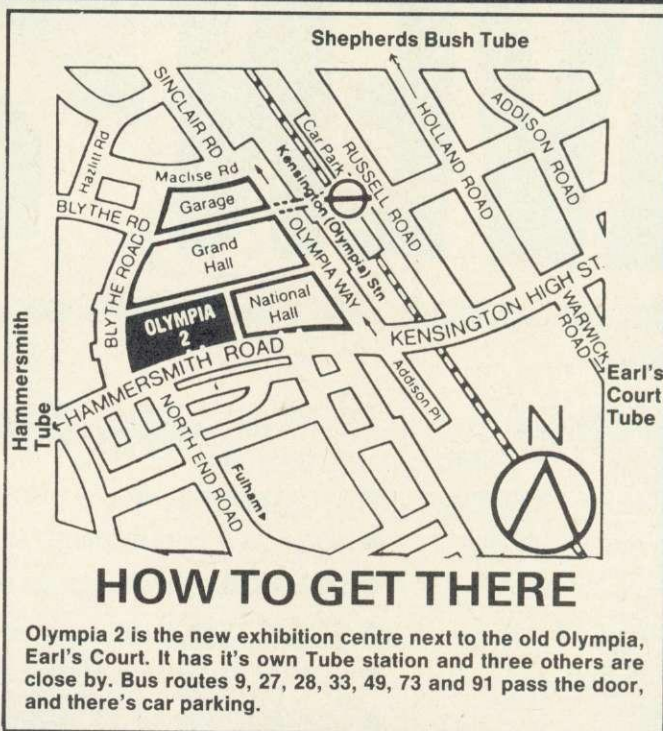

Mouse to go iconographic

MORE details have emerged on the revolutionary AMS Mouse, first announced in last month's AU. It has three buttons on top which, along with the four-way movement, can be programmed to replace up to seven conventional keys on the keyboard.

No applications software is yet available, but AMS has developed basic routines to show how it can be used. The control software is held on a ROM chip and, at its simplest, enables the mouse to move a cursor on the screen, replacing cursor keys or joystick. Other software has been developed that speeds up program editing and similar tasks and includes a routine to work with the *View* wordprocessor.

Perhaps the most exciting development for the mouse is 'icon' software. Anyone who has seen Apple's Lisa or Macintosh will recognise icons as the symbolic screen drawings which represent different functions. For example, moving a file from a filing cabinet icon to a waste-paper bin icon deletes a file!

AMS is hoping software houses will incorporate icon routines into their programs, and its aim is for an integrated mouse package of graphics, spreadsheet and WP.

Phloopy firms up

The Phloopy Data Storage System, first launched in March but not seen since, will receive its first real public airing at the Acorn User Show. It offers the same storage capacity as a single disc drive—100k—yet costs only £99.

Using a continuous loop of magnetic tape, the Phloopy offers a typical access time of three to four seconds. Although not as fast as a disc drive, this is an obvious improvement on normal cassette tapes.

The unit costs £99 plus £26 for the BBC interface and can



The 100k Phloopy continuous tape storage system goes public at the show. It costs £99.

be bought at the Show from Phi Mag Systems. This company is based at the Tregonigie Industrial Estate, Falmouth, Cornwall TR11 4RY. Tel: (0326) 76060.

YES!



A 100k BBC-drive for £99 + VAT

We've done it! We've built a storage system for your BBC Micro with the power and convenience of a floppy disk drive, at a fraction of the price. Interface to the BBC costs £26 + VAT and runs up to 8 drives.

PHLOOPY's special secret

PHLOOPY does not record on a disk, but on a loop of quarter-inch tape contained in a rugged interchangeable cartridge.

The heart of PHLOOPY is a unique "byte-wide" magnetic head, that gives it its speed by recording nine tracks across the tape. Typically, you can access a file in only 3 or 4 seconds.

If you're used to waiting for a cassette tape to trundle programs into your BBC, you'll be amazed at PHLOOPY's performance – up to 100 times faster.

Talking to your PHLOOPY

PHLOOPY's own software makes it respond to standard BBC filing system and Basic commands.

Programs written to run on disk or cassette should run on PHLOOPY without problem.

And because your PHLOOPY drive contains its own

microprocessor – a second computer which does most of the hard work – it puts very little load on the BBC. The on-board computer also checks and automatically corrects any read errors.

Your PHLOOPY Library

PHLOOPY cartridges hold a full 100k of data. You can buy blank cartridges for £3.75 each plus VAT. Many BBC programs will be available on PHLOOPY.



Phi Mag Systems Ltd. PO Box 21, Falmouth, Cornwall TR11 3TD Tel: (0326) 76040

Order Form

- Please send me further details about the PHLOOPY 100k data storage system for the BBC Model B.
- Please send me _____ (qty) PHLOOPY starter pack(s) for my BBC Model B microcomputer, including PHLOOPY drive, BBC interface, leads, connections, operating system in firmware, manual, and two PHLOOPY 100k cartridges, at £147.75 each including VAT, postage and packing. Amount £ _____
- Please send me _____ (qty) packs of 5 PHLOOPY cartridges at £19.75 including VAT, postage and packing. Amount £ _____

I enclose a cheque/PO for £ _____ OR Please debit my Access card Number: _____

Your order will be acknowledged within 10 days, giving a delivery date.

Name _____

Address _____

Town: _____ Post code _____

Send this coupon to: Phi Mag Systems Ltd, PO Box 21, Falmouth, Cornwall TR11 3TD. Telephone: Falmouth (0326) 76040. 14 day money-back option.

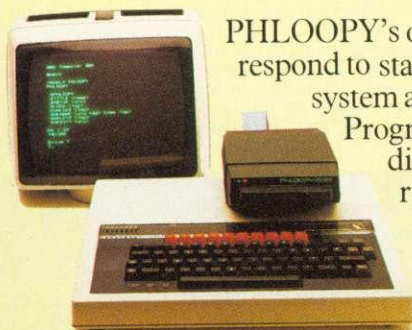

TORCH UNICORN

Designed with a total expansion capability

The Torch upgrade will give you a sophisticated business/professional system. However it doesn't stop there — it gives you the potential to expand — an expansion that no other current system can offer. Today, (not promises of 'one day'!), we are able to offer Hard Disc capability, networking of up to 254 machines, right up to the extra processing power of a 68000 32bit processor with 256K RAM, and optional UNIX operating system. **The potential is here!** The TORCHNET system, (software is included with all systems!), is a cost-effective method of linking office computing equipment in a simple and expandable fashion. TORCH means communication, whether it is inter-room communication, automatic 'home-to-office' communication, or electronic mail allowing a Torch user to initiate telex transfers, send tele-messages, use Electronic Mail (e.g. Telecom Gold), and talk to large mainframes. — **The potential is here!** Hardware is of no use without a suitable range of software, and the Torch can choose from a massive range of business, financial, application and language software. (Did you know that the Torch system has five times more software available for it than the IBM PC!) Why not contact us for your requirements?



TORCH Z80 DISC PACK

The proven upgrade for the BBC Micro. Comprising 2 x 400K disc drive, Z80 processor with 64K of memory, and a CPM compatible operating system. The system is supplied complete with the PERFECT software range including PERFECT WRITER, PERFECT SPELLER, PERFECT CALC, and PERFECT FILE. Full TORCHNET software is also supplied allowing sophisticated networking between other units and Z80 Basic. Disc Pack £699 (a).

GRADUATE
IBM PC Compatible Upgrade for BBC B
Ask for delivery date

The TORCH Z80 SECOND PROCESSOR CARD — for those who already have suitable disc drives. The card is supplied with all the free perfect software and Z80 basic, as detailed above, presenting a very attractive package £299.

TELETEXT

Converts your BBC into a fully fledged Teletext Terminal. In addition to normal reception of Teletext pages, it is able to 'download' software as well as saving standard pages on any of the four TV channels. £196.

ULTRACALC

With advanced features, such as: *Handling of labels and numbers as values, allowing the search of a list by a meaningful name, instead of just a number. *Efficient memory usage allowing large spreadsheets to be constructed. *Variable width columns. Facilities include Sum, Replicate & most mathematical functions. It helps you to create and manipulate *Budgets *Cash-Flow forecasts *Price Lists *Balance Sheets *Time Sheets *Order Entry *Small Databases *Scientific Calculations etc. £69.00.

ACORN COMPUTER SYSTEMS

BBC Model B	£320.00a
BBC Model B + Econet	£389.00a
BBC Model B + DFS	£400.00a
BBC Model B + DFS + Econet	£450.00a
6502 2nd Processor	£175.00b
Acorn Z80 2nd Processor	£264.00a
BBC Teletext Receiver	£195.00a
BBC Dust Cover	£4.00d
Pair of Joysticks	£11.70c
Acorn Bit Stick	£3.28b

TORCH Z80 SYSTEM

TORCH Z80 Disc pack	£699.00a
TORCH Z80 2nd Processor Card	£299.00a
TORCH ZHD240 20Mb	£1995a

UPGRADE KITS

A to B Upgrade Kit	£75.00d
DFS Kit	£95.00 Installation £15.00
Econet Kit	£55.00 Installation £25.00
Speech Kit	£47.00 Installation £10.00

ECONET ACCESSORIES

Printer Server Rom	£41.00b
File Server level 1	£86.00b
File Server Level 2	£216.00b
Clock + 2 Terminators	£95.00b
Econet User Guide	£10.00d
10 Station Lead Set	£27.00d

BBC FIRMWARE

1.2 Operating System	£7.50b
Basic II Rom	£22.00d
View Word Processor Rom	£52.00c
Wordwise W/P Rom	£34.00c
BCPL ROM + Disc	£87.00b
Disc Doctor Utility Rom	£28.00d
Termi Emulator Rom	£28.00d
ULTRACALC Rom (BBC Publications)	£69.00c
Gremlin debug rom	£28.00d
Computer Concepts Graphics Rom	£28.00d
EXMON	£20.00d
TOOL KIT	£20.00d
Printmaster Rom (FX80)	£28.00d
Communicator Rom	£59.00c
COMMSTAR	£29.00b

BBC ANCILLARY HARDWARE

EPROM Programmer	£89.00b
Smartmouth Speech Synthesiser	£37.00b
RH Light Pen	£39.50b
Time-Warp Real-Time	
Clock/Calendar	£29.00b
ACORN IEEE Interface ANK01	£282.00c
Buzzbox Modem	£69.00b
Acorn Prestel Adaptor	£99.00b

PRINTERS & PLOTTERS

EPSON FX-80	£325.00a
EPSON RX-80 FT	£240.00a
EPSON FX-100	£480.00a
EPSON DX-100	£375.00a
Printer Share + Cable Set	£88.00c
JUKI 6 100 Daisy wheel	£350.00a
BROTHER HR15	£350.00a

Accessories:

Parallel or Serial Printer Lead	£8.00d
Serial Printer Lead	£8.00d
Epson Serial Interface 2K 8148	£50.00c
FX80 Dust Cover	£4.00d
Epson Paper Roll Holder	£17.00c
FX-80 Tractor Attachment	£37.00c
PAPER Fanfold 2000 sheets	£13.50b
Ribbon MX80/RX80/FX80	£6.50c
Ribbon MX/RX/FX100	£12.50c
Gemini Delta 10	£300.00a
Grafpad Graphics Tablet	£120.00c
Graphics Plotter/Workstation	£490.00a
Basic Plotter	£270.00a
PSU12	£45.00
PSU24	£79.00
Power Adaptor Cable	£4.50
Software on disc	£3.50
Driller Router	£79.00 Opto Sensor
	£72.00

COLOUR/GREEN MONITORS (leads incld)

Microvitec 1431 14" RGB Std Res	£195.00a
Microvitec 1431 14" RGB/PAL + Sound	£225.00a
Microvitec 1451 14" RGB Med Res	£295.00a
Microvitec 1441 14" RGB Hi Res	£420.00a
Microvitec 2031 14" RGB Std Res	£287.00a
KAGA Vision II Hi Res	£260.00a
KAGA Vision III 12" RGB Super Hi Res	£358.00a
KAGA 12" Green Hi Res	£106.00a
SANYO DM8112CX 12" Green Hi Res	£99.00a
KAGA RGB Lead	£6.50d
BNC Green Screen Monitor Lead	£3.00d
Heavy duty monitor plinth for BBC	£13.50b
Two tier metal plinth	£19.50b
Microvitec plinth	£8.50b
Swivel base for Kaya Green	£19.50b

BBC COMPATIBLES 5.25" DISC DRIVES:

(All include cables, manual + format disc)	
100K (40 Track Teac	£120.00a
100K (40 Track) with psu Teac	£135.00a
200K (40/80 Track) Teac	£155.00a
200K (80 Track) with psu Teac	£175.00a
400K (40/80 Track) Teac	£190.00a
400K (80TDS) with psu Mitsubishi	£200.00a
2 x 100K (40 Track) with psu Teac	£300.00a
2 x 200K (40/80 Track) with psu Teac	£390.00a
2 x 400 (80 Track DS) with psu 40/80	£420.00a
3" Hitachi 100K Drive	£150.00c

ALL PRICES EXCLUDE VAT. Please add carriage 50p

PRINTERS

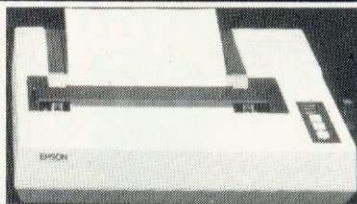

We have a range of printers that will meet most requirements. **EPSON**—the high quality dot-matrix printers that set the standard in the industry—versatile printers that provide the optimum in performance & reliability. The RX80/FT provides all standard printing & graphic functions, (single sheets & perforated paper), with the de-luxe FX80 giving in addition proportional printing, italics, programmable characters etc. The FX100 also allows the use of 15" wide paper. Epson DX100—a new daisy wheel has the hallmark of Epson's quality performance and reliability. The JUKI and BROTHER daisywheels provide a quality normally found in printers costing far more. Printer cables, interfaces, ribbons, paper etc. are all normally available from stock.

GRAPHICS PLOTTER/WORKSTATION

Equally at home in the artists studio, hobbyists workshop, science laboratory, classroom, and production floor, this system has something to offer everyone. The 3-colour graphics plotter provides both precision and versatility. The carriage can be moved with an accuracy of 0.025 cm. over an A4 area — the plotter being able to accept paper and far thicker materials at sizes of up to A3. The basic colour plotter carries three colour pens each of which is software selectable. Various add-ons greatly increase the versatility of the unit, while still retaining the unit's accuracy. The servo controlled drill/router, and a scribe enables drilling, cutting and scribing in various materials. A unique Opto Sensor (using a Hewlett Packard Device) turns the plotter into a high resolution scanning digitiser to read and store whole diagrams, for example, for use in map work. This unique versatile Workstation is supplied complete at £490. Basic Plotter £270.

Our in depth stocks allow us to offer immediate deliveries on most items and our aim is to provide the best available products at competitive prices. In addition to the items listed above we carry extensive stocks of: connectors, connector assemblies, components including TTLs, CMOS, RAMS, EPROMS and CPUs. Spares for the BBC computers are normally available from stock. Orders from government departments, public bodies, hospitals, schools, colleges, universities and recognised PLCs welcome. We specialise in world wide exports. No VAT on exports. Our specially negotiated freight charges to many countries ensure the customer considerable savings on charges.

Everything you need for your BBC Computer

Plus friendly service and professional advice

Accessories:	
Single Disc Cable	£6.00d
Double Disc Cable	£8.50d

3M DISCS with Lifetime Warranty

40T SS/DD	Pkt of 10	£16.00c
40 DS/DD	Pkt of 10	£22.00c
80T SS/DD	Pkt of 10	£26.00c
80T DS/DD	Pkt of 10	£30.00c
3" Double Sided Disc	Each	£4.50c
FLOPPICLENE Drive Head Cleaning Kit		£14.50c
Disc Library Case		£1.90d
Disc File Case 30/40		£8.00c
Disc Lockable Case 30/40		£15.00c
Disc Lockable Case 60/70		£27.00c

EPROMS:

2764-3	£6.50
27128-3	£21.00

SOFTWARE:

ACORN/MERLE BUSINESS SOFTWARE	
Invoicing, Stock Control, Accounts Payable, Accounts Receivable, Order Processing	
Mailing System	Each £22.65d
GEMINI Business-Full Range	
ACORN/SOFT-Full Range	
ACORN LANGUAGES including BCL, LISP	
S.Pascal Disc	£17.30d
BCPL Calculations Disc	£17.30d
FORTH with Manuals	
BBCSOFT Full Range	
PROGRAM POWER-Full Range	
BEEBUGSOFT Full Range	
Wordwise Spellcheck Disc	£16.50d
Design	£16.50d
Superplot	£16.50d
Masterfile (Databases)	£16.50d
Teletext Pack (Mode 7 Graphics)	£16.50d
Replica II	£10.50d

CASSETTE RECORDERS:

SANYO DR 101 Data Recorder	£30.00b
Datex Sim Line	£20.00c
BBC Tape Recorder	£28.50b
Cassette Lead	£3.00d
Computer Grade C-12 cassette	£0.45d
Computer Grade Cassette 10' off	£4.00c
Philips Mini-data cassette	£3.00d

BOOKS (NO VAT) p&p £1.50/book

Let Your BBC Teach U to Program	£3.50
BBC Micro Revealed	£3.00
100 Programs for the BBC	£6.95

30 Hour Basic	£5.95
35 Educational Progs	£6.95
6502 Applications	£9.75
6502 Assembly Lang Programming	£12.95
6502 M/Code for Beginners	£5.95
6809 Assembly Lang Programming	£13.95
Advanced Prog Tech for BBC	£7.95
Advanced 6502	£10.25
Advanced User Guide	£12.50
Assembly Lang Pro on the BBC	£7.95
Assembly Lang for the BBC	£7.95
Assembly Lang Prog for Electron	£4.00
Assembly Lang Programming Birnbaum	£8.95
Basic Prog on the BBC Crier	£5.95
BBC Basic	£5.95
BBC Basic for Beginners	£6.95
BBC Micro for Beginners	£6.95
BBC Micro Disk Companion	£6.95
BBC Micro Expert Guide	£6.95
BBC Micro Graphics & Sound	£6.95
BBC Micro in Education	£6.50
BCPL User Manual	£15.00
Beyond Basic	£7.25
Creating Adventure Progs	£6.95
Creative Graphics	£7.50
DIY Robotics & Sensors	£6.95
Discovering BBC M/Code	£6.95
Forth	£7.50
Friendly Computer Book	£6.95
Graphics on the BBC Micro	£6.95
Graphs & Charts	£7.50
Interfacing the 6502	£10.95
Intro BBC Micro	£5.95
LISP	£7.50
Making Music on the BBC Computer	£5.95
Micro Basic Sound Graphics	£7.95
MOS Memory Data Book	£3.95
Prog the BBC Micro	£6.50
Programming the 6502	£9.95
Programming the 6809	£11.35
Programming the 8086/8088	£10.95
Programming the BBC	£6.50
Programming the Z80	£9.95
Start Prog with Electron	£5.00
Structured Programming	£6.50
The Electron Book	£7.95
TORCH Z80 Disc Pack User Guide	£10.00
TTL Data Book Vol-1	£9.00
TTL Data Book Vol-2	£8.50
BBC User Guide	£15.00
Using BBC Basic	£10.00
Using Floppy Disks	£6.95
Using the 6502 Assembly Lang	£14.50
Z80 Applications Book	£10.95

DISC DRIVES

A full range of disc drives fitted with quality Japanese slimline mechanisms, (such as TEAC, MITSUBISHI etc.) are supplied ready to connect to your BBC, and come complete with necessary cables, formatting disc, manual etc. TEAC & MITSUBISHI mechanisms can operate in single and double density modes. The switchable disc drives give the user flexibility, by allowing access to both 40 & 80 Track discs. We have a full range of diskettes, variety of disc storage cases, disc-drive cables. The Floppiclene head cleaning kit is the



**Switchable
400K and 800K
Drives now in stock**

ideal way to ensure optimum performance of your drives. The use of disposable cleaning discs eliminate the risk of recontamination and abrasion, and ensure continuous data capture and transmission.

SCOTCH 3M FLOPPY DISCS

We now stock the high performance yet economical 3M range. Due to advanced production techniques, a higher standard has now been reached, enabling Scotch to guarantee error free performance for life.

NEW ACORN PRODUCTS:

We can now supply the following recently released ACORN products from stock.

Z80 Second Processor **£264(a)**

6502 Second Processor **£175(b)**

Bit Stick **£328(b)**

Prestel Adaptor **£99(b)**

ACORN IEEE INTERFACE

A full implementation of the IEEE-488 standard, providing computer control of compatible scientific & technical equipment, at a lower price than other systems. Typical applications are in experimental work in academic and industrial laboratories. The interface can support a network of up to 14 other compatible devices, and would typically link several items of test equipment allowing them to run with the optimum of efficiency. The IEEE Filing System ROM is supplied. **£282.**

VIDEO DIGITISER

Supplied complete with integral power supply, and ROM based software, it interfaces with the computer via the 1Mhz bus. A signal supplied from any standard video camera/recorder will provide a high quality picture, with eight different grey scale levels. The friendly yet sophisticated menu-driven software comes complete with an Epson printer dump. **£218(a)**

MONITORS:

MICROVITEC— a range of British Made DTI/ACORN Approved Std/Med/Hi-resolution RGB colour monitors that have a consistent, reliable performance. Also available in RGB/PAL/SOUND versions. The KAGA range provides a similar performance in 12" screen format. Our Japanese manufactured Hi-Res green screen SANYO is an ideal solution for high clarity 80 column text display. The KAGA green screen, with its 'chemically etched' anti-glare screen for the discerning user. All monitors are supplied with suitable leads at no extra charge.

GRAFPAD

A low cost graphic-tablet offering the performance and durability required for the business, industrial and educational user. It is small, accurate & reliable. Working area: 240 x 192mm + Menu area. **CAD program £120(g).**

Continued on page 22

TECHNOMATIC LTD.

All prices exclude carriage & VAT. Please add carriage as indicated and add 15% VAT to the total order value. For fast delivery telephone your order quoting VISA or Access card or official order number
Minimum telephone order £5).

unless indicated as follows: (a) £8 (b) £2.50 (c) £1.50 (d) £1.00

PRINTMASTER ROM FOR THE FX80

This sophisticated printer handling ROM will support the Epson MX, RX and FX range of printers, and includes many useful features. You no longer need several printer ROMS as 'this one does it all!'. **PRINTMASTER** will dump in all modes. Three types of screen dumps are available, the most flexible being ***GDUMP** which operates in any graphics mode, displaying the colours as shades. Any part of the screen can be printed at any position on the paper in any one of the four orientations. The dump can be magnified by any factor x2, x3, x4 etc. A special feature allows true Mode 7 screen dumps with **TELETEXT** text and graphics, colours (as shades), double height etc. ***TDUMP** allows any text mode to be dumped and ***FDUMP** will print contents of a file on disc while the computer can be doing other things. The ***DEFINE** function allows the user to define his own characters and the facility to save them. Commands can be called from Basic programs and language ROMS. **All for only £28 (c).**

VIEW PRINTER DRIVER FOR EPSON FX80

This printer driver will enable the user to fully exploit the potential of the highly versatile Epson FX80 printer making text presentation both impressive and attractive.

A choice of 12 HT code options covering the full range of FX80's fonts is made available to the user. One of the options allows the user to call up the user defined characters stored in the printer buffer. However, the most powerful feature of the driver is its ability to offer the use of multiple HT codes in the same piece of text.

The booklet supplied with the driver includes illustrative examples and shows how to prepare and store formats for frequently used documents. Supplied on disc **£7.00(c)**

MAIL ORDER TO: 17 Burnley Road, London NW10 1ED
(Tel: 01-208 1177 (4 lines))

SHOPS AT: NW London: 15 Burnley Road, London NW10 1ED
(Dollis Hill) 2 mins walk, ample car parking space)

West London: 305 Edgware Road, London W2. Tel: 01-723 0233
(Near Edgware Road)

EPROMER II

Our current version of the highly popular Eprom programmer is now being enhanced to provide more and better facilities for easy programming by the user. The software will maintain its superiority over all currently available similar programmers. The range of eproms handled has been widened, to include

the eproms with lower programming voltage and eproms which can be programmed using the fast algorithm. Control of all operations has been moved to the keyboard. The screen display has been improved to give more information. The screen editing facilities have also been modified to simplify the data entry.

Preliminary Information

- The new Eprom Programmer will now program 2516, 2532, 2564, 2716, 2732, 2764, 27128 and 27256 + 5v eproms, and all but the 27256 in a single pass.
- The programmer will be supplied with integral power supply, and interfaces with the BBC via the 1MHz bus. It is fully buffered and complies with Acorn protocols. There is no power drain from the computer.
- No knobs or switches to fiddle with — total control from the keyboard
- Fully software driven with easy to understand instructions displayed on the screen.
- Eprom type selectable from the keyboard
- Selectable programming voltage 25/21/12.5V
- Defaults to normal programming with high speed algorithmic programming selectable, for a device with suitable capability.
- Continuous screen display of eprom type, option and address range selected.
- Full screen editor with HEX or ASCII input. Constant display of logical eprom address.
- Can read, blank check, program and verify at any address/addresses on the eprom.
- Full Tape/Disc filing facility.
- Several basic programs can be entered on a single eprom and called up with individual name.

EPROM ERASERS



UV1T Eraser with built-in timer and mains indicator. Built-in safety interlock to avoid accidental exposure to the harmful UV rays. It can handle up to 5 eproms at a time with an average erasing time of about 20 mins. **£59 + £2p&p.**
UV1 as above but without the timer. **£47 + £2p&p.**

Now Available

GEMINI'S DATAGEM

The Definitive Random Access, 24K ROM based Database Management System

This is the first truly flexible database for the BBC micro which will have an application to offer in almost any field one can imagine.

- The file size is almost unlimited (Maxm. 10 Mbytes)
 - System will support up to 4 drives
 - Maxm. No. of records/file: 5000
 - Maxm. record size 6K
 - Maxm. No. of fields 62.
 - 9 level hierarchical search system with facilities to store results of searches. Searches can be any one of the following: Search, Include, Exclude, Combine, Common or Difference.
- £112.00 + £2 carriage**

SPECIAL OFFER
EPSON FX80
PRINTER
ONLY £325

including BBC printer lead
Twelve Months full warranty.

'TIME-WARP' REAL-TIME-CLOCK/CALENDAR

A low cost unit that opens up the total range of Real-Time applications. With its full battery backup, possibilities include an Electronic Diary, continuous display of 'on-screen' time and date information automatic document dating, precise timing & control in scientific applications, recreational use in games etc — its uses are endless and are simply limited by one's imagination. Simply plugs into the user port — no specialist installation required — No ROMS. Supplied with extensive applications software. **Please phone for details.**
£29.00 + £2.50 carriage.

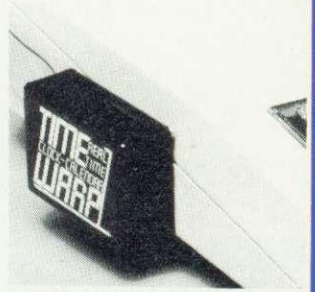

SMARTMOUTH

The original 'infinite speech'.
Still the best.

A ready built totally self contained speech synthesiser unit, attractively packaged with built-in speaker, AUX output socket etc. — no installation

problems! It allows the creation of any English word, with both ease and simplicity, while, at the same time being economical in memory usage. You can easily add speech to most existing programs vocabulary, whole applications commercial, recreational etc. no need to plug into the SMARTMOUTH is supplied with demo and development programs on cassette, and full software instructions. **£37 + £2.50 carriage.**

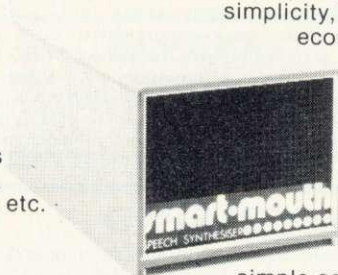

BUZZBOX

This is a full specification, direct connect modem, with both Originate and Answer modes, allowing access to the many databases, bulletin boards, as well as inter-computer communications. The modem conforms to the international CCITT V21 300/300 Baud standard. (NOTE: Not suitable for PRESTEL). Having full BT Approval, it connects directly to the telephone line, for optimum performance. Being battery powered, it is totally portable (optional power supply available). **£69.** BBC Lead **£3.50.** External PSU **£8.00.**

BEEBUGSOFT

A professional range of Firmware/Software to suit both the advanced programmer and the user. From the well known 'EXMON' and 'TOOLKIT' to the WORDWISE SPELLCHECK.

MORE FROM
TECHNOMATIC
ON PAGES...
20 & 21

MAIL ORDERS TO: 17 Burnley Road, London NW10 1ED
(Tel: 01-208 1177 (4 lines) Telex 922800)

SHOPS AT: NW London: 15 Burnley Road, London NW10 1ED
(Dollis Hill 2 mins walk, ample car parking space)

West London: 305 Edgware Road, London W2. Tel: 01-723 0233
(Near Edgware Road)

TECHNOMATIC LTD.

All prices exclude carriage & VAT. Please add carriage as indicated and add 15% VAT to the total order value. For fast delivery telephone your order quoting VISA or Access card or official order number (Minimum telephone order £5).

CARETAKER

Basic Utility
Rom

Print master

(epson)

commands:

- *CURSOR
- *EXCHANGE
- *EXPAND
- *INSERT
- *KEYLOAD
- *KEYSAVE
- *LVAR
- *MERGE
- *MOVE
- *NORMALKEY
- *NOTAB
- *PARTSAVE
- *RENUMBER
- *RETRIEVE
- *SINGLEKEY
- *SQUASH
- *STATUS
- *TABSTOPS

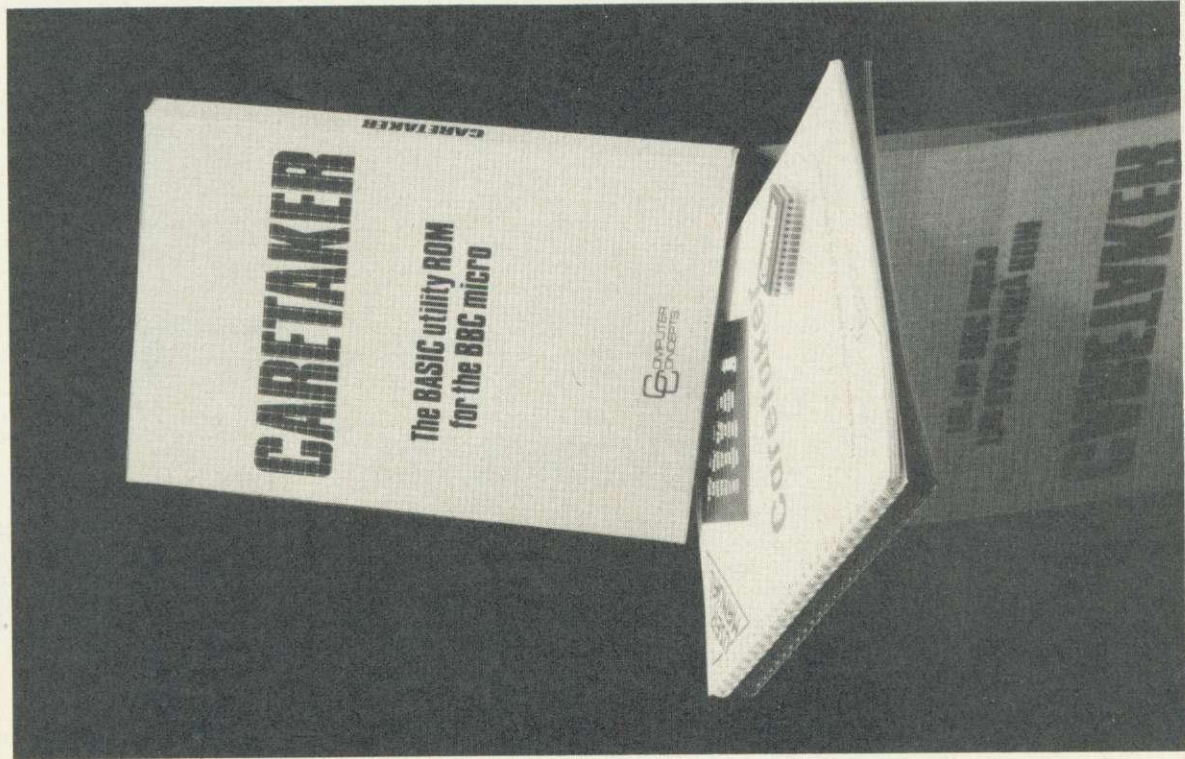

commands:

- *DEFINE
- *FDUMP
- *FONT
- *GDUMP
- *GPRINT
- *INITIALISE
- *ITALIC
- *LINCH
- *LINESPACE
- *MARGIN
- *PAGELEN
- *PCODE
- *PROPORTION
- *STYLE
- *TAB
- *TDUMP
- *TEXT
- *TPRINT
- *ULOAD
- *UNDERLINE
- *USAVE
- *WINDOW
- *WVVALS

Computer
Concepts



Please write or 'phone for further details, Computer Concepts, Gaddesden Place,
Hemel Hempstead, Herts HP2 6EX (0442) 63933

B-BASE: £25—8 Great Features

WHAT IS A DATABASE?

It is a FILE which contains RECORDS. Records consist of a number of FIELDS containing the information—an analogy can be drawn with a card index in which a box of cards is the file. Each card is a record and each line on the card is a field.

SPECIFICATION

- 1) Random Access—disc based, single or dual drives
- 2) File Size—99K (40 track), 199K (80 track) —65,000+ records
- 3) Record Size—up to 2048 characters and 200 fields
- 4) Field Size—up to 254 characters with complete line scanning
- 5) Access any record using Primary Key in 2 seconds
- 6) Holds—1200 NAMES AND ADDRESS records on 100K disk
- 7) Search—500 records on 5 fields in 60 seconds
- 8) Sort—500 records on 3 fields in 60 seconds

SYSTEM FEATURES

SEARCH PARAMETERS = , < , > , > = , < = , < > , INSTR
 CALCULATE—Global or local totals and functions using any valid BBC expression
 POWERFUL PRINTOUT OPTION—Eliminates need for separate mailing program, Parallel/Serial Printout allows setting of printer control codes, line spacing, tabulation, Headings etc, plus label printing with horizontal and vertical tab control.
 REDEFINE—Titles, field widths, number of fields etc.
 TRANSFER—Records from one file to another
 SEARCH LISTS—Allow creation of sub-Databases within main Database but without having to save data again.
 DATE FORMATS—6 formats for print out
 All timings and sizes are relative to ACORN DFS. Compatible with ACORN DFS, WATFORD 1.3 and latest AMCOM DFS.

Send S.A.E. for detailed data sheet

All Disc Software now available on 3" disc—add £3 to printed prices

REPLICA II: £12.00.

The original REPLICA set a very high standard so the specification we set our chief programmer included some impossible features. In fact ACORN state that some of the things that we have done are impossible, it just took us longer that's all. REPLICA II transfers most cassette based programs to disk, even more than REPLICA. When you buy disk drives you do not have to throw away expensive cassette based programs.

REPLICA II transfers 'LOCKED' programs, programs loading as files, programs that load below &EOO, those with up to 6 sections and those up to &6E in length eg adventure programs. No waiting for 6 minutes whilst adventure programs load.

REPLICA II is very easy to use. The user enters a name, how many sections and whether CHAIN*, RUN or *LOAD to load the first section. Press play and let the program do the rest, even a menu. Think how much it will cost you to buy just 1 disk version of your favourite program—REPLICA II which will hold up to 16 programs limited only by the disk capacity.

CLARES NO1 IN UTILITY SOFTWARE!

THE KEY: £12.95



The original disk utility program for the BBC that provides the user with the tools to explore the disk environment and use it to its best advantage. The programs are:

- 1) FORM40—Formats and verifies 40 track disks.
- 2) FORM80—Formats and verifies 80 track disks.
- 3) BACKUP—Allows backup copies of your valuable disk to be made.
- 4) EDITOR—Enables the user to read the disk sector by sector and to alter programs on the disk, even most protected and unlistable ones. More fun than any adventure game.
- 5) RETRIEVE—Allows the user to recover data or programs that have been accidentally erased or damaged by a head crash.

Every disk owner should have one. Recommended by: WHICH MICRO; EDUCATIONAL COMPUTING etc.

JOYSTICK UTILITY: £6.00



Converts non joystick programs to work with joysticks. Works with any program using INKEY (-) in Basic or machine code, to detect movement, which applies to most programs. The routine is relocatable and sensitivity of the joystick can be varied. Compatible with most games, including Acornsoft. Very easy to use, just press the keys you want to transfer. The machine code can be saved as a block of just 100 bytes. Supplied on cassette but can be transferred to disk.

SHADOW: £8.00

SHADOW is a tape cloning program that makes security copies of your valuable cassette software. SHADOW works with 99% of all known programs including those with sections at 300 BAUD and those that load as files. SHADOW will handle programs with any number of sections and it will work with any of the current operating systems

including 0.1, 1.0 & 1.2 SHADOW is the definitive tape backup system and as a bonus you also get 'INSPECTOR' on the same tape. This allows you to view all areas of memory, search and alter bytes, etc. Colour coding helps to simplify memory usage.

"It is a condition of sale that this program is not used for piracy."

JOYSTICKS: £17.95

BBC JOYSTICKS—Fully proportional joysticks in smart, sturdy injection moulded cases. 1.5 metres of cable, long life mechanism gives precise operation. British made.



All prices inclusive of VAT & Carriage—NO EXTRAS!

We're not short of Utility Software.

clares
MICRO SUPPLIES

AU9
98 Middlewich Rd.,
Northwich, Cheshire CW9 7DA
Tel: 0606 48511
Open 9—5pm Monday—Friday



Clares
UTILITY SOFTWARE

DOT MATRIX PRINTERS



ALL PRINTERS HAVE CENTRONIC PARALLEL INTERFACE UNLESS OTHERWISE STATED. ALL PRINTERS HAVE HI-RES. DOT ADDRESSABLE GRAPHIC MODE. PLEASE SEND SAE FOR FULL DETAILS.

EPSON

FX 80 160 CPS, 10" wide fric. & pin feed £344 + VAT = £395
 FX 100 160 CPS, 15" wide, fric. & tract. feed £431 + VAT = £495
 RX80 F/T 100 CPS, 10" wide, fric. & tract. feed £261 + VAT = £299
 RX80T 100 CPS, 10" wide tractor feed £294 + VAT = £269
 LO1500: 200 CPS Letter quality printer £29 + VAT = £33
 8148: RS 232 Interface for FX and RX printers £50 + VAT = £59
 8148: RS232 Interface with 2K buffer, con.xoft £7 + VAT = £7
 Ribbon Cartridge for RX80 FX80 & MX80 £12 + VAT = £13
 Ribbon Cartridge for FX100 & MX100

STAR

Gemini 10X 120 CPS, 10" wide fric. & tract. feed £200 + VAT = £229
 Gemini 15X 120 CPS, 15" wide fric. & tract. feed £295 + VAT = £339
 Delta 10 160 CPS, 10" wide, fric. & tract. feed £327 + VAT = £375
 Delta 15 160 CPS, 15" wide, fric. & tract. feed £414 + VAT = £475
 Radix-10 200 CPS, NLO, 16K Buffer Par. & serial interface, downloadable characters, incredible value at £431 + VAT = £495
 Radix-15 15" wide version of Radix-10 £518 + VAT = £595

SEIKOSHA

GP100A: 50 CPS, 10" wide, tractor feed £156 + VAT = £179
 GP250X: 50 CPS, 10" wide, tractor feed, ser. & p.p. £196 + VAT = £225
 GP100V: 30CPS, 10" wide, VIC 20 & 64 interf. £174 + VAT = £199
 GP500A: 50 CPS, 10" wide, tractor feed £187 + VAT = £215
 GP550A: 50 CPS, 10" wide friction & tract. correspondence quality £234 + VAT = £269
 GP100AS: Serial interface, ideal for Spectrum with microdrive £174 + VAT = £199

SHINWA

CP80 80 CPS, 10" wide friction & tract. feed £187 + VAT = £215
 Spare ribbon cartridge for CP80 £6 + VAT = £6

RITEMAN

Compact 120 CPS, 80 col fric. & tract. feed £200 + VAT = £229

CANON

PW1080A 160 CPS, 10" wide, 27 CPS NLO 24 x 16 matrix £283 + VAT = £325
 PW1150A 160 CPS, 15" wide, 27 CPS NLO 24 x 16 matrix £347 + VAT = £399

COLOUR PRINTERS

Seikosha GP700A 7 colour, 50 CPS printer £47 + VAT = £399
 Canon PJ1080A 7 colour, 40 CPS ink jet printer £391 + VAT = £449
 CPP40 40 column 4 colour battery operated £118 + VAT = £135

ALL OUR PRINTERS HAVE 1 YEAR WARRANTY

BBC MICROCOMPUTER SYSTEM

WE ARE AN OFFICIAL BBC COMPUTER DISTRIBUTOR
 DEALER ENQUIRIES ARE WELCOMED

Acorn Electron £199^{INC} VAT

WE SUPPLY FREE 30 HOUR BASIC BOOK AND A DUST COVER WITH EACH BBC COMPUTER

BBC is the best microcomputer currently on the market. 32K RAM, 32K ROM, 8 modes of operation, full colour, full-size keyboard, internal expansions such as disc interface, speech synthesizer, Econet interface - In short it is a personal computer capable of expanding into a small business system.

BBC Microcomputer Model B	£348 + VAT	£399
BBC Mod B - disk interface	£409 + VAT	£469
BBC Mod B - Econet interface	£389 + VAT	£447
BBC Mod B - disk and Econet interfaces	£450 + VAT	£517
BBC cassette recorder and lead	£200 + VAT	£264
BBC dual 800K disk drive	£699 + VAT	£803
Torch Z80 disk pack including Z80 2nd processor, 65K RAM and CPN operating system - Free Perfect Software	£696 + VAT	£799
BBC Teletext receiver (Aug)	£196 + VAT	£225
BBC cassette recorder and lead	£26 + VAT	£29
Disc interface kit (free fitting)	£84 + VAT	£96
Mod A to Mod B upgrade kit	£70 + VAT	£80
Fitting charge for A to B upgrade kit	£30 + VAT	£23
Games paddles	£11 + VAT	£12
12" Monochrome monitor incl. cable	£99 + VAT	£102
14" Colour monitor incl. cable	£199 + VAT	£222
User guide	£10 + VAT	£10
Econet interface (free fitting)	£60 + VAT	£69
Speech interface (free fitting)	£47 + VAT	£54
BBC disk manual - formatting disk	£30 + VAT	£34
Parallel printer cable	£10 + VAT	£11
BBC word processor (view)	£52 + VAT	£59
BBC 40K language cassette	£15 + VAT	£17
BBC Lisp language cassette	£15 + VAT	£17

APPROVED ECONET SERVICE CENTRE
 WE STOCK A LARGE RANGE OF SOFTWARE FOR BBC MICRO INCLUDING AK, ARMSOFT, BBC, SOFTWARE, LONGMANS SOFTWARE PLEASE SEND LARGE STAMPED ADDRESSED ENVELOPE FOR FULL DETAILS

TORCH Z80 2nd PROCESSOR For only £347 + VAT

Torch 2nd Processor Z80 is supplied with perfect writer (a powerful Word Processor), perfect speller (spelling checking program - I should have used one for making this advert!), Perfect Filer (A Database Program), Perfect Calc (Spread Sheet). It includes 64K memory (Almost 60K available to user). Fits inside BBC Computer.

Z80 2nd Process - Perfect Software	£347 + VAT = £399
Z80 Processor - Perfect Software + Dual 800K Disk Drives	£695 + VAT = £799

GUARANTEED LOWEST PRICES

100% BBC COMPATIBLE MITSUBISHI AND TEAC SLIMLINE DISK DRIVES



NEW LOWER PRICES!

These drives are supplied ready cased with all the necessary cables, formatting program and User Guide.
 There are some very useful utilities included on formatting disc e.g. DISASSEMBLER. This is 6802 machine code disassembler.
 * DUPE - To copy and rename a file on disc.
 * FORMAT - Formatting program for 40 & 80 tracks.
 * FREE - This utility provides a disk usage analysis.
 * MDUMP - Enables you to display and modify any part of BBC memory.
 * MERGE - Merge a number of text files into one file.
 * RELOCATE - Downloads a basic program to 4000.
 * SDUMP - Screen dump for EPSON in all graphic modes.
 * VERIFY - Verifies every sector on a disk.
 * MENU - A flexible menu program.

Single drive 100K 40 trks, single Sided	£147 + VAT = £169
Dual drive 200K 40 trks, single sided	£286 + VAT = £329
Single drive 200K 40 trks, double sided	£173 + VAT = £199
Dual drive 400K 40 trks, double sided	£330 + VAT = £379
Single drive 400K 80 trks, double sided	£199 + VAT = £229
Single drive 400K 40/80 trks, switchable, DS	£217 + VAT = £249
Dual drive 800K 80 trks, double sided	£382 + VAT = £439
Dual drive 800K 40/80 trks, switchable, DS	£408 + VAT = £469

All above drives are low power slimline, (0.3 A typ. at 12v and 0.4 A at 5v per drive). Normally extra power supply is not required, the BBC Computer power supply is designed to drive two low power drive (IT IS NOT DESIGNED TO DRIVE INTERNAL ROM BOARD).
 40 Track SS/DD diskettes (10 Box) £18 + VAT = £20
 40 Track DS/DD diskettes (10 Box) £23 + VAT = £26
 80 Track SS/DD diskettes (10 Box) £28 + VAT = £32
 80 Track DS/DD diskettes (10 Box) £30 + VAT = £34
 ALL ABOVE DISKETT ARE CERTIFIED EITHER MEMOREX OR DETALIFE.

YOUR CONTACTS AT AKHTER ARE

DEALER/BULK ENQUIRIES	HAMAYUN MUGHAL
TELEPHONE ORDERS	PAULA HAYES
DEALER ORDERS	TONY GLOVER
BUSINESS SYSTEMS ENQUIRIES	DENNIS SLITCH
EXPORT ENQUIRIES	MAHAMAD EDIB
ECONET SYSTEM TECHNICAL ENQUIRIES	ALAN LAFFOLEY
ACCOUNTS	CARON ANDREWS
DESPATCH	PAUL SWIFT
REPAIRS	JOHN MAULE

Prices Correct at the time of this advertisement going to press.

BUSINESS SYSTEMS



APRICOT - SIRIUS - SANYO IBM - TEXAS - TORCH

APRICOT "Portable Executive Computer" 16 Bit Micro, 256K RAM, up to 1.44 megabytes floppy disk storage, 3 1/2" Sony disks. Portable brief case styling. Modem with auto dialler (optional) hard disk optional. Vast software library (compatible with Sirius 1).
 Apricot with Single Drive and Monitor £1690 + VAT
 Apricot with Double Drive and Monitor and Free Printer or 2nd Monitor £1890 + VAT

SANYO PROFESSIONAL COMPUTER
 16 Bit Micro 128K RAM expandable to 256K. Single or Double Disk Drive built in full colour graphics (640 x 200 pixels in 8 colours) IBM compatible. Free software, Sanyo MBC 550 128K RAM single drive and free software including Wordstar and Calcstar £1,499 + VAT
 Sanyo MBC555 128K double drive and free software including Wordstar, Calcstar, Infostar, Dalastar etc. £999 + VAT

SIRIUS 1 Sirius 1 Computer with 128K RAM and 1.2 megabyte Floppy disc storage including CP/M 86, MS DOS and Microsoft Basic £2195 + VAT
 Sirius 1 Computer with 256K RAM and 2.4 megabyte Floppy disc storage including C/M 86 MS DOS & Microsoft Basic £2895 + VAT

TORCH
 CF500 COMPUTER with colour monitor includes Twin 400K disks, Torchnet Operating System free perfect software (perfect writer, perfect speller, perfect calc, perfect filer), Torchmail Plus (Electronic Mail), Torch Mars (Financial modelling with graphics), Torchitel (Viewdata Access System), Executive Aid (Menu System)
 Datalink 800 Link to outside mainframe services i.e. Database (Gold) £2950 + VAT

TEXAS INSTRUMENTS PROFESSIONAL COMPUTER
 T1 502 Dual 320K RAM drives 256K RAM. Up to 10 megabyte on board storage possible. T1 speech command hardware option brings a new level of user friendliness to computing. Allows voice operated keyboard control. (Optional) Price £2650 + VAT

MAINTENANCE CONTRACTS ARE AVAILABLE.

DAISYWHEEL PRINTERS



JUKI 6100

20 CPS Bi-Directional Logic seeking 10.12.15 CP1 + PS Spacing, 2K buffer, selling Daisywheel, Singer sheet feeder unit, Tractor Unit £349 + VAT = £395
 RS 232 Interface £95 + VAT = £109
 Spare Daisywheel £17 + VAT = £19

BROTHER HR-15

13 CPS Bi-directional, 10.12.15 CP1 + PS Keyboard Unit £344 + VAT = £395
 Single Sheet Feeder Unit £139 + VAT = £159
 Tractor Unit £127 + VAT = £249

DAISY STEP 2000

20 CPS Unidirectional, 10.12.15 CP1 £260 + VAT = £299

SMITH CORONA TP1

12 CPS, 10.12, CP1, unidirectional £208 + VAT = £239

PROFESSIONAL MONITORS

*SANYO
 *MICROVITEC
 *FIDELITY
 *PHOENIX



SANYO
 DM8112 12" Green screen 18 MHz Hi-Res £86 + VAT = £99
 DM2112 12" Green screen 15 MHz Monitor £66 + VAT = £75
 CD3125 14" RGB Normal Res. Colour Monitor £173 + VAT = £199
 CD3117 14" RGB Medium Res. Colour Monitor £286 + VAT = £329
 CD3115 14" RGB High Res. Colour Monitor £391 + VAT = £449

MICROVITEC CUB

1431 MS 14" RGB Normal Res. Colour Monitor £173 + VAT = £199
 1451 MS 14" RGB Medium Res. Colour Monitor £321 + VAT = £369
 1441 MS 14" RGB High Res. Colour Monitor £417 + VAT = £479

FIDELITY Colour Monitor

CM14 14" RGB RGBY Composite sound col £187 + VAT = £215

PHOENIX

Phoenix High Res. 12" Green Monitor £66 + VAT = £75
 Phoenix High Res. 12" Amber Monitor £69 + VAT = £79



AKHTER INSTRUMENTS LTD. T/A

COMPUTER GROUP

28/29 BURNT MILL
 HARLOW, ESSEX. CM20 2HU U.K.
 Tel. HARLOW (0279) 443521 Telex: 818894 AKHTER G

ORDERING INFORMATION:

We accept official orders from UK Government and Education establishments. Carriage is Free (UK only) for normal delivery. If express delivery is required please add £8.00 + VAT per parcel. We accept telephone orders on Barclay and Access card please ring (0279) 443521 (10 lines). All cheques made payable to "AKHTER INSTRUMENTS".

N.B. ALL VAT INCLUDED PRICES ARE THE CORRECT PRICES. EXCL. VAT PRICES HAVE BEEN ROUNDED UP TO NEAREST POUND.



SEE US AT
 The 2nd Official
 Acorn User
 Exhibition
 OLYMPIA
 16-19 AUGUST
 1984
 Stand 73 -

OPENING HOURS: MON-FRI 9am-6.30pm, SAT 10am-5pm
 We welcome callers, no parking problems.

UNSCRAMBLING THE AIRWAVES

Robin Mudge kits you out to decode those mysterious radio signals

SHORT-WAVE radio listening used to be very popular. Back in the thirties there were almost as many radio magazines as there are computer magazines now. Today modern receiver design has packed the power of those gigantic World War Two radios you used to be able to get in government surplus stores into a tiny compact portable. In this article we'll look at how you can use a BBC micro to untangle some of the blips and blops picked up by this new breed of 'transistor'.

Modern short-wave radios are small and powerful. Even the minuscule Sony 1c9600 is a full-facility receiver with the kind of pulling power that brings in stations from all over the world. When you listen to one of these sets you'll hear mixed up with the hundreds of foreign voices a strange collection of dots, dashes and chirping sounds. It is these normally unintelligible signals that are potentially the most interesting and, using a BBC micro, you can begin to unscramble some of them.

The big question is, why bother with all these special codes when it is easy these days to talk over the radio? The trouble is that transmitting voice-radio telephony - uses up a lot of radio space, and there is only a limited amount. Transmitting messages by radio telegraphy and radio teletype makes more efficient use of the radio frequencies and over long distances is more reliable. Often interference makes voice reception very difficult whereas telegraphic and teletype signals can still be decoded successfully. Because of this, those blips, blops and chirping noises often carry very interesting messages.

Before looking at how to receive and decode these messages a pause for some history and explanation. Radio telegraphy started in 1901 when Guglielmo Marconi transmitted the first transatlantic radio signal. He used a dot-and-dash code invented earlier by Samuel Finlay Morse. In the Morse code each letter and number is represented by a series of dots and dashes: the letter A is · — and C — · — ·.

Soon people wanted to transmit messages faster and use machines for automatic sending and receiving. The Morse code couldn't be used for this because it was difficult for a machine to recognise where one letter ended and the next started. Radio Teletype (RTTY) codes get over this problem by using a sort of binary word. Each 'word' is made up of a number of units of equal length. The asynchronous Baudot code (baud) is most commonly used today. This is made up of five data units representing alphabetic information, and because the receiver is not synchronised with the transmitter a start and stop unit are added. Each of the five data units can have a value of 1 or 0. In radio terms these are called 'mark' and 'space' respectively so, looking at the five data units, an 'a' is 00111 and c is '10001'. RTTY signals are normally transmitted at a number of different speeds. These are 45, 50, 57, 75, 100 and 110 baud.

So what do you need to turn these codes into something readable? The first thing apart from a BBC micro is a short-wave radio. You don't have to have the latest thing but you do need a good set that must be able to receive Single Side Band (SSB) signals. SSB signals are another way that radio people make better use of the available frequencies, but they can't be received without a special radio. All the new generation sets have this facility.

The Icom IC R70 is one of the top-range sets. It costs about £550 and has almost every facility that a short-wave radio fan could wish for. There are a lot of receivers between this price and about £200 and a visit to the local amateur radio shop or a glance through some of the radio magazines will introduce most of them. Two portables are worth while considering - the Sony ICF-7600D at about £160 and a British one, the Uniden Communication Receiver 2021 at about £200. Both are full-facilities short-wave radios and offer good reception on the FM band for ordinary radio programmes as well.

Next is an aerial. The two portables come with telescopic aerials but these aren't good enough to pull in the really distant stations. The simplest kind is a long piece of wire (the longer the better), either stretched from a convenient window to a nearby support or hung down the side of the house. A really neat indoor one is the Datong Active Receiving Antenna. This is only three metres long but because it uses active components is very effective

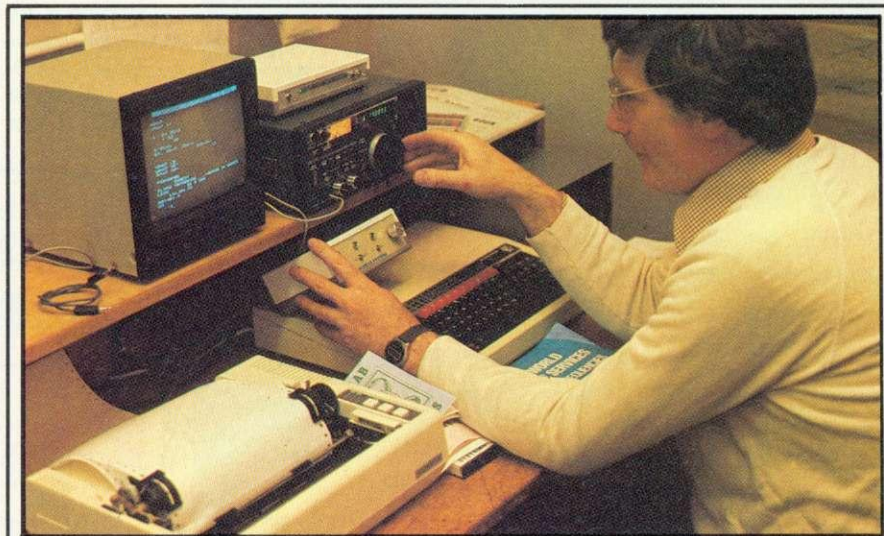

TURN ON, TUNE IN, PRINT OUT

Dan Ray takes time off from work in the television studio to pursue a hobby in RTTY. He is using a BBC micro and a short-wave radio to receive and decode radio teletype signals from the other side of the world. The teletype code is sent as two audio tones. These tones are fed from the earphone socket of the radio into a decoder that is connected to the user port of the micro. The decoder produces a digital signal that software running in the computer turns into text, which is displayed on the screen or printed out as hard copy on paper.

Get ready for the FIFTH great...

UMIST, Manchester.
Friday August 31 –
Sunday September 2

UMIST is where it all began – in June 1983 we held our first show, and it attracted 12,500 enthusiastic BBC Micro fans. The Renold Building at UMIST is ideally situated – only 5 minutes from the BR Piccadilly mainline station, and with plenty of parking space.

☆ All your problems will be answered at the “walk-in forum” being held throughout the weekend. Some of Britain’s top experts on the BBC Micro and Electron will be making guest appearances.

☆ Everything on display at the show will be for sale – often at special low show prices.

☆ Hundreds of new games, educational and business programs, plus all the latest hardware add-ons for the BBC Micro and Electron – for you to try out and buy!

EXHIBITORS INCLUDE

Acom Computers, Advanced Memory Systems, Aries Computers, Bucon, Cambridge Microprocessor Services, Clares Micro Supplies, Clwyd Technics, Computer Concepts, Com-soft, Cumana, Dynabyte Software, Enterprise Technology Computing, Feedback Instruments, Golem, HCR Electronic Sales, Holiday Brothers, Kansas City Systems, M.P. Software and Services, MRM Software, M.T. Direct, Mr Floppy, Manchester University Press, Micro Aid, Micro Aids, Micropower, Micro Simplex, Microware, Microvitec, NSC Computer Shops, National Micro Centres, News-soft, Opus Supplies, Pace Software Supplies, Specialised Education Software and Services, System, Universal Communications, Video Electronics, Viglen Computers, Wiseowl Publications, Wizard Developments.



Reduced prices for Groups

Entry only £1 per student if bookings are made in advance. Send your cheque (made payable to Database Publications) and SAE to:

Electron & BBC Micro User Show
68 Chester Road, Hazel Grove
Stockport SK7 5NY. Tel: 061-456 8383

Valid for a minimum of 10 people

SAVE MONEY with our Special Travel Offer

Visitors to the Show can obtain cut-price rail tickets from ANY station in the United Kingdom

For full details write to:

Travel Offer, P.O. Box 1, St. Albans AL1 4ED with SAE
or Telephone: St. Albans 34475 quoting: The Electron
& BBC Micro User Show.

*This voucher is worth
50p per head*



*By handing in this voucher
at the door you save 50p off
the normal admission
price of £2 (adults) and
£1.50 (children).*

(Valid for a maximum of 4 people)

10am - 6pm, Friday, 31 August
10am - 6pm, Saturday, 1 September
10am - 4pm, Sunday, 2 September

Renold Building, UMIST, Manchester.

Number attending: 1 2 3 4



Icom receiver and home-built decoder

indeed. It costs £52. There's a version for outdoors costing £70. Both include their own power supply.

Then comes the all-important link between the radio and the computer: the decoder. When you tune into an RTTY signal it is unmistakable—it really does sound like continuous chirping. This is because the signal is made up of two tones rapidly switching from one to the other. The lower tone represents the space, logic 0, and the higher the mark, logic 1. This is called Frequency Shift Keying (FSK). The difference between the two frequencies is usually quite small on the ordinary high-frequency (HF) short-wave band (that is, between 150 and 30,000 KHz). The two frequencies are 85 and 170 Hertz. On the FM band they are 30 and 220 Hertz. The decoder changes these two tones into zero volts and five volts respectively to represent the two logic levels of the code and feeds them into the user port of the micro.

Again, a glance through the radio magazines shows a number of small firms making decoders for most of the popular micros and they supply the necessary software to work with them. One system is made by Scarab Systems, whose decoder and software costs about £70. This can accommodate the two different RTTY frequencies for HF and FM short-wave trans-

missions. On the front panel are two light-emitting diodes (LEDs) labelled Mark and Space. These flicker on and off in rhythm with the signal, when it is tuned in properly. The LEDs are really important because as you turn the radio tuning knob the pitch of the signals varies quite dramatically and you have no way of knowing when it is right. Turn the knob until the lights start pulsing and then you know logic signals are being sent to the computer.

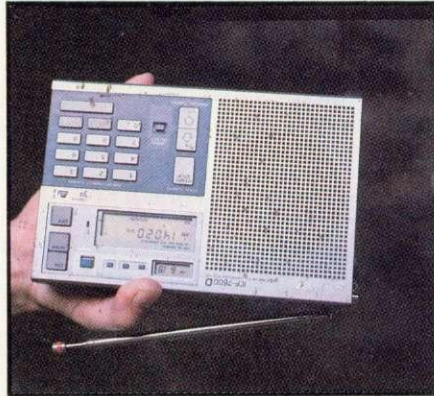

The Sony ICF-7600D is a full-facilities short-wave receiver costing about £160

In essence the software's job is quite straightforward. All it has to do is detect the start and stop bits of each word, refer to a look-up table to find out what character the five data bits represent and then print it on the screen. It has to do this quickly, of course.

Scarab's software is very nice. The documentation is clear and easy to use. It allows you to select a baud rate of 45, 75 or 100 and offers the facility for driving an Epson printer. When everything is tuned in and set properly words suddenly appear on the screen, a very exciting moment. If gobbledegook starts to appear try changing the baud rate before assuming you are receiving a coded message. With practice you will be able to tell what the baud rate is

by listening to the speed of chirping.

In fact Scarab's software does more than receive RTTY, it enables an amateur radio enthusiast to prepare and transmit messages as well, but you have to have a licence for radio transmission before you can do this.

You may experience interference problems from the computer itself, for the BBC micro transmits a lot of radio frequency signals. Make sure the aerial is as far away from the computer as possible. If this doesn't cure the problem you'll have to line the Beeb's case with aluminium foil and wrap all the external signal cables that come out of it in the same stuff. When the foil shield is connected to the ground it stops the interference signals from escaping.

The Scarab decoder is fine for 'standard' RTTY transmissions but one marketed by *Elektor* magazine in kit form gives provision for a much wider range of frequency shifts.

Sometimes you may not be able to resolve a signal into words at all. This could just be because it is being transmitted at a non-standard baud rate or frequency shift, or it could be that it is on one of the newer Teletype systems. There are two main contenders to the Baudot code: TOR and ASCII. The latter uses the same FSK transmission system but under the ASCII code. TOR (Telex Over Radio) is a bit more complicated. There are two types: ARQ and FEC. In both each data word has a checksum included so that the receiving equipment can tell if an error has crept into the transmission. ARQ stands for Auto Request, which means

CONTACT ADDRESSES

Icom IC-R70 communication receiver from:
Thanet Electronics, 143 Reculver Road, Herne Bay, Kent.

Sony ICF-7600D from:
Sony House, South Street, Staines, Middlesex TW18 4PF
or any good Hi-Fi shop.

Uniden CR-2021 communications receiver from:
Lecmar Electronics, Vectis Yard, Cowes, Isle of Wight.

Datong Active Receiving Antennas from:
Datong Electronics Ltd, Spence Mills, Mill Lane, Bramley, Leeds LS133HE.

MPTU-1 Tone encoder/decoder with software from:
Scarab Systems, 39 Stafford Street, Gillingham, Kent ME7 5EN.

RTTY computer interface from:
John Melvin, 2 Salters Court, Gosforth, Newcastle.

Elektor RTTY Decoder from:
Elektor Publishing Ltd, Elektor House, 10 Longport, Canterbury CT1 1PE.

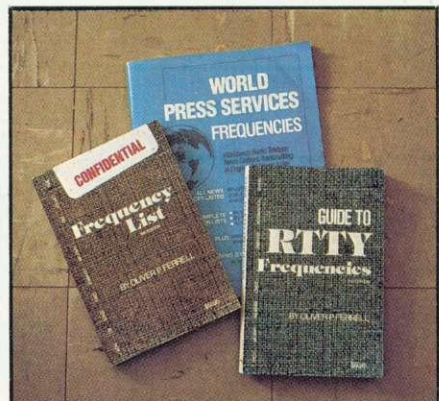

Figure 1. These books list the frequencies of most of the agencies in the world using RTTY

that if an error has been detected the receiving station transmits a signal to the sender asking for the last character to be transmitted. This is quite complex and requires the user to have a transmitter and a receiver.

FEC (Forward Error Correction) is simpler, it transmits everything twice and the receiver uses only the correct

The Definitive 24K ROM based Random Access Database Management System for the BBC Micro.

DATA

GEMINI



DataGem is here! The most comprehensive Database Management System ever written for the BBC Micro, allowing up to 5100 user definable records. Facilities are also included for interfacing with 'Wordwise' and 'View' word processors.

DataGem will not work with cassette based systems and requires a model B BBC Micro computer fitted with at least one disk drive and operating system 1.2 or greater. Use of a printer is optional.

Write to or telephone Gemini for further information, or complete the coupon below. Stock subject to availability.



Gemini

AU

18a Littleham Road, Exmouth, Devon EX8 2QG England

AVAILABLE FROM:

Larger branches of Boots and W.H. Smith and most good software dealers... or phone Gemini for immediate despatch quoting your Access, Visa or American Express card number. Telephone (0395) 265165/265832. Alternatively make your cheque or Postal Order payable to Gemini Marketing Ltd., and send to Gemini Marketing Ltd., 18a Littleham Road, Exmouth, Devon EX8 2QG.

Please send urgently..... DataGem(s) @ £129.95.
Prices stated include VAT and Post and Packing (UK only)

Name

Address

Signature

Credit Card No. Access/Visa/American Express

NOW AVAILABLE
FROM JOHN MENZIES
AND W.H. SMITH

A DOUBLE-SIDED 3" DISC DRIVE AT A SINGULAR PRICE.

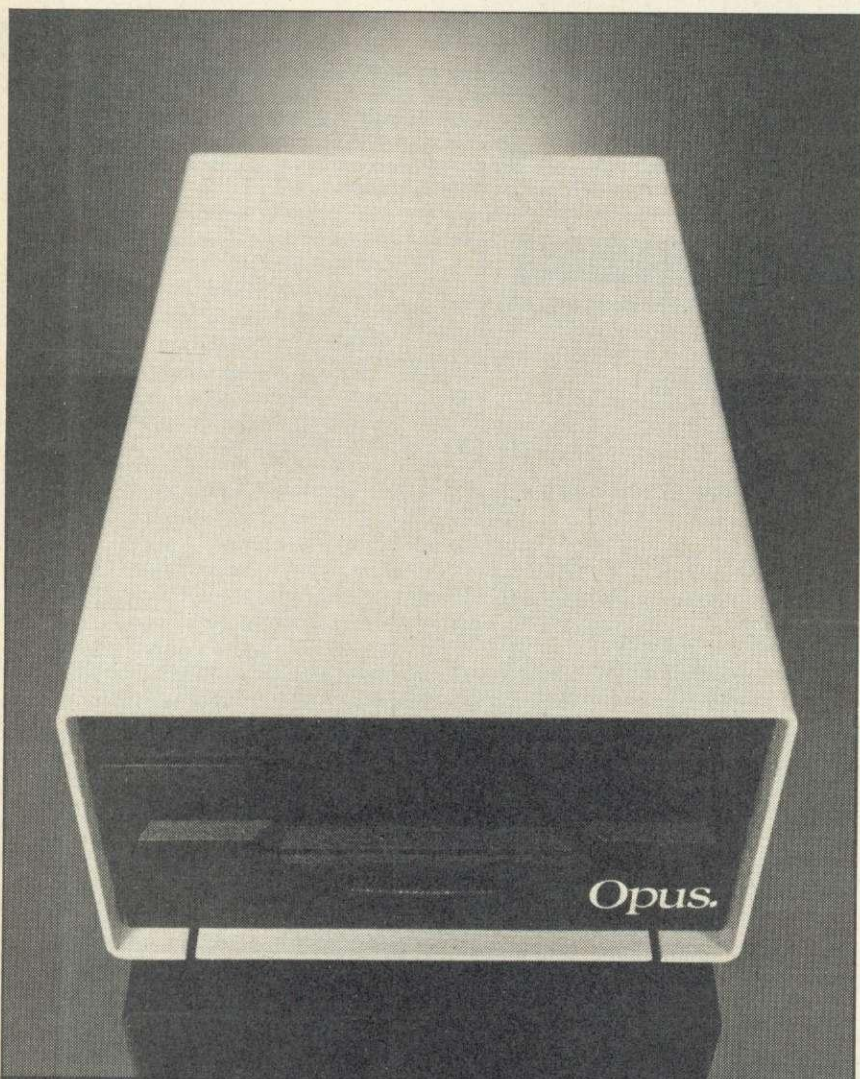

THE OPUS
SUPER 3 MICRODRIVE.

£229.95 (INC. VAT)

FOR USE WITH YOUR BBC MICRO.

For only £229.95 (and that includes VAT, and all the necessary leads) you can have an OPUS 500k double-sided disc drive. And remember 3" disc drives are fast becoming the standard for home and business use.

This is an even bigger bargain than it sounds. For you're getting a double sided drive at the price that other company's sell single sided drives for. It reads and writes to the disc cartridge from both sides, giving you twice the on-line capability of other 3" drives. And there's no need to flip the disc over!

STATE OF THE ART TECHNOLOGY FEATURING:

- Easy to connect to the BBC Micro
- Compatible with most other makes
- Comprehensive manual
- Free disc cartridge
- Format, verify and other utilities provided
- Direct Drive
- Double sided
- One touch cartridge load
- 3 ms access time
- Portable, compact and reliable
- Two years' full guarantee
- Totally compatible with 5¼" drives

TECHNICAL PERFORMANCE.

	Single Density	Double Density
Capacity	250K Bytes	500K Bytes
Recording density	4,915 BP1	9,830 BP1
Track density	100 TP1	100 TP1
Total number of tracks	40 (each side)	40 (each side)
Recording method	FM	MFM
Rotational speed	300 RPM	300 RPM
Transfer rate	125K Bits/Sec	250K Bits/Sec
Access time track to track	3 ms	3 ms
Access time settling	20 ms	20 ms
Motor start time	0.5 sec	0.5 sec

The Opus Super 3 Microdrive is now available from W.H. Smith, John Menzies and leading specialist shops. Dual disc drives are also available for £460.

OPUS SUPPLIES LTD.

158 Camberwell Road, London SE5 0EE.

Opening hours: 9.00-6.00 Monday-Friday,
9.00-1.30p.m. Saturday.



01-701 8668
01-703 6155

To: Opus Supplies Ltd., 158 Camberwell Road, London SE5 0EE. Please rush me the following: (ALL PRICES INCLUDE VAT & CARRIAGE.)

Quantity	Description	Price
	Single drive(s) at £229.95 ea.	
	Dual drive(s) at £459.95 ea.	
TOTAL		

I enclose a cheque for £ _____
Or please debit my credit card account with
the amount of £ _____

My Access/Barclaycard (please tick) No. is _____

Name _____

Address _____ AC27

Telephone _____

Opus.
Opus Supplies Ltd.



BUZZING WITH IDEAS

Tessie Revivis gives Electron and Beeb learners a flying start with an animation program that uses sound

ONCE the computer has been in your home for a few days and its keyboard mastered—or at least some confidence gained in using it—and the Welcome cassette worn out, the desire to produce your own program sets in. The programming task you set about will depend on your own inclination: you might like to incorporate the recipe book onto a tape, the secrets of the home brew or a pigeon-fancier's diary and your kids—well, Super Space Invaders Mark XI will suffice. Whatever target is chosen, all programs will, surprisingly, follow essentially the same general rules. In fact, almost every program you write will in verbal terms look a little like this:

Set all variables
Set up screen
Print information
Get information
Update items
If finished end
If not finished start again

As you can see from this list the rules are very general, but they provide a sound basis to expand from. The order might vary. For example, you might wish to set up the screen display before setting up variables or get information before printing any information to the screen, and so on.

If you have read through other pages in *Acorn User* (and I strongly suggest you do even if you don't fully understand—that will come in time) you'll have come across the term 'structured' programming, which simply means programming with a bit of thought or presenting your program neatly and logically. The list above, though very general, is an example of structured programming: simple, clear and logical.

Let's turn our hand now to writing a short program that uses a number of

the facilities available on the Electron. The program is simple, but provides easy animation and sound and can be stopped at any time just by hitting the space bar. The idea is that we get a fly to buzz to and fro across the top of the screen and when the space bar is pressed it crashes to the floor with a thud!

Before starting we need to think about our requirements. Most obviously we need the fly. To keep everything nice and simple we'll use the common or garden asterisk (*) to represent this. The easiest way to provide animation is to use the PRINT statement to put the asterisk on the screen, rub it out and then print it in the next location along the screen, thus providing the illusion of movement. To make this easier a special print positioning command is available in BBC Basic. This is the TAB (short for tabulation) command.

TAB treats the screen like a sheet of squared paper divided into rows and columns, the first column and first row being at the top left hand corner of the screen. In computer terms this is referred to as column 0, row 0 rather than column 1, row 1. Instead of using the long-winded column and row references these numbers are placed in brackets. For example, to print an asterisk at column 5, row 2 (figure 1 overleaf) we would use:

```
PRINT TAB(5,2) "*" "
```

To print a row of asterisks across the top of the screen the TAB routine can be placed inside a 'loop', which counts out the number of the columns. The actual number of the columns depends on the particular graphics screen chosen; we'll use the screen mode 0 as this is the biggest.

The short program to do this would be:

```
10 MODE 0
20 FOR column = 0 TO 79
30 PRINT TAB (column,3); "*" ";
40 NEXT loop
```

Here we have introduced a variable to keep count of the column, and to remind us of that fact I have called this variable column. The term variable implies its use, and it is really just a counter with a name. The count variable is used as one of the two values inside the TAB command. Each time the loop executes, column will have one added to it so that the PRINT command will TAB to the next column. The row count remains constant at 3 so that the asterisks are printed side-by-side across the screen.

The loop is controlled by line 20, 'FOR column = 0 TO 79', which causes the column variable to be incremented in steps of one from 0 up until 79. The incrementing process actually doesn't take place until the NEXT command is encountered in line 40, which makes the computer do all the instructions inside the command over again, providing of course the variable column has not reached the finish value of 79.

Rubbing out each asterisk is performed in a similar manner and within the same loop. All that needs to be done is to print a space over the old asterisk. Add the following lines:

```
32 FOR delay = 0 TO 50 : NEXT delay
34 PRINT TAB (column,3); " " ;
```

Line 32 is called a delay loop; it performs no practical function other than to create a slight delay to slow things down. Line 34 prints the space that blots out the asterisk. Note as in line 30 above the use of the two semi-colons after the TAB command. These simply ensure that the computer keeps printing on the same line. Try playing around with loop values to see the effect of different values (the best way to learn computing is to experiment!).

So far the fly just moves from left to right across the screen. To move from right to left, all we need do is get the printing loop to count down from 79 to 0.

A fly tends to buzz, so some experimentation with the SOUND command should provide the right sort of noise. I found that the command

```
SOUND 0, -15,2,1
```

had the right effect. To get a continual buzz try placing this in a suitable position in the FOR . . . NEXT loop.

page 35 ▶



SOFTWARE, FIRMWARE AND HARDWARE FOR YOUR BBC

Buy direct through Prestel (Page *2582020) using your Access card

Most programs available on Micronet 60043703

105 MAILING	Holds 218 addresses. Alpha & Post code sorts, searches, any label format, delete, add and amend	£11.95	B
201 GAMES 1	5 Card, Minefield, Darts, Pontoon & Mrmidon	£5.95	B/E
202 STOCKMARKET	Exciting world of Stocks and shares. 1-4 players	£5.95	B/E
301 HANGMAN	Word game in English, French, German, Italian, Spanish	£7.95	B
302 DISTANCES	Three graphic maps of U.K., EUROPE & the WORLD. Calculate the distance between any 2 places	£4.95	B/E
303 FLAGS	98 full colour flags of the world with questions	£4.95	B/E
304 STATPACK	Statistics package giving over 30 results	£9.95	B
305 GRAPH	Produce varied graphs & charts of functions	£7.95	B
306 FRENCH	A New audio visual computer way to learn a language	£7.95	B
307 SPELL-CHECK	Add to WORDWISE 15000 words in 12 dictionaries ideal in education	£17.95	B
504 PROCAID	includes SEARCHBAS to search a BASIC program and alter it. PROCVAR to list variables in a BASIC program & PROCFLUSH to clear resident integers in R M	£3.45	A/B
505 UTILITY-A	Our best selling tape includes PROCAID, DEFCHER to design & display graphic characters. SORTM/C a very fast machine code numeric sort. SORTBAS the undisputed fastest BASIC sort routine	£5.95	A/B
520 BANNER	Print giant text and graphics on paper for displays	£3.95	A/d
521 BIGLETR	Print as above on screen/paper with screen dump	£5.95	A/B
600 FORTH	'79 FORTH second language ROM	£34.74	B
601 LOGO-FORTH	Advanced Turtle Graphics Language ROM with FORTH	£57.50	B
602 PASCAL-T	Structured language ROM with compiler- interpreter	£57.50	R
603 XCAL	Computer Assisted Learning ROM for presentations	£65.00	B
605 WORDWISE	Super fast & easy to use wordprocessor in ROM	£33.95	B
606 CDUMP	Screen dump. 8 colours, suitable for GP700A	£12.95	B
607 GDUMP	Screen dump ROM. 8 shades. 8 sizes and windows	£17.95	B
608 GRAPHICS	NEW ROM for Sprites, LOGO, circles, etc	£27.50	B
700 BOOKS	Various titles for the BBC Micro from	£6.95	
801 CASSETTES	C15 Computer quality tapes packed in 10's	£4.50	
810 5.25" DISCS	MEMOREX: SS/SD 40/80T £19.95 SS/DD 40/80T	£20.95	
901 EPSON RX-80T/F	Superb. 100cps with Tractor & Friction feed	£275.00	
902 EPSON FX-80	Magnificent. 160cps. 6 founts, graphics, F/T Roll	£365.00	
910 DISC DRIVES	Slimline 3" or 5 1/4" 100K-800K Japanese. Format disc cable and excellent manual. Plus £50 of FREE Software	£189.00	
915 DISC UPGRADE	Double or Single Density available in one system	£89.00	
920 VDU STAND	Stainless Support protects your micro	£19.95	
930 GREEN VDU	12" Green Monitor. Cream sloping front case	£79.95	
931 COLOUR VDU	JVC 14" Colour Monitor 370 x 470 pixels	£179.95	

ADD VAT to ALL PRICES EXCEPT BOOKS

Add £1.75 for programs on 40 or 80 Track Disc. No post charge in UK Send for our free brochure for more information before parting with your money.

memo-calc

107 MEMO-CALC £12.95 B C/D
"IT MUST BE AMONG THE LEAST EXPENSIVE PIECES OF USEFUL SOFTWARE YOU WILL EVER BUY" Revue by Practical Computing July 1983.

Database/calcsheet program which allows up to 255 columns. The number of rows is automatically set from 5 to over 1000 depending on the columns declared. Both numeric and alphanumeric data can be stored in any cell and can be of any length up to 255 characters.

There are a multitude of uses for this program from accounts to diaries, club or personnel records etc. and is probably the one program that we all need. MODE7

107a Manual for MEMO-CALC included free otherwise £2.00 (0% VAT)

PAYROLL

Part 1 is a BASIC program running in MODE7 which accepts new data on employees, allows additions, deletions and alterations, listing of P35 & automatic alterations to the codes as required by tax notice P7X. Fully 'user friendly' with colour and graphics to make life simple for the operator.

Part 2 (WEEKLY) or Part 3 (MONTHLY) is designed to handle the calculations of wages and N.I. It allows for standard pay, two overtime rates, optional pension funds (monthly only) other pay, holiday pay, bonuses, post-tax adjustments and no pay.

106b COIN ANALYSIS £4.95 B C/D
106c PENSION £4.95 B C/D EXTRA
106d PAYSIP FORMS £20.34 per 1000 EXTRA

Buy direct or Prestel No. 25821534.

PRESTEL MODERN £78.00
PRINTER + VAT £120.00
IDEAL FOR FARM-LINK

Most Programs Now Available For MSX BASIC Dealer Enquiries Welcome

MICRO

ORGANISATION AT YOUR FINGERTIPS!

We are pleased to offer you a wide range of products primarily for the BBC microcomputer software, firmware and hardware for your computer system.

SEIKOSHA PRINTERS From £120-£369

A new range of printers (Spectrum Compatible) replacing existing models.



CASHBOOK

102 CASHBOOK £11.95 B C/D
FIRST CHOICE This is a double entry cashbook program showing cash and bank credits and debits. i.e. 4 columns. Any number of individual accounts can be used and analysed or totalled individually or cumulatively by associated group. A friendly but very practical, and reliable program which despite its low cost is used by many people in a range of situations from domestic and clubs to schools and businesses. MODE7

102d CASHBOOKd £19.95 B D
SECOND CHOICE This version of the above program uses random access disc files and can hold up to 1250 entries on 100K discs and up to 2500 on 200k discs. There is sophisticated protection against unauthorised use built in. MODE7

102f ACCOUNT £29.95 B D
THIRD CHOICE This version of the above program uses random access disc files and can hold up to 1100 entries on 100K discs, and up to 2250 on 200K discs. Included is a choice of CASH/BANK or VAT/BANK headings. Over 830000 possible accounts combinations. Ledger sheets and summaries can be printed as well as full accounts. The latest balance is available at any time. This program is only available on disc. MODE7

Programs of the Month

BUDGET £9.95 + VAT

BUDGET can be used by anybody in a domestic environment to help them with their own budget, by clubs charities wishing to prepare applications for grants and for submission to committees, by educationalists in classrooms to show students where money comes from and how easily it disappears. Available on cassette for the ELECTRON and cassette or disc for the BBC Micro using any operating system.

CRIBBAGE £7.95 + VAT

Cribbage is played with a full pack of 52 cards. An ace always counts as '1'; a Jack, Queen or King counts as '10' when its value is added to others but ranks in normal sequence when scoring runs. There are usually two players, and the most common forms of the game are the five-card and six-card. The winner of the game is the first to score 61 or 121 respectively.

Stop Press

RANDOM MAILING up to 1850 addresses, names, phone numbers & codes one disc. Selective printing any number of labels, repeat, stationery or fan fold. Automatic WORDWISE & letters produced repeatedly with personalised names many other features such as automatic sorting by company or personal names. By far the best and most comprehensive program of its type for the BBC Micro Price £29.95 + VAT

Micro-Aid

25 Fore St. Praze, Camborne Cornwall. TR14 0JX tel: 0209 831274

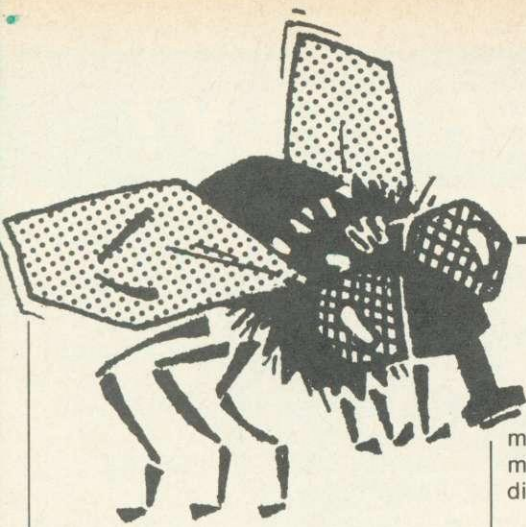

◀ page 33

Our original idea was to kill the fly once the space bar was pressed. To do this we need to incorporate a keyboard test or scanning routine. Two lines are needed for this as follows:

```
36 key$ = INKEY$(0)
37 IF key$ = " " THEN END
```

Line 36 introduces a new type of variable, a string variable. String variables of this kind are used to hold a character (a keyboard character in this case) as opposed to a number. The INKEY\$(0) command tells the computer to look at the keyboard very quickly, and if a key is pressed place its value in the variable key\$. The next line, line 37, tests to see IF key\$ equals a space THEN END. If keystring (key\$) doesn't contain a space the loop will continue.

At the start of the article I laid out a general program instruction list and talked about structured programming. Much of what we have played around with so far hasn't been particularly well structured, but before writing the main program it is often useful either to think your ideas through or experiment at the keyboard in this manner. Let's now map out the Fly in the Sky program in a logical manner. Writing it down on paper we might end up with:

1. Set up MODE 0 screen
2. Set up move fly left to right loop
3. Do fly moving procedure
4. Set up move fly right to left loop
5. Do fly moving procedure
6. Repeat items 2, 3, 4 and 5 until fly is dead

Now we have the main program, albeit

in words, needed to perform the task in hand. Or do we? There's no provision for the sound or key testing we have discussed. In fact, these items are minor and are considered as subsections of the main program. Consider item 2, the fly-moving procedure. This could be subdivided as follows:

- a. Print fly
- b. If space key tested then do die procedure
- c. Make buzz sound
- d. Do a delay loop
- e. Rub out fly
- f. Do items a,b,c,d, and e until complete

This list of items compares to the short lines of program we developed above. BBC Basic is unique in that groups of statements can be enclosed inside a special program casing called a procedure that can be given a name and placed outside the main program. A typical program containing a procedure might go like this:

```
10 PROCdemo
20 END
30:
40 DEF PROCdemo
50 PRINT "This is a demo"
60 ENDPROC
```

Enter this and run it. As you can see, the procedure is called PROC in Basic and is also given its own unique name, thus the command PROCdemo will cause the commands inside the procedure PROCdemo to be executed. The procedure itself is prefixed by a special command DEF, which is shorthand for define.

The procedure must also be terminated by another new command, ENDPROC (end procedure).

We need to incorporate another procedure in the program that will be executed if the space bar is detected being pressed. PROCdie might be written like this:

- a. rub out old fly
- b. do a dying fly sound
- c. print fly one line down
- d. do a delay
- e. rub out old fly
- f. do b,c,d and e until fly hits the floor
- g. do fly hitting floor sound
- h. end fly die procedure

Now we have a main program and two procedures. We know exactly what our program needs to do and how it performs it without so much as writing a single Basic command, apart from a bit of early experimentation. Get into the habit of doing things this way; it may seem long-winded at first, but I can assure you virtually all professional programmers write their programs in this way. Sitting down directly at the computer and writing Basic off the top of your head leads to a bad program-



ming technique and it is frustrating when the program doesn't work correctly (as I've proved many times).

Finally, the program (listing 1). Look carefully at it, trying to pick out the structure within it and how the commands relate to the list we constructed earlier. You might not recognise several of the commands so get your *User Guide* out and find out exactly what they do. If you are still not sure try experimenting with them to see the effects that different values have. Programming is all about practice and experimentation.

The 'Fly in the Sky' demonstration program (listing 1) appears on yellow page iii

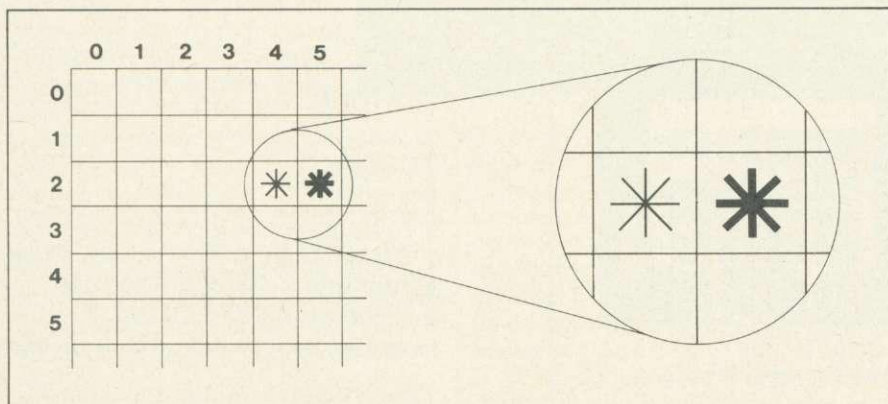

Figure 1. The fly (represented by an asterisk) is 'moved' across the screen by being printed and then rubbed out in each column consecutively



DO YOUR INVADERS FLY?

OR DON'T THEY EVEN GET OFF THE GROUND?

Bring your designs
to life with

SIMONSOFT SPRITES VERSION TWO

FOR THE BBC 32K + ELECTRON

SAVE £4
NOW ONLY £8.95
WHILE STOCKS LAST

Transfer your ideas for multi-coloured characters directly to the computer and screen with the easy to use grid-based generator program. As you design the sprites they are automatically stored in our sprite routine which lies hidden under your program. The machine code sprite routine will move the shapes at incredible speeds of fourteen (14) times that of ordinary basic – and the routine is controlled with simple commands from your own Basic program!

Simonsoft sprites are used in programs on the market now. We claim no royalties on programs using our sprite routines.



OG THE CAVEMAN at £7.95 BBC 32K + ELECTRON (£9.95 disc version).

Og is in a calamity. His territory has been taken over by dinosaurs that lay eggs at a really hectic rate. Og must crush the brood before they hatch by jumping on to each and every egg. Og's problems are compounded by a pack of slavering dinosaurs hungry for his blood – and on higher levels by grand old Ma dinosaur herself. Og can use his magic staff to set a trap, but time is precious as Og knows all too well. Big bonuses can be scored for jumping on fruit, and an even bigger bonus for snatching a kiss from his waiting cavewife.

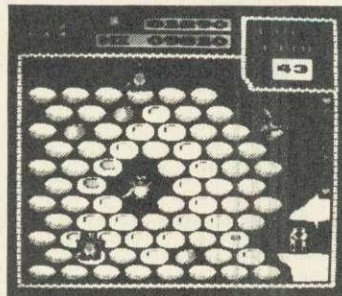

SCREEN PHOTOGRAPH

SUPERFRUIT at £5.95 for the BBC 32K + ELECTRON (£7.95 disc version).

Features full colour hi-res graphics, great sound effects, spinning reels, 5 x 4 display of fruit, "bounce" as each reel settles, nudge box, nudge gambles, two-way nudges, swap reels, hold reels, collect win, gamble any win, "loser's gamble" if first gamble is lost, Supergamble for the jackpot and a coin pile that shrinks and grows with your winnings. Separate instruction program. This implementation is in a class of its own.

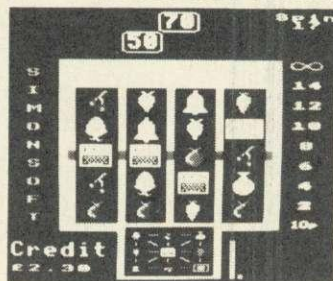

SCREEN PHOTOGRAPH

A MUST for anyone who wants to see their BBC's graphics stretched to the very limit.

FEATURES:

- An ASTOUNDING FOURTEEN (14) FOLD INCREASE over the speed of ordinary Basic
- GENERATOR PROGRAMS with which you design MULTI-COLOURED SPRITE CHARACTERS
- SUPERSPRITES of up to 24 x 24 pixels
- 48 SPRITES made up of 12 separate designs each with 3 clones
- INSTANT ANIMATION with two images per sprite that switch automatically
- ENLARGEMENT FACILITY OF x2, x3, x4, x5 sprite size
- BUILT IN COLLISION DETECTOR
- FLIGHT PATHS that sprites can follow automatically
- SPRITE LIBRARY of ready to use character designs
- 30 PROGRAMS – choose the routine with the features best suited to your own program. Hidden under your Basic program the routine need take as little as 1.5K memory.
- SAVE/LOAD your program and sprites AS A WHOLE
- COMPREHENSIVE COLOUR MANUAL
- INTRODUCTION PROGRAM and DEMONSTRATION GAMES

Available at: £8.95 cassette, £8.95 cassette for transferral, £11.95 40/80 track disc to disc.

RETURN POST DELIVERY

Please rush one _____

_____ at £ _____

for the _____ computer.

Name _____

Address _____

Cut out this coupon and send it to:
**SIMONSOFT, 25 Tatham Road,
Abingdon, Oxon OX14 1QB
Telephone 0235 24140**

PROGRAMMERS: We pay lump sums and/or royalties of up to 30% for EXCELLENT PROGRAMS.

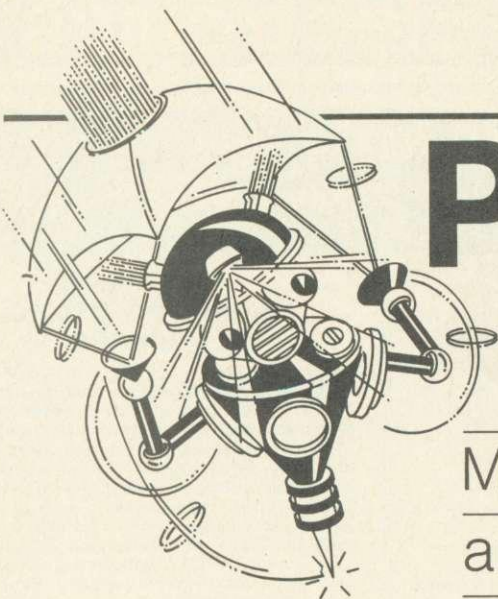

PARANOIDS DROP IN

Michael Why's zappy game is also
an easy way to learn procedures

37

THE idea for *Paranoids* came to me while I was watching a horror film. I wanted to give the user a non-stop game in which he would have to have his wits about him all the time so as not to lose interest.

The game starts off with three Paranoids (Paras for short) coming down from the top of the screen and you have to shoot them with your laser-powered tank before you pass on to the next level. On this level four Paras descend and when you've shot them, five – and so on. If a Para lands before you can shoot him you will lose a life, and the game is over when you lose three lives, and your final score will be displayed.

The game is played on just three keys. Left and right movement of the tank is controlled by the Z and X keys respectively. The tank's laser cannon is fired by the space bar.

The game was written on an Electron but it is compatible with the Beeb. I started the project by drawing up a flow-chart (figure 1). This is an essential part of designing a program, as it sets out the whole structure. My next step was to construct a variables table (figure 2). As you can see, all the names mean something to the programmer and are built up in such a way as to remind him what he is doing – thus cutting down on debugging the program.

Next I wrote down the program on coding paper, which is divided into rows and columns, one character per block. The point here is that it helps speed the completion of the program. In fact I wrote down only the main part of the program, for if the main structure doesn't work there is not much point in adding instructions, sound and colour etc.

This is how the program is structured, with a breakdown of the procedures:

PROCINIT defines characters, variables and also turns off the text cursor. This procedure also defines whether the Para will come straight down, from the left or from the right. It also sets up **PARA\$(1)**, **PARA\$(2)** etc. depending upon how many Paras are to come down.

PROCTANK checks to see if the HOLD key has been pressed. If it has then it sets up a simple REPEAT . . . UNTIL loop. When the X key is pressed it ceases to continue. This procedure also checks if the left or right key has been pressed; if either has then it is acted upon and produces a sound.

PROCPARAS is the most important procedure in that, as the name suggests, it moves the Paras and checks if

and the Para turns up on the right-hand side. Each time through the loop in **PROCPARAS** the flow of the program branches to **PROCFIRE**, a procedure which checks to see if the space bar has been pressed. If it has not it returns to **PROCPARAS**. If it has a sound is produced and the laser is drawn. If while shooting, the **PARAX%** position is the same as the **FIREX%** position the laser must have hit the Para so **PROXPLODE** is called up. This then prints an explosion over the Para, a delay occurs and a space is printed over the Para and a sound produced. Line 850 is the most important line as the increment that is used to make the Para move is then made equal to zero, also **PARAX%** and **PARAY%** are then made equal to 3 and 2 respectively. This means that the Para is stored as TAB (3,2). At this point the laser from the tank is unable to reach across this far, so giving the impression that the Para is no longer there.

PROCLEVEL increases the loop in **PROCPARAS** so that if five Paras came down previously then six will now come down.

PROCNEW-LIFE comes into action when a Para lands (which is checked in **PROCPARAS**). If **LIVES% = 3** then three lives have been lost and your game is over. If **LIFE% = 1** it goes to **PROC-**

TANK-LOST.

PROCTANK-LOST prints out "LIFE LOST" with a short beep and delay between each letter.

PROCGAME-LOST prints up your final score and asks if you would like another go.

Now that I've described the procedures I can give you advice on how to achieve better scores. Before you

page 45 ▶

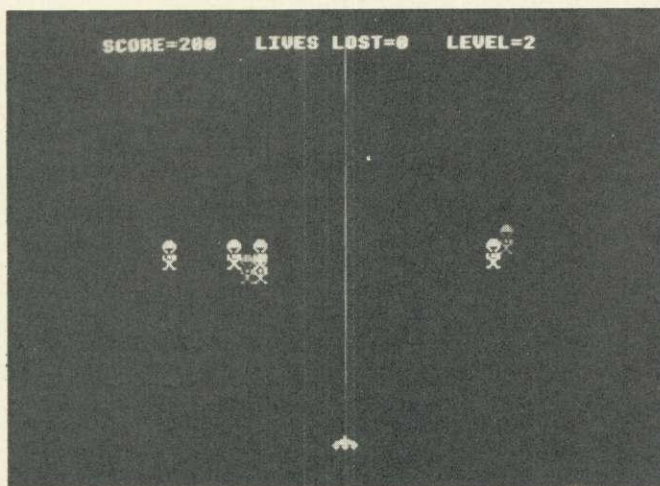

they have landed or reached either side of the screen. In the procedure is a loop which moves **PARA\$(1)**, **PARA\$(2)** etc (depending on the size of the loop) one position. The Paras can only move between columns 3 and 35 of the screen; if they move outside these limits they reappear on the other side of the screen. So if a Para reaches column 35, its X position is made equal to 3 and it reappears on the left-hand side. Similarly, if the Para tries to move into column 2 its X position is changed to 35





Watford Electronics

Dept. BBC, CARDIFF ROAD, WATFORD, HERTS. ENGLAND.

Tel: Watford (0923) 40588/37774 Telex: 8956095 WAELEC

ACCESS ORDERS Tel: (0923) 50234



SPECIAL OFFER

BBC Micro (Model B) New Low Price £346

Price includes a **FREE** Data Recorder PLUS five software programs worth £80. (At Watford we give you a great deal for your money)

6502 2nd PROCESSOR **£175**
Z80 2nd PROCESSOR **£262**

Dust Cover for BBC Micro

Protects your expensive Micro from foreign bodies. **£3.50**

SEIKOSHA GP100A PRINTER

10" Tractor Feed, 80 columns, 50CPS. Normal & Double width Char, Dot res graphics. Parallel Interface standard. SPECIAL OFFER Only: **£144** £7 carr.)

FRICTION FEED

Attachment for GP100A or 250X Printers **£28**

GP-700 Colour Printer Screen-dump routine in ROM FOR BBC Micro **£12**

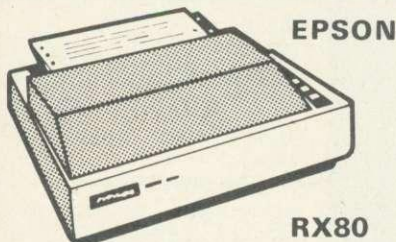

100 CPS, 9 x 9 matrix, dot addressable graphics, condensed and double width printing. Normal, Italic and Elite Graphics. Tractor feed, 10" max width, bi-directional, logic seeking. Centronics Interface standard.

ONLY **£229** (£7 carr.)

EPSON RX80 F/T PRINTER

As above but has both Friction and Tractor Feed. **£245.00** (£7 carr. Securicor)

PRINTER INTERFACE BUFFER

Neatly packaged self contained box, supplied complete with all leads, manual and detachable power supply.

Price: 16K Unit **£115**
Price: 48K Unit **£149**

Epson FX80 Printer

160 CPS, 11 x 9 matrix, proportional spacing, superscripts, subscripts, dot addressable graphics. Normal, Italic and Elite characters. Up to 256 user definable characters. Down loadable character set. Condensed and double width printing. Full proportional spacing. Four user defined margin positions. Tractor and Friction feed. 10" maximum width Bi-directional, logic seeking Centronics interface standard.

ONLY **£319** (£7 carr.)

Type	Ribbons	Dust Covers
MX80FT	£4.75	£4.50
MX100/FX100	£10.00	£5.25
FX80	£4.75	£4.95
RX80	£4.75	£4.50
GP80	£4.50	-
GP100	£4.95	£3.95
GP250	£5.95	£3.95
GP700	£18.50	
KAGA KP810	£5.95	
CANON PW1080	£5.95	

RX & FX PRINTER INTERFACES

RS232 **£35** RS232 + 2K Buffer **£59**
IEEE 488 **£65** 2K Parallel **£58**

BROTHER HR-15 DAISY-WHEEL PRINTER

An exceptionally high quality daisy wheel printer at the price of a dot matrix printer. 18CPS; bi-directional, 3K of buffer; has clear buffer facility, carriage skip movement, proportional spacing; underlining; bold print and shadow print. Prints in two colours; super and subscript facility. Impact control facility to vary pressure on paper for making carbon copies. Has Centronics parallel or RS-232 interface. Connects directly to BBC Micro. A ribbon cassette plus a separate red ribbon. Optional extras: single sheet feeder takes up to 150 A4 sheets; a keyboard that transforms HR15 into a sophisticated electronics typewriter. Attractively finished in beige.

ONLY **£349**

Single Sheet Feeder **£199**
Keyboard **£150**
RIBBONS: Carbon **£3**; Fabric **£3**;
Multistrike **£6**

LISTING PAPER (Plain)

1,000 Sheets 9½" Fanfold Paper **£7**
2,000 Sheets 9½" Fanfold Paper **£13**
1,000 Sheets 15" Fanfold Paper **£9**
Teletypewriter Roll (Econo paper) **£4**

PRINTER LABELS

(continuous stationery)

1,000 90 x 36mm **£5.50**
1,000 90 x 49mm **£7.75**
1,000 102 x 36mm **£6.25**

Carriage on Printer Paper or Labels **£1.50**

BBC Micro WORD-PROCESSING PACKAGE

A complete word processing package consisting of: BBC Model B, Zenith 12" Green or Amber Monitor, Twin 200K highly reliable (1 year warranty) Cumana Disc Drives in matching beige colour, the popular WORDWISE word processor, Watford's own highly sophisticated 62 File DFS interface fitted, world renowned Brother HR 15 Daisy Wheel Printer, Gemini's BEEBCALC Spreadsheet Analysis, MAILING LIST and DATABASE Softwares on Disc. 10 blank 3M Discs (Lifetime warranty). A 4 way mains distribution socket. 10 blank diskettes, 500 sheets of fan-fold paper. Manuals and all the leads. To enable you to carry your Micro around, we shall pack it in our Antique Brown leatherette Attache carrying case.

ONLY **£1,199** (carr. £15)

(P.S. We will alter the package to suit your requirement. Call in for a demonstration).

KAGA KP810

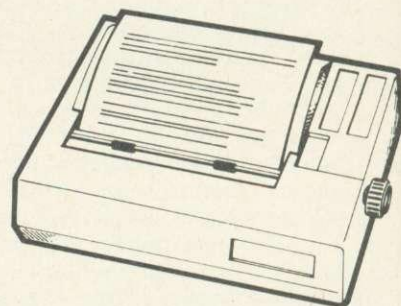

This new JAPANESE printer has EPSON FX/RX compatible commands. 140 CPS Dot matrix Printer, offers **NEAR LETTER QUALITY** print in a 23 x 16 dot matrix in addition to the standard Epson style type-faces on the 11x 9 matrix. Friction feed, Adjustable tractor feed, Single sheet feed and built-in Paper Roll Holder. Normal, Italic, Enlarged, Condensed, Super and Subscript. Dot addressable graphics (8, 9 and 16 pin modes). Proportional spacing. (Optional extra: Down loadable character set in 8K ROM or RAM). NEAR LETTER QUALITY print, selectable at switch on. 10" maximum width, bi-directional, logic seeking. 3K Buffer. Half speed quiet mode. Convenient Paper-out sensor switch. Centronics Interface standard. All this plus our no quibble 12 months warranty.

Special Introductory Offer: ONLY **£249**
RS232 Interface + 2K Buffer **£89**

KAGA KP910 PRINTER

Similar features as the above KP810 printer but has extra wide carriage. Will accept upto 17" maximum width paper. 156 column normal and 265 column condensed.

ONLY: **£349**

PRINTER LEAD 36"

Ready made printer lead to interface BBC Micro to EPSON, SEIKOSHA, NEC, STAR, JUKI, BROTHER, SHINWA, CANNON, KAGA, or any Centronics Parallel Printer.

ONLY **£7**

Special Extra long 5 feet Cable **£10**

EPROM PROGRAMMER

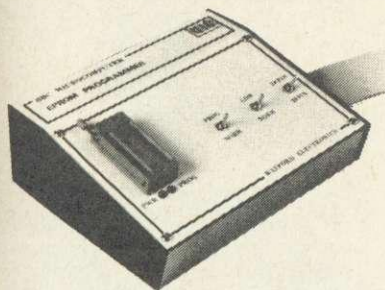

At last! - the EPROM Programmer for BBC Micro Computer from WATFORD ELECTRONICS

that will suit both your pocket and all your requirements. Programs all popular types of EPROMS from 2K bytes up to 16K bytes - 2716 - 2516 - 2532 - 2564 - 2764 - 27128. Our Programmer has been designed to make sure the EPROMs are neither programmed too fast nor too slow; just at the right speed as recommended by the manufacturers of the EPROMs (any deviation in timings can burn their brains out).

This extremely powerful system is designed for your needs of TODAY & TOMORROW! - BBC Basic programs can be copied into EPROM and subsequently re-loaded faster than from a disc! Suitable for both hobbyist and professional users!

Just look at these features:

- **COMPLETELY SELF CONTAINED** - Housed in its own sturdy case - Uses its own power supply - connects directly to the 1MHz Bus - Simple and Safe!

- **FULL SOFTWARE SUPPORT** - Comes complete with simple to use fully machine code ROM based software and easy to understand manual. Facilities include Verification, Reading, Virgin Testing, Writing, Editing, Saving, Loading and more! NOTE!! - This software does not simply comprise hastily prepared routines to get you going, but is a professional, purpose designed applications package.

- **ACORN BUS COMPATIBLE** - Use of the 1MHz connection complies with all Acorn addressing recommendations - That means you can still add-on such things as the TELETEXT, IEEE 488 TUBE and PRESTEL

- Allows more than one program to reside in an EPROM using the ROM Filing System.

ONLY £79 incl. Manual (£3 carr.)

TEX EPROM ERASERS

EPROMs need careful treatment to survive their expected lifetime. Rushing it could burn their brains out. So cop-out of this helter-skelter world; take it easy the TEX way and give your chips a well earned break. Cool, gentle and affordable. EPROMPT does it properly.

Two versions available:

- **EPROMPT EB** - The standard version. Erases up to 16 chips. £28.00

- **EPROMPT GT** - Erases up to 28 chips. Has an incorporated safety switch which automatically switches off the UV lamp when the Eraser is opened. £30.00
Spare 'UV' Lamp bulbs. £9

NEW DESIGN PLASTIC LIBRARY CASES

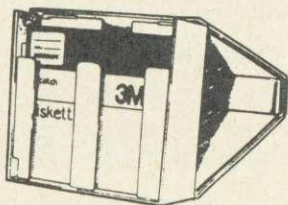

for Disc Storage 5 1/4" (holds 10) £2

MONITORS

- **MICROVITEC 1431**
14" Colour Monitor, RGB Input. (as used in BBC programmes) FREE Interface Lead. **ONLY £173**

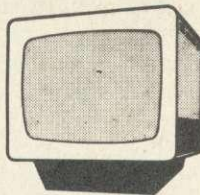

- **MICROVITEC 1451**
Hi-res 14" Monitor incl. lead **£295**
- **MICROVITEC 1441** Super Hi-res
14" Colour Monitor **£249**
- **KAGA 12"** Standard resolution colour
MONITOR/COMPOSITE VIDEO **ONLY £195**
- **KAGA RGB 12"** Medium
Resolution Colour **£195**
- **KAGA RGB 12"** High Resolution Colour **£259**
- **BNC** Connecting Lead **£3**
- **RGB** Connecting Lead **£5**
- **ZENITH 12"** High resolution, jitter free
picture, Amber or Green **£75**

Carriage on Monitors £7 (Securicor)

5 1/4" DISKETTES

(Lifetime warranty)

Why settle for less, Buy the best.

- 10 SCOTCH 3M Diskettes S/S S/D **£15**
- 10 SCOTCH 3M Diskettes S/S D/D **£17**
- 10 SCOTCH 3M Diskettes D/S D/D **£28**

DISC ALBUMS

Attractively finished in beige leatherlook vinyl. Stores, protects and displays 20 discs in double-sided clear view pockets. **ONLY £4.25**

LOCKABLE STORAGE UNITS

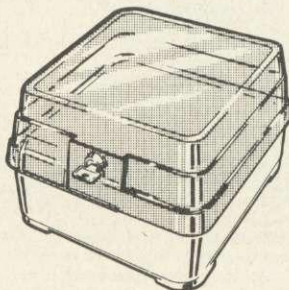

Attractively finished, strong beige plastic base fitted with dividers. Smoke acrylic top. Supplied with adhesive title strips for ease of filing.

- M-35 Holds upto 35 mini discs **£13**
- M-85 Holds upto 85 mini discs **£18**

FLOPPY HEAD CLEANER KIT

Unless your Office/Home is dust free, you should clean floppy-heads at least once a week to avoid the risk of cross contamination. Very simple to use. **Only £14**

MONITOR CRT SCREEN CLEANING KIT

The anti-static spray controls dangerous static charges on the screen surface and ensures its optical clarity. **£12**

KEYBOARD CLEANING KIT

£16

PRINTED CIRCUIT BOARD CLEANING & LUBRICATION KIT

£14

DISC DRIVES CASED WITH CABLES (less PSU)

(All Drives are NEW SLIM-LINE Type)

NEW LOW PRICES

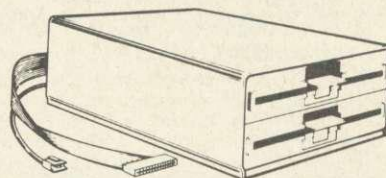

- **CLS 100** Single, TEC Single sided 40 track
100K, 5 1/4" Disc Drive **£115**
- **CLS400** Single, Mitsubishi Double sided 80
track 400K, 5 1/4" Disc Drive **£165**
- **CLS400S** Single, Mitsubishi Double sided
40/80 track Switchable, 400K, 5 1/4" Disc Drive **£199**
- **CLD200** TEC Single sided 40 track 200K,
twin 5 1/4" Drives **£225**
- **CLD800** Mitsubishi Double sided 80 track
800K, 5 1/4" TWIN Drives **£325**
- **CLD800S** Mitsubishi Double sided 40/80
track switchable, 800K, Drives **£249**

(CUMANA) DRIVES CASED

WITH PSU & CABLES

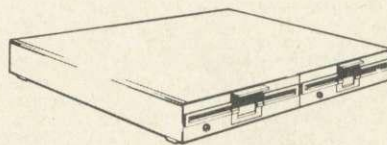
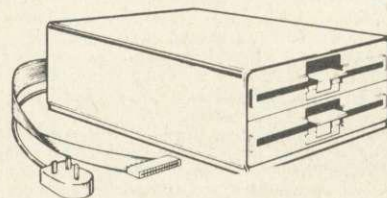

- **CS100** TEC Single sided 40 track 100K 5 1/4"
Single Disc Drive **£139**
- **CS200** TEC Single sided 80 track 200K 5 1/4"
Single Disc Drive **£205**
- **CS400** Mitsubishi Double sided 80 track
400K 5 1/4" Single Drive **£225**
- **CD200** TEC Single sided 40 track 200K 5 1/4"
TWIN Disc Drives **£245**
- **CD400** TEC Single sided 80 track 200K 5 1/4"
TWIN Disc Drives **£365**
- **CD800** Mitsubishi Double sided 80 track
800K 5 1/4" TWIN Drives **£425**
- **CD800S** Mitsubishi Double sided 40/80 track
Switchable 800K TWIN Drives **£465**
- **SPARE DRIVE CABLES, SINGLE £6; DUAL £8**
- **DFS Manual (comprehensive) £7.50 (No VAT)**

P.S.

1. You do not require Formatting Discs when using our DFS as the formatting program is in the ROM, nor do you require expensive 40/80 track switchable drives as with our DFS you can read and write both 40 and 80 track discs in an 80 track drive (software switchable).

2. Our **MITSUBISHI** Slimline Disc Drives are Double Sided, Double Density, 1 Megabyte. Track density 96 TPI, track to track access time 3mSec. They are fast, efficient and highly reliable.

Continued

WONDERFUL WATFORD

TWO DATABASE SOFTWARE for BBC MICRO

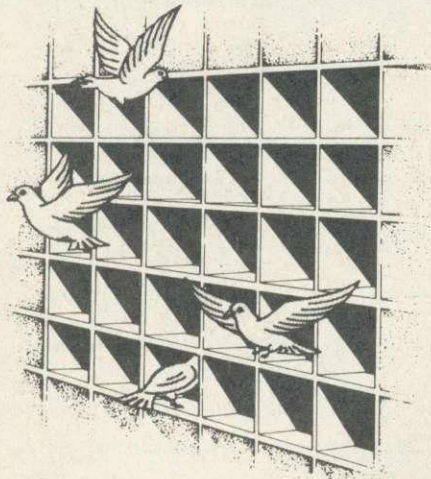

DISCDATA

At last for BBC Micro Disc users, Watford Electronics have produced 'DISCDATA' which must be the most versatile general database at the price on the market. The length of your files is restricted only by the space on your disc. You can have upto 20 fields with 'page' length records of upto 254 characters. The program is completely menu driven obviating reference to a manual although written guidance is given with the program. Add and delete records, amend title, field names and records, sort on any field and search for any record or group of records in any field. You do not need to abandon or rewrite your files if you wish to add additional fields or extend the length of any field, the program will rewrite the files for you. Your files can be in any drive. Output can be in 40, 80 or 132 character width with Printer routines. Two forms of output are provided for horizontal for label type output and a tabulated output with title and headings. What is more, the selected fields can be placed in any order on the screen. In the horizontal mode you can scan backwards or forwards with wrap around effect. Output can be started or stopped anywhere in the file. There is automatic totalling on decimal fields and an automatic count of the number of records output. Now with extra 3 features: Allows string search; Calculations can be done on numeric fields; Create Sub-Files from the main File.

On disc at **Only £17**
It has to be the best value.

FILE-PLUS

Now even more powerful with the added facility of a SHELL SORT on any field. This must make DATA-PLUS the most powerful and versatile Database to be found on BBC Micro.

A 16K ROM containing the most flexible and easy to use disk based Database system on the market. A database may occupy your total on-line storage capacity. You may design any number of data entry forms using a "paint" on screen technique. Forms may be upto 3 screens in size. A form may be used to Add, Delete, Update, Print and Spool records from your Database. Quick search facility on any text field. A query language provides full maths support (-, +, /, *, +-9999999999.9999) and compare facilities (=, >, <>, <=, >=, &, !) when used with the keywords - Assign, Compare, Display, End, Goto, If, Ift, Print, Read, Search, Spool and Update. Full printed output control via embedded commands. Supplied with 70 page manual and fitting instructions.

Only £43

BUFFER & BACKUP ROM

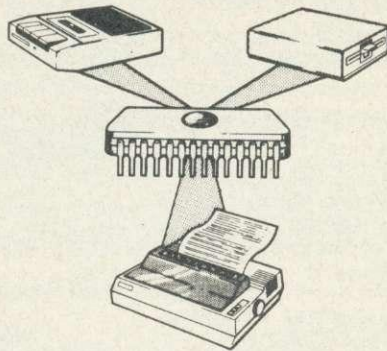

A very versatile firmware. An ideal ROM for engineers, programmers, teachers, students, etc.

★ Converts your Sideways RAM to a 4K or 16K BUFFER for a parallel printer. (Uses * FX5,3). (You no longer require to purchase expensive (£100+) Printer Buffers.)

- ★ Dumps selection of Disc files to Tape.
- ★ Makes backup copies of tapes onto Tape, Disc and Hobbit.
- ★ Displays contents of a chosen paged ROM on screen.
- ★ Menu display on 'shift-break' using ROM Filing System.
- ★ Comprehensive Manual

Simply a give away at

£22

GEMINI'S BUSINESS SOFTWARE

Cashbook Accounts	£52
Final Accounts	£52
Invoices & Statements	£17.25
Commercial Accounts	£17.25
Mailing List	£17.25
Database	£17.25
Stock Control	£17.25
Home Accounts	£17.25
Beebcalc Spreadsheet Analysis	£17.25
Beebplot	£17.25
Payroll	£39

N.B. All the above Gemini software is on tape. For Disc Based (40/80 track) please add £3.

PEN PAL - VERSATILE LIGHT PEN SOFTWARE

- Enjoy, Explore, Educate!
- Pixel, Line, Character Definition
- Free hand drawing
- All Colours - MANY Special Effects
- Fill, Refill and Stripes
- User defined "Brushed Strokes" plus Character definer
- Grid, Scale, Perspective aids
- 2 TO 200 Points palletable in one Design with Circles and "RUBBER BANDING"
- Move design/character to any screen position
- Save and Load screens, User defined Graphics and line drawings for video titles, Own programmes, etc.
- Many Educational uses
- Instruction booklet included
- Full software support for "CUSTOM USE"
- Works with Watford, RH, Acorn User, DIY, and many other LIGHT PENS
- Available on DISC or TAPE

Price: Tape £10; Disc £11

DISC EXECUTOR

Disc Executor (our most popular software) is a highly sophisticated disc utility, which allows you to transfer all tape based software that we know of onto disc. You no longer have to throw away any of your cassette based software on acquiring a disc drive. It handles 'locked' programs and allows you to load full length adventure type programs (i.e. up to 6E blocks) and programs that load below &E00. It is very simple to operate (full instructions supplied). It saves you your valuable time and money too. Our Disc executor is not a Replica, its the 'Real Thing'. Available in both 40 and 80 track discs. Please specify when ordering.

Only £10

ROM MANAGER

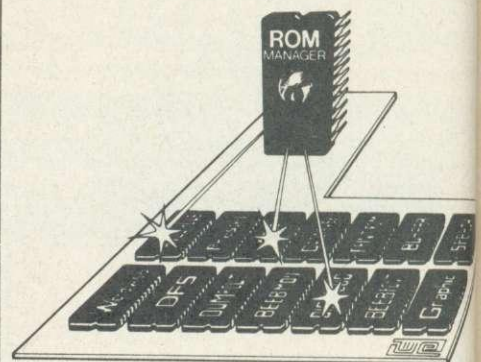

This unique piece of firmware has been designed to allow the USER to access the BBC Micro's Sideways Rom Paging facility to the full. The 18 Commands our ROM MANAGER adds to your computer are concerned with 3 aspects of ROM use:

1. **ROM CONTROL** - Ability to activate at random any of the ROMs present in the Micro.
2. **BBC MICRO's STATUS** - e.g. Checksum on any ROM, and the Filing system currently active.
3. **ROM DEVELOPMENT** - Allows main memory to be used like Sideways RAM.

The Commands available are:

- ***CHECKSUM** - generates a CRC for the specified ROM.
- ***DIRECT** - allows you to pass a particular command to the specified ROM.
- ***EXAMINE** - allows examination of the named ROM.
- ***EXPLAIN** - gives detailed description of the first 22 FX codes.
- ***FILE** - passes the command directly to the currently selected filing system.
- ***FUNCTION** - displays the string currently programmed onto the function keys.
- ***INCLUDE** - allows he main memory to be used for developing ROM software without need to purchase expensive sideways RAM.
- ***MODIFY** - any location in memory is displayed and can be modified with this command.
- ***NAMES** - displays the names of any resident ROMs.
- ***RAM** - allows the command to be passed directly to the 'RAM based ROM'.
- ***REMOVE** - turns off the 'RAM based ROM' option.
- ***SPECIFY** and ***DEFAULT** - specifies the default ROM and passes the named command to the default ROM specified.
- ***STOP** and ***START** - allows the named ROM to be disabled or enabled, preventing clashes between ROMs.
- ***STATUS** - provides information about the ROMs inside the BBC micro, including the socket number, the name of the ROM, its length, whether or not it is enabled and supports language or service entry points.
- ***VALUES** - outputs information concerning the status of ROM MANAGER e.g. the socket number it occupies, the number of active ROMs with a higher priority than itself, the current filing system.
- ***VECTOR** - the same function as *DIRECT, but provided in case *DIRECT clashes with other ROMs.

In our opinion this ROM is one of the most useful utility ROMs available on the market, and is a must for anyone using ROM based software.

Price: **Only £21**

ADE

The complete program development package on 16K ROM. A must for all the Assembly Language Programmers.

SPECIAL OFFER £49

ACCESS HOT LINE

Tel: 0923 50234

BEEB MON

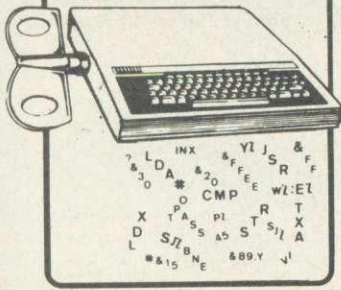

Watford's own Machine code Monitor ROM written by Andrew Bray (Cambridge), co-author of the BBC Micro Advance User Guide.

The most powerful and versatile machine code monitor ROM yet written for BBC Micro. It has all the normal memory editing, moving and relocating facilities, plus all editing is with a full screen editor allowing scrolling up and down memory, entering in Hex, ASCII or standard assembler mnemonics.

In use as a debugging tool, you run code under a total emulation system. Ever felt a desperate urge to set a break point in ROM? No problem - you can even have breakpoint on reading or writing locations in memory and on register contents. The system fully supports debugging of sideways ROMs e.g. BASIC can fully and easily be run from within Beebmon and from there DFS and other sideways ROMs can be used in total emulation mode. Beebmon can even run itself. In so doing you can nest Beebmon up to a level limited only by the memory size. Beebmon uses 256 bytes of workspace, located anywhere in memory, even on the 1MHz Bus. Beebmon effectively uses no zero page workspace, so your program (e.g. BASIC) can use any or all of the base page. How does it achieve this? By providing a 6502 interpreter all programs running under it exist in a virtual BBC, so special memory locations like the ROM latch are not actually accessed by your programs, instead they alter a location in Beebmon's workspace. Emulation also allows immediate return to Beebmon command level by ctrl-escape no matter what code is being executed at the time. All this exceptional power and flexibility is complemented by a clear and detailed manual included in a value for money price of:

£22

Disassembler Rom



Discover the hidden secrets of BASIC and the OPERATING SYSTEM with this easy to use programmers tool.

A ROM based machine code Disassembler for the BBC micro. It enables machine code programs to be listed in BASIC/DUMP format and thus is the perfect complement to the built in assembler. It allows Sideways ROMs, files on disk or tape to be listed, and also has a comprehensive editor, allowing mnemonics to be altered directly, as well as HEX, DECIMAL, ASCII and BINARY memory editing. There is also a full set of labelling facilities available (up to 3,200 labels), with the major locations and routines already labelled.

Thus DIS-ASM enables any monitor program, such as BEEBMON to be used to much greater effect as it is not necessary to disassemble memory each time the display is altered.

ONLY £18

WATFORD - Always a step ahead

COMPUTER CONCEPT'S ROMS

CARETAKER Basic Utility	£28
Graphics ROM	£28
Disc Doctor ROM	£28

Wordwise

Without doubt a very sophisticated piece of software for the BBC Micro. It has all the features of a professional word processor yet is easy to use.

SPECIAL OFFER THIS MONTH: £32

THE INVESTIGATOR

Now you can make up back-up copies of all your Discs. Put the precious originals away in the safe and use your duplicates. See what your 8271 can do! With Watford's Investigator you can find out about track formatting, sector length, etc. Investigate your disc and then make up your back-up copy. Disc based software includes a comprehensive manual.

Price: £15

(Please specify 40 or 80 track when ordering)

LIGHT PEN for BBC Micro



This versatile lightpen is very easy to use. It allows you free hand drawing in all colours. Has Special effects facility and many educational uses. An ideal and easy way of communicating with Micros for Children.

Only: £20

(Price includes our highly sophisticated PENPAL Lightpen software on Cassette. Please add £2 for software on Disc)

GAMES SOFTWARE

ADVENTURE QUEST (L.9)	£8.50
COLOSSAL ADVENTURE (L.9)	£8.65
CHESS	£6.95
CHUCKIE EGG	£7.90
CRAWLER (WESOFI)	£5.00
CROACKER	£6.95
DUNGEON ADVENTURE (L.9)	£8.50
Escape from MOONBASE ALPHA	£6.95
FELIX in the FACTORY	£6.95
GALACTIC COMMANDER	£6.95
KILLER GORILLA	£6.95
MUNCHYMAN	£5.95
MOONRAIDER	£6.95
MUSIC SYNTHESISER	£8.25
PENGO (Watford)	£6.95
SNOWBALL (L.9)	£8.50
SWOOP	£6.95
Twin Kingdom Valley	£8.25
747 FLIGHT SIMULATOR	£7.75

NEW LAUNCH

Watford Electronics' 32K RAM EXPANSION BOARD FOR THE BBC MICROCOMPUTER

Now Watford Electronics brings you the latest state-of-the-art memory expansion board for your BBC microcomputer. This compact board which fits inside the computer does not just give you 16K or even 20K of extra RAM, but a massive 32K!!!

There are many useful facilities available with this board:

- The top 20K of the expansion RAM can be used as the screen display memory, leaving all the standard BBC RAM free for programs or data storage. This allows good graphics and long programs to be combined. For instance you could have MODE 0/1/2 GRAPHICS AND 28K OF PROGRAM SPACE. The extra memory can be used by virtually any language or utility such as BASIC, VIEW, WORDWISE, etc.
- The full 32K or the bottom 12K of the expansion RAM can be used as a buffer for the printer, sound channels, RS423, keyboard or speech synthesiser. This allows very long text files to be printed while you are using 27K of program and 20K of graphics!
- This board is the ideal complement to any word processing system. There is no need to wait for slow printers as you can type in long text in 80 column display mode while printing is going on - TWO JOBS DONE SIMULTANEOUSLY!!! (an equivalent printer buffer would cost you £115+).
- The board is compatible with a vast range of software and hardware available for the BBC microcomputer, including our ROM expansion board and double density DFS.
- The board is extremely easy to fit. It is supplied complete with a comprehensive manual and ROM based software with full *HELP messages.

SPECIAL INTRODUCTORY OFFER

Only: £79 (carr. £1)

GRAPH PAD

With this popular British Micro's Graph-pad, you can add new dimension to your computer enjoyment. It helps you to create your own application programs by the simple use of the Graphpad. Ideal for Educational use. Supplied complete with Cables, Manual and a two program cassette.

Price: £115

SURGE PROTECTOR Plug

Safely eliminates dangerous voltage surges. During a thunderstorm, a nearby lightning strike can induce high voltage spikes in the voltage supply or fluctuating loads can also result in transient overvoltages which if unchecked, lead to expensive data corruption/loss. Our surge protection plug will provide the necessary surge protection. Simply replace your standard 13Amp mains plug with the surge protection plug (which is almost the same size). Ideal for computers, Hi-Fi systems, precision instruments, fridge freezers, etc. Max. surge current 2KAmp; Max. Voltage 250 Volts. A must for all serious computer users.

Price: £8.95

WATFORD ELECTRONICS

Continued →

MK 2 13 ROM SOCKET

EXPANSION BOARD

Now all lines fully buffered – On board battery back-up facility – will now accept EPROMS 2716, 2732, 2764 & 27128 and ROMs 6116 & 6264.

Simply plugs into one of the four ROM sockets currently available in BBC Micro. There are only 5 solder connections to be made. Full instructions are supplied. This board has been ergonomically designed to enable the user, easy further expansion inside the Micro, e.g. Double Density Board, Torch Board, etc. (At Watford, we think ahead.)

Our Mk2 13 ROM Socket Board enables the User to increase the sideways ROM capacity from the basic 4 sockets upto full 16 capable of being supported by current operating systems. In addition the board is designed with the facility to hold upto 16K RAM, which when switched into operation is automatically selected by any WRITE signal to the Sideways ROM area. This gives the User the ability to write a utility or language and upon pressing break have the utility or language up and running (new ROM software can be developed and tested in situ.)

The Board gives the User, plenty of freedom to explore the possibilities of the new paged ROMs due in the coming months and offers them the chance to develop their own.

All lines are fully buffered and the Board meets or exceeds all timings for operation in the BBC Microcomputer. When fully populated, the ROM Board consumes less than half the recommended maximum current limit.

Supplied ready-built and tested complete with fitting instructions.

ONLY £32.50 (carr. £1)

Versatile **BEEB SPEECH SYNTHESISER** Unit



SIMPLY the best! – An unlimited speech synthesis system. Complete with easy-to-follow manual. Controlling software is in ROM so no Cassette Loading problems!

PHONEMES for word synthesis – That means unlimited vocabulary! No extra speech dictionary chips to buy!

BUILT-in Library of approximately 500 words to get you started.

ENGLISH accent – Utilises inflexion techniques to produce highly comprehensible speech.

EASY to use system – Just plug the software ROM into a socket, the Speech unit into the User Port, and away you go! No specialised 'dealer upgrade' required!

COMPACT unit – The whole system is built into a small case – easily tucked behind the computer. Auxillary output socket provided for direct connection to an external amplifier.

HOURS of fun! – Suitable for any application – Games, Educational Programs, Specialised Packages.

We know this all seems to good to be true but **DON'T BE LEFT SPEECHLESS!** Order your Versatile Speech Unit now!

Only £44

WATFORD'S LAUNCH OF THE YEAR APEX

The ultimate expansion system for the BBC microcomputer. It enables you to increase memory capacity to 2+MEGABYTES including BATTERY BACKED-UP RAM.

The system consists of a mother board which fits inside the BBC and further daughter cards can be connected externally.

The internal card has the following features:

- 15 ROM/RAM sockets, 11 of which can be configured as 2716, 2732, 2764, 27128 EPROMS or ROM equivalent devices or as 6264 RAMs. Any RAM is Automatically battery backed-up and it's contents preserved when the power is turned off.
- The battery is recharged every time the machine is turned on and lasts several months, depending on the number of RAMs fitted.
- There is very little extra current drain, even with a fully loaded board as only the presently active ROM is powered up. In fact the fully populated board uses only 300mA.
- The board reduces micro bus loading by up to three ROM loads, which improves reliability and performance.
- Installation is extremely simple. There is no soldering required. The board is rigidly held by two 40 pin sockets and five support posts. A ribbon cable can be brought outside the computer and up to 8 external cards added. This enables the user to plug-in up to 142 paged ROMs. The cards have following features:

- Each card can accommodate up to 16 devices each of which can be configured as 2716, 2732, 2764, 27128 ROMs or 6264 8K RAMs.
- Battery backup is provided from the internal card.
- Only the active ROM is powered up permitting many external ROMs to be added with very little current loading (/100mA per card/).

The system comes with controlling software in ROM. The utilities supplied are as follows:

- APEX – replies with the device number currently being accessed.
- APEX C – toggles between the colour and standard black and white messages.
- AL – loads from any device, regardless of the data type.
- AS – saves memory to any specified RAM device.
- AD – prints a directory of the devices present in the system, i.e. ROMs present and files stored. This also reports on the amount of free storage space.
- AF – asks for the free RAM devices.
- LA – repeats the last command to paged ROMs.
- AT – enters a memory testing routine. This will write a test pattern into the memory and read it back out again. If a fault is found, it is reported to the user. This test continues until Escape is pressed.
- RDISC – activates APEX as a filing system which then treats all free APEX RAM in the system as a continuous 'RAM-DISC'. All commands have similar format to the DFS and transfer is possible between the two systems.

The complete computer system bus is available to the user, so that other cards/devices could be added such as EPROM programmers, second processors, Winchester disc drives, clocks, etc. By racking the cards you eliminate the tangled mass of cables that usually accumulates around the micro.

A comprehensive operating manual is supplied with every APEX Board. Please write in for further details and prices.

BEEBFONT ROM

BEEBFONT is a remarkable new concept in BBC software, exclusively available from Watford. Once fitted, the 16K ROM will enable you to produce attractive text displays in following different styles:

- ★ It works in modes 0, 1, 2, 4, using full colour.
- ★ Simply use Ctrl-V to select the font and all further screen output will be in a new style.
- ★ Even the ordinary Beeb character set can be enhanced by doubling height or width and emphasising to give bold print.
- ★ A comprehensive editor is included which enables the user to design his own characters.
- ★ A spooling program is provided, which enables pre-formatted text files to be displayed on an EPSON FX, RX, and NEC Printers, using the full range of character styles. (Please specify printer type when ordering). Can be used with WORDWISE.
- ★ This really must be one of the most original and exciting products of the year.
- ★ A twenty page manual is provided and the demo/editor software comes on disc or cassette (please specify when ordering). **ONLY £39**

THE ULTIMATE DFS FOR BBC MICRO

by

 **Watford Electronics**

Highly acclaimed at The ACORN and BBC MICRO USER Shows. What do the independent press say?

Good value for money – *Beebug Aug. '83*
A very worthwhile package – *The Micro User*
You'll be buying a very powerful package – *Personal Computer News*
Superior DFS; Excellent disc sector editor – *Computer Answers*

Without a doubt, the most sophisticated DFS Software yet written for BBC Micro Computer. This powerful new DFS is fully compatible with ACORN DFS yet has much increased power due to additions, carefully designed to make life easier in normal use. It consists of over 14K of efficiently written machine code. It is entirely self contained and so does not require a utilities disc to function.

Please write in for full technical specification.

PRICES:

DFS (Disc Filing System) ROM **£29**

Complete Disc Interface Kit including DFS ROM & Fitting instructions £99

Disc Filing System Manual. Comprehensive and clearly written **£7.50 (no VAT)**

P.S. We will exchange your existing ACORN DFS or PACE (AMCOM) DFS for Watford's highly sophisticated 16K DFS ROM for **£25**

Watford's DFS is exclusively available from Watford Electronics. We do NOT retail through any dealers. Every ROM carries a label with our LOGO and a serial number.

Now available:

Acorn DFS Kit **£95**

EPROMs & CMOS RAMs

2764-250nS (8K ROM)	£5.95
27128-250nS (16K ROM)	£24.00
6116-150nS (2K RAM Low Power)	£5.75
6264-150nS (8K RAM Low Power)	£28

WATFORD'S BEEB PRINTER ROM



Are you fed up with not being able to unravel your printer manual and use all those features you paid for? Need sensible paging for use in the creation of booklets? Then you certainly need our Beeb Printer ROM.

A machine code printer utility in ROM.

- 'Single' key operations replace control code sequences for underline, font and size selection, paper movement, etc. Up to 30 come pre-defined, without effecting normal fn key usage.

- **This rom allows easy control of your printer from 'Within' WORDWISE text. Instead of long escape sequences, you just 'OC' a single number to Select, Underline, Print Styles, etc.**

- Automatic fanfold page margins. Puts gaps in listings. PRINTed text etc to skip the folds. The gap size alternates to minimise paper wastage when using binders.

- Form feed and related commands, made available on ALL printers. Can also provide a left margin.

- User defined characters embedded within text are printed as on VDU.

- Commands select option for GP100, STAR, NEC, MX/FX, LP VII/DMP100, DMP200. Operates with Parallel and Serial Printers.

- Fully functional with the popular WORDWISE wordprocessor.

Supplied complete with a comprehensive 50 page manual.

Price: £24

(When ordering, please specify printer type)

DUMPOUT 3

A highly sophisticated machine code ROM providing screen to printer dumps in any mode, plus window setting utilities and two new OSWORD calls that allow you to use the Beeb graphic coordinate system for plotting or testing mode 7 'pixels'.

*GIMAGE Ultra sophisticated dump of any graphic screen, using up to 8 tones. Handles **FULL MODE 7 text**, graphics, double-height and colour and mode 8. 14 optional parameters, using 'prefixing' so that you only need specify the ones that you want. The parameters include:

- V<scale>, H<scale>. These are both 2 byte numbers giving you very fine control over the dump size from minute to enormous. Unlike other dump Roms, scale does not vary with screen mode.

- R <0-3> Dump rotation 0, 90, 180, 270 degrees.

- I<indent> Set gap from left edge of paper.
- X <min> <max>. Y <min> <max>. The area of the screen dumped is that in the graphics window, alternatively these parameters may be given.

- P Physical colour values used for dumping. (Otherwise use a negative scale, i.e. white prints darkest.)

- T Two tone dumps for higher resolution.
- M <mask> 8 bits controlling colour masking.
- E Contrast expansion. Makes mode 7 text characters and separated graphics stand out more clearly from the background.
- C All mode 7 graphics printed as reduced size dumps.

- *GWINDOW Draws graphic window on screen, its size and position can then be altered using the cursor keys.

- *TIMAGE <indent> Does a fast, text only dump of the text window in any mode.

- *TWINDOW As GWINDOW but for text. DUMP OUT 3 gives you ALL of the GIMAGE facilities listed above and GWINDOW in mode 7 as well, not just hi-res modes.

Ideal for CP80, GP80, DP100, GP250, STAR, KAGA/TAXAN, NEC, SHINWA, CP80, GEMINI, EPSON MX/RX/FX, LPVII, DMP100/120/200/400 Printers. Comprehensive Manual included.

Only £22

APPROVED for use with telecommunication systems run by British Telecommunications in accordance with the conditions in the instructions for use.

 **Watford Electronics**

MODEM 84 For BBC Microcomputer

With the launch of Watford's MODEM 84 you can now hook into PRESTEL, MICRONET, HOMELINK, TELECOM GOLD, etc., for about the cost of a good tape recorder. Prestel gives you access to an incomparable database covering almost every subject under the Sun. There is Micronet with lots of free programs that you can download and run. Details of Clubs and User groups, a diary of meetings and exhibitions, news and reviews, technical information, etc. There is Homelink with On-line banking. And there is armchair shopping, travel information, Entertainment, World News, Sports News, Business News, Weather information, Electronic mail and lots more. The basic Prestel subscription is only £5 per quarter for domestic user and at off-peak times there is no charge for access time. Can you afford not to be part of this revolution?

Now using the latest techniques and the new generation of Modem chips, Watford have developed a Modem that is newer, better and yet cheaper than any on the market.

Compare the Specifications:

MODEM

- Direct-connect Modem using BT approved isolation components.

- Full Duplex V23 operation for Prestel and TELECOM GOLD operation (1200/75 Baud).

- User-to-User half duplex 1200/1200 Baud operation with AUTOMATIC SEND/RECEIVE switch (BEWARE - most MODEMS switch manually between send and receive, which precludes the use of intelligent user-to-user software).

- Simple single button operation and comprehensive LED status display.

- Attractively finished. Sized to sit on the Disc drive.

FX80 PRINTER DRIVER for VIEW

Do you want to use Italics or Enlarged Characters with View? French or German Characters? These and other FONTS from FX80 character sets can be accessed using our Printer Driver with VIEW. The disc contains an example as well shows how to use. Available on 40 or 80 track Disc. **ONLY: £9**

EPSON DUMP ROM

A specially designed Dump ROM for EPSON RX, FX and the new Kaga KP810 Printers. Will accurately DUMP all Screen modes including TELETXT, GRAPHICS and DOUBLE HEIGHT. MULTITONE DUMPS are also supported. Simple single command (*SCDUMP) operation.

Only: £20

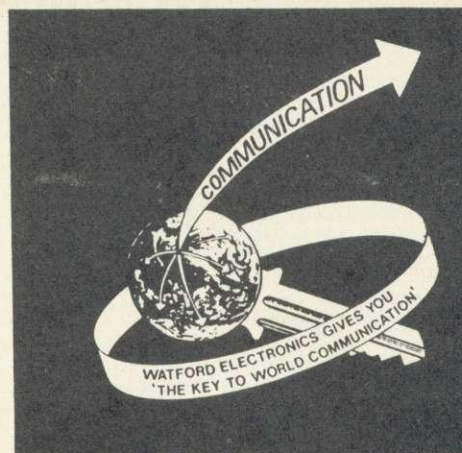

NEW SUPER PRESTEL INTERFACE ROM

Fully compatible with Watford's MODEM 84 as well as with PRISM and most other Modems.

- Supports full Prestel Colour Alpha and Graphic Characters including Double Height, Flashing, Conceal/Reveal.

- Called by simple *PRESTEL command. Disc and Tape configurations fully supported.

- Telesoftware downloader included.

- Comprehensive MAILBOX facilities including offline editor.

- Auto Logon sequence, can be burnt into ROM if desired.

- Unique "TAG" facility allows tagging and recall of interesting pages - avoids the common and annoying 'NOW WHERE WAS THAT PAGE' problem.

- Page load and save to tape or disc. Pages are automatically saved under Page Number reference in a 'FRAME' directory.

- Print page options are ASCII only (i.e. with suppression of Graphics) - fast and works with any printer - as well as a full graphics dump for the popular Epson printer.

- 'USER' function call built into interface with specialist add-on routines (your own as well as ours).

- All the above facilities available from Function Keys. An overlay is provided giving simple yet comprehensive guidance to the key functions.

- Comprehensive instruction manual supplied.

PRICES:

SOFTWARE ROM incl. Comprehensive Manual £20

MODEM 84 (without software) £62

MODEM 84, SOFTWARE ROM and Operating Manuals **ONLY: £82** (£2 carr.)

(Please allow upto 28 days for delivery)

Please write to Watford Electronics for full details, Order and Application Forms.

TINY PASCAL for BBC Micro £59

VIEW

Wordprocessor (New version) £49

FORTH ROM for BBC

This superb (FIG FORTH) compiling language now available in ROM. Simply plugs into one of the ROM Sockets. Manual included. **£33**

**WATFORD
ELECTRONICS**

Continued 

BOOKS (No VAT on Books)

30 Programs - BBC Micro	£3.25
30 Hour BASIC (BBC Micro)	£6.95
35 Education Programs for BBC	£6.95
36 Challenging Games for BBC	£5.95
40 Educational Programs for BBC	£5.95
100 Programs for BBC Micro	£6.95
Cassette version of above	£10.00
6502 Application Book	£11.95
6502 Assembly Language Program ..	£13.95
6502 Assembly Language Subroutines	£14.25
6502 Machine Code for Beginners ..	£5.95
6502 Software Design	£10.50
A young persons guide to BBC Basic ..	£4.50
Advanced Machine Code Technique for BBC	£7.95
Advanced User Guide for BBC Micro	£11.95
Advanced Graphics with BBC	£9.95
Advanced 6502 Interfacing	£10.95
Advanced 6502 Programming	£12.45
Assembly Language Programming on BBC Micro	£7.95
Advanced Programming Techniques for the BBC Micro	£7.95
BBC Basic	£7.95
Assembly Lang. Prog. on BBC	£7.40
BBC BASIC	£5.95
BBC Basic for Beginners	£6.95
BBC DIY Robotics & Sensors	£6.95
BBC Forth	£7.50
BBC Lisp	£7.50
BBC Micro An Expert Guide	£6.95
BBC Micro Book BASIC Sound & Graphics	£7.95
BBC Micro Graphics and Sound	£6.95
BBC Micro Programs in Basic	£5.95
BBC Micro ROM PAGING System Explained	£2.50
BBC Micro Revealed	£6.95
BBC Micro Assembly Lang. Prog.	£7.95
BBC Micro Disc Companion	£7.95
BBC Micro in Education	£6.50
Basic Programming on BBC Micro	£5.95
Best of PCW Software (BBC)	£5.95
CP/M Users Guide	£13.95
Creating Adventure Programs on BBC Micros	£6.95
Creative Graphics Cassette (Acornsoft). Has 36 graphics programs	£8.95
Creative graphics on BBC Micro	£7.50
Complete Programmer for BBC	£5.95
DISC FILING SYSTEM (DFS) Operating Manual for BBC	£7.50
Discover BBC Machine Code	£6.95
Discover FORTH	£13.95
DIY Robotics & Sensors with BBC	£6.95
Further Prog. for BBC Micro	£5.95
FORTH Programming	£14.40
Functional Forth for the BBC Micro	£5.95
Games on your BBC Micro	£2.95
Games BBC Computer Can Play	£6.95
Graphs & Charts on BBC Micro	£7.50
Graphic Art for BBC Computer	£5.95
Graphs and Charts (Cassette)	£7.50
Graphics on BBC Micro	£6.95
Hobbit (Book and Cassette)	£14.95
Introducing the BBC Micro	£5.95
Introduction to FORTH	£9.30
Intro to Micro Beginners Book (3 Ed.)	£9.90
Let your BBC teach u to program	£6.45
LISP	£9.25
Logo Programming	£8.95
Mastering VISICALC	£12.45
Mastering CP/M	£13.65
Micros in the Classroom	£4.90
Programming the 6502	£11.95
Programming & Interfacing 6502	£16.00
Programming the BBC Micro	£6.95
PASCAL	£9.25
Programming for Education on BBC	£5.95
Structured Prog. with BBC BASIC	£6.50
The Complete FORTH	£6.95
The BBC Micro Book, BASIC, SOUND & GRAPHICS	£7.40
Using Floppy Discs with BBC Micro	£5.95
Using BBC Basic	£6.95
Using 6502 Ass. Language	£14.50
Wordstar & CP/M made easy	£6.95

DOUBLE DENSITY BOARD

We are proud to announce the launch of our Double Density Board for the BBC Micro. The DDFS software that we supply is a version of our highly acclaimed standard 16K DFS for the BBC Micro. It has all the features of the single density DFS. Allows single files upto 359K. It will automatically tell whether a single or double density disc is being accessed, as well as allowing the option of reading 40 track disc on an 80 track drive. Now on your 80 track Double Sided Drive you will have 720K storage instead of the usual 400K and with higher speed than ever before (of course this is a BONUS at NO EXTRA COST). Complete Double Density Upgrade Unit will cost same as single density Kit.

Delivery 4 weeks (approx).

DATA RECORDER & ACCESSORIES

Top quality Slimline, portable Data Recorder for computer use. Mains/Battery, operated with counter

DATA RECORDER CABLE £22.00

For our Data Recorder to BBC Micro £2.50

DATA CASSETTES Top grade C12 Data Cassettes in library cases. 36p

ATTACHE CARRYING CASE for BBC Micro

These Attache Carrying cases are attractively finished in mottled antique brown leatherette. An ideal and very safe way to carry your BBC Microcomputer. Price: £12 (£2 carr.)

This space reserved for our 'Launch of the Year' Hardware

This space reserved for yet another launch of our Hardware for the BBC Microcomputer. - to be unveiled at the Acorn User Show OLYMPIA - LONDON, August 1984.

VOLTMACE'S DELTA 14 Hand-set

Price: 'Delta 14' Hand set £12.50
ADAPTOR MODULE £12.55
TRANSFER PROGRAM Tape £5.10
Disc £7.95

JOYSTICKS for BEEB

Two versions available:

SINGLE: Player type £7.00 each
TWO Players type £12.00 per pair

Prices subject to change without notice and availability.

MAIL ORDER AND RETAIL SHOP. TRADE AND EXPORT INQUIRIES WELCOME. GOVERNMENT AND EDUCATIONAL ESTABLISHMENTS OFFICIAL ORDERS ACCEPTED. CARRIAGE: Unless stated otherwise, please add 75p to all cash orders.

VAT: UK customers please add 15% VAT to the total cost incl. Carriage.

SHOP HOURS: 9.00am to 6.00pm. Monday to Saturday. (Ample Free Car Parking Spaces)

ACCESS ORDERS: Simply phone: Watford (0923) 50234. (24 Hours)

PLINTH FOR BBC MICRO

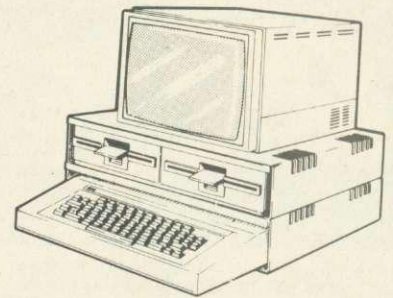

Protect your micro from the weight of the heavy TV/Monitor. This sturdy plinth is attractively finished in BBC colour. Air vent slots have been provided to allow maximum air circulation. It can be used to support a monitor or a printer. The micro slides underneath comfortably. A must for every BBC Micro owner, specially for those who have to move/open their computer frequently.

Single Decker £11 (carr. £1.50)
Double Decker £20 (carr. £2.00)

PLINTH FOR PRINTERS

Keeps your desk tidy. Place the printer on the plinth and the paper underneath. Finished in BBC colour.

£10 (carr. £1.50)

4 WAY MAINS DISTRIBUTION SOCKET

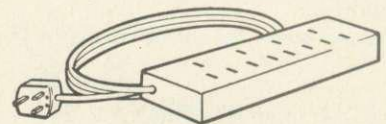

A highly versatile space saving solution when multi-power outlets are required. Can be wall or floor mounted. Ideal for Micro Computer and peripherals application. Prevents you getting a dangerous tangle of plugs and adapters.

Only: £9.50

READY-MADE LEADS

CASSETTE LEADS 7 pin DIN Plug to 5 pin DIN Plug + 1 Jack Plug £2.00
to 3 pin DIN Plug + 1 Jack Plug £2.00
to 7 pin DIN Plug £2.50
to 3 Jack Plugs £2.00
6 pin DIN to 6 pin DIN Plug (RGB) £2.50
Monitor Lead, BNC to PHONO £3.00
Disc Drive to BBC Micro Power Lead
Single: £3.00 Dual £3.75

MISCELLANEOUS CONNECTORS

	Plugs	Sockets
RGB (6 PIN DIN)	30p	45p
RS423 (5 pin Domino)	40p	50p
Cassette (7 pin DIN)	25p	65p
ECONET (5 pin DIN)	20p	30p
Paddles (15 pin 'D')	110p	215p
BBC Power Plug 6 way	80p	-
Disc Drive Plug 4 way	75p	-

Watford Electronics

Dept. BBC, Cardiff Road, Watford, Herts, England.
Telephone: 0923 40588/37774. Telex: 8956095

◀ page 37

actually play the game watch how it works. You'll then have an idea as to how the Paras reach one side of the screen and then reappear on the other side.

Press ESCAPE and run the program again, this time taking up your position to shoot the Paras. Move one space in front of the target so that, if the Para is coming down from the right, you position yourself one space to the left and keep your finger on the fire button.

As you progress you'll find that it takes longer for it to register when you hit a Para. This is because in PROC-PARAS more and more Paras come down as the loop gets bigger. The Para you hit may be PARA\$(16). This means that it will have to go through the loop 16 times before it registers. You might find this frustrating but it adds to the fun of the game and would be too easy if it registered as soon as the laser hit the Para.

I hope you enjoy playing *Paranoids* and beat my own highest score, which was 11,850 on level 19 (on an Electron).



Turn to yellow pages iii and iv for the paranoids program

INTEGER VARIABLES

- LIFE%
- LIVES%
- HIT%
- LAND%
- PARA%
- T%
- SCORE%
- LEVEL%
- L%
- FIREX%
- FIRE%
- P%
- D%

FUNCTION

- Registers whether a Para lands.
- A counter for the number of lives lost.
- Adds up the number of Paras hit.
- Adds up the number of times a Para has landed.
- Increases as the number of Paras increases.
- Current X co-ordinate of tank.
- Current score.
- Current level.
- General-purpose loop counter.
- For calculating the position of the laser.
- The actual calculated laser position.
- The pitch used in PROCFANFARE.
- The duration used in PROCFANFARE.

STRINGS

- SPACE\$
- explode\$
- tank\$
- A\$

FUNCTION

- Used to cover a Para when it is moved or hit.
- The explosion used when a Para has been hit.
- The character used for the tank.
- Used for producing the beeps when a life has been lost.

ARRAYS

- PARAX%(30)
- PARAY%(30)
- X%(30)
- Y%(30)
- PARA\$(30)

FUNCTION

- Current X position of the Para.
- Current Y position of the Para.
- The X increment when moving the Para.
- The Y increment when moving the Para.
- The Paras' actual character.

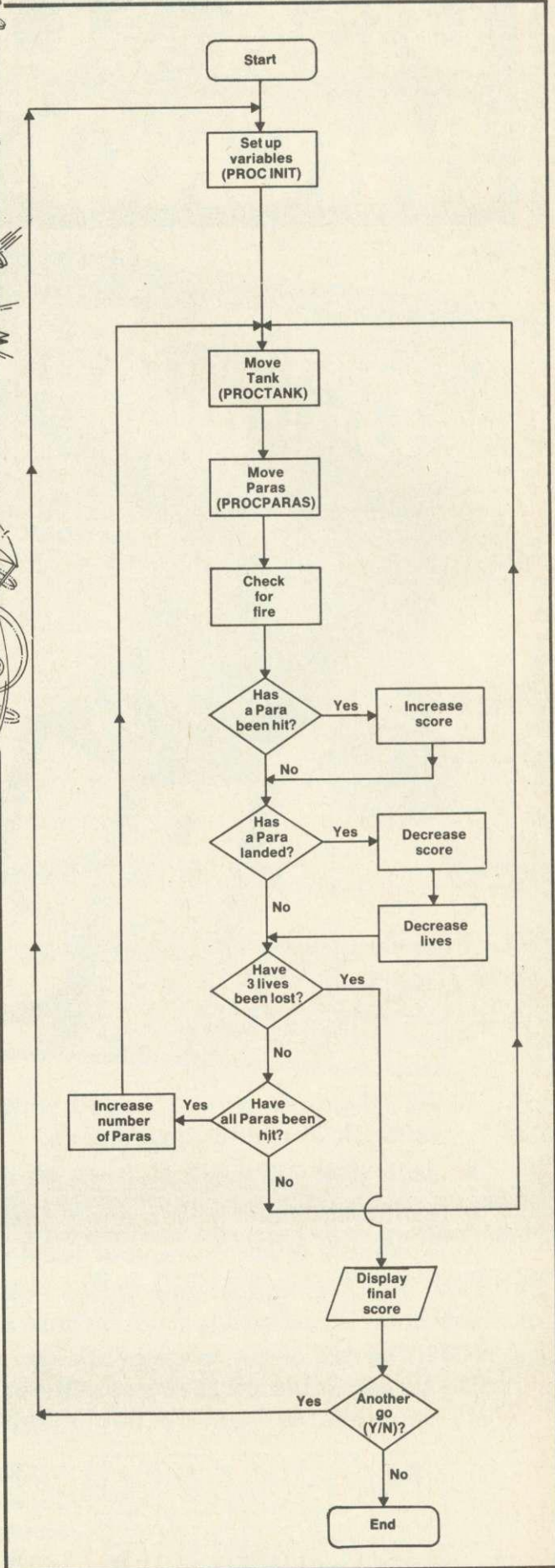

Figure 1. Flow-chart of the action in the 'Paranoids' program (above)

Figure 2. Variables table for 'Paranoids' (left)

SERIOUS SOFTWARE from BEEBUGSOFT.

Masterfile

MASTERFILE is a general purpose data base, written especially for the BBC Micro. It is extremely useful, allowing vast amounts of information to be quickly stored.

Once set up, the information may be retrieved or sorted at any time, in a number of different ways, using any of the fields as keys.

Records may be instantly displayed or printed, using any printer suitable for the BBC Micro, also a label printing facility is included.

Separate versions of the program are available for cassette and disc based systems. The disc version uses random access files to maximise record storage.

One extra feature of the disc version is that it provides limited spreadsheet facilities.

Spellcheck

SPELLCHECK is menu driven, and is the ideal companion for **WORDWISE** or **VIEW**. It provides an automatic spelling check for letters or documents.

It is supplied with a dictionary disc already containing 6000 words, which may be increased to a maximum of about 17,000 words on a 100k disc.

Random access files ensure very fast word retrieval from the dictionary disc.

SPELLCHECK is menu driven, and is very simple to use, allowing unknown words to be added to the dictionary, ignored or re-spelt.

Incorrectly spelt words may be instantly respelt and a correct version of the document filed away, ready for printing or later use.

Dictionary discs for foreign languages may easily be created to help check letters sent abroad.

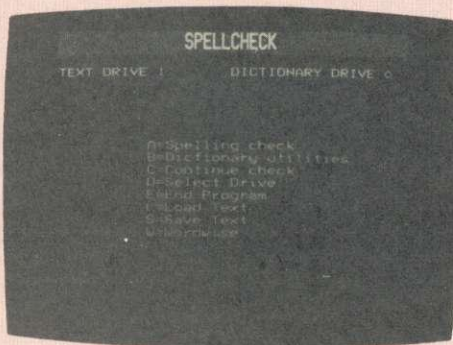

".... I found the program to be invaluable.... fast and reliable a worthwhile investment."
PCN FEBRUARY 1984

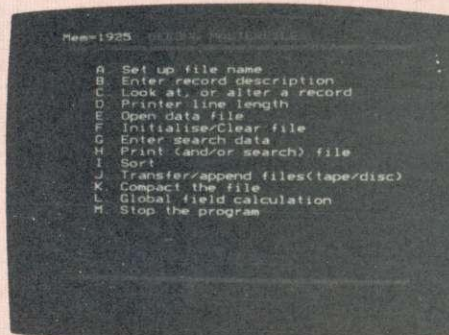

TECHNICAL INFORMATION

The cassette version will allow up to 10 fields to be specified per record. Any number of files may be set up, and each file may hold about 110 records (based on a typical 5 field record).

The disc version allows up to 17 fields per record, and the only limitation as to the number of records, is the capacity of the disc. Typically, using 5 fields, about 2000 records may be stored on a 100k disc.

".... Works well and offers an efficient data base...."
PCN NOVEMBER 1984

BEEBUGSOFT, P.O. BOX 109, HIGH WYCOMBE, BUCKS. HP10 8HQ

Please send me Spellchecks at £19.00 each. Masterfile disc(s) at £19.00 each.
.....Masterfile cassette(s) at £10.00 each.

Name

Address

All BEEBUGSOFT products are available from leading dealers including larger branches of W.H. Smith 

Send Cheque/Postal Orders to BEEBUGSOFT, DEPT. 13 P.O. BOX 109, HIGH WYCOMBE, BUCKS. HP10 8HQ
(Distribution agents for BEEBUG Publications Ltd.)

TOOLKIT ROM from BEEBUGSOFT

BASIC Programmer's Aid for the BBC micro

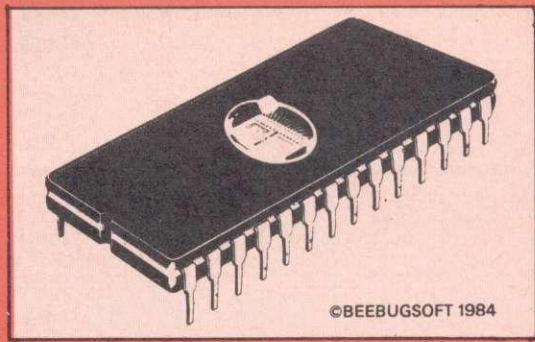

- 27 new commands to make life easier
- Saves hours in program development and debugging
- Supports both cassette and disc systems
- No command name conflict with other Roms
- Ideal for expert and novice alike
- Fitting instructions and a 32 page manual supplied
- You'll wonder how you ever managed without it

SPECIAL FEATURES INCLUDE

SCREEN EDITOR An extremely powerful editor, allowing the use of cursor keys to list a program line-by-line in either direction and move to any part of a program to overtype or insert new code and corrections.

ERROR DETECTION Powerful facility to trap an error in a Basic program as it runs. It will then automatically enter the Screen Editor, display the line in error and position the cursor close to the statement at fault.

"TOOLKIT is an essential utility for all Basic programmers using the BBC Micro. . . . The range is enormous. . . . an indispensable aid packed full of powerful utilities."

EDUCATIONAL COMPUTING MARCH 1984

"... highly recommended."

PCN MARCH 17 1984

"The Beebugsoft Toolkit costs £27 and in my opinion is worth every penny. Since it has been installed in my BBC it has been used extensively and I can find no fault with it. Highly recommended to lazy programmers!"

COMPUTING TODAY JUNE 1984

COMMANDS

*CHECK	Verify a program or data in memory with disc/cassette.
*CLEAR	Clear all variables including integers.
*EDIT	Enter full screen editor.
*FREE	Display free memory and pseudo variables.
*HELP INFO	Display a screenful of useful system information.
*MEMORY	Display memory contents.
*MERGE	Merge a program in memory with one on disc/cassette.
*MOVE	Move program to run at specified address.
*NEW	As NEW, but can be issued from within a program.
*OFF	Cancel enhanced error handling.
*OLD	As OLD, but can be issued from within a program.
*ON	Auto error handling—enters editor at line in error.
*PACK	Efficient program compactor.
*RECOVER	Intelligently recover bad programs.
*RENUMBER	Allow partial renumbering.
*REPORT	Extended error reporting facility.
*SCREEN	Screen dump to cassette or disc.
*UTIL	Display utilities menu.
*UTIL 1	String search.
*UTIL 2	String search and replace.
*UTIL 3	Move Basic program lines.
*UTIL 4	List procedures and functions.
*UTIL 5	List values of A% to Z%.
*UTIL 6	List numeric variables.
*UTIL 7	List string variables.
*UTIL 8	List names of arrays.
*UTIL 9	Set up range for utilities 1 and 2.

BEEBUGSOFT, PO BOX 109, HIGH WYCOMBE, BUCKS HP10 8HQ

Please send me.....Toolkit(s) at £27.00 each

Name

Address

Send Cheque/Postal Order to BEEBUGSOFT,
DEPT 13 , PO BOX 109, HIGH WYCOMBE, BUCKS HP10 8HQ
(Distribution agents for BEEBUG Publications Ltd.)

Available from your dealer
and selected branches of
W.H. Smiths

£27.00

Including
VAT & P&P



SEE ALSO BEEBUGSOFT DOUBLE COLOUR ADVERT IN THIS ISSUE.

Tricks up Martin Phillips' sleeve include fast random numbers, real numbers, drive and printer checks and how to save ribbon outlay

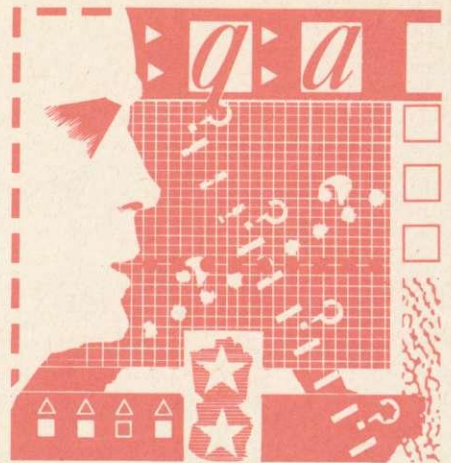

See yellow pages v and vi for all programs relating to this section

50

£5 Stepping through a listing

BEING able to slow listings down or stop them when the screen scrolls is obviously a useful facility. The easiest way to do this is to put the computer into what is called 'page mode'. This is done by keeping the control key pressed while the letter 'N' is pressed (usually this is referred to as CTRL-N). This will stop the computer listing a whole program without stopping. The computer stops when about two-thirds of the screen is full of information, and the next part of the listing will only appear when the SHIFT key is pressed. To switch page mode off, it is necessary to use CTRL-O.

However, when checking a long listing, page mode is not the complete answer. Paul Holgate has sent a useful function key definition program (listing 1) that allows the user to step through a program a few lines at a time. When function key f0 is pressed, a list command is inserted into the function key buffer and the screen cleared. It will list a group of lines in multiples of 10 from 0 to 9 each time key f0 is pressed. The start line number is held in the integer variable L%, and this is incremented each time the key is pressed. To enable any starting point to be used for listing, key f1 has been defined to input the start point from where the listing is to run. Key f1 must be used before attempting to step through a listing. The usual start point will be at line 10, although listings can start at line 0.

This routine could be modified to step back through the listing by defining another key similarly, but *decreasing* L% by 10 each time the key is pressed.

Essential brackets

I AM indebted to Paul Holgate for also supplying the following item. There are cases where opening brackets are actually part of the Basic keyword. With such keywords, the inclusion of brackets

is essential. Also there must be no space between the keyword and the bracket.

The following keywords require brackets:

```
RND    LEFT$ MID$  RIGHT$
STRING$ INSTR POINT TAB
```

Brackets may be omitted after the following keywords:

```
ABS    ADVAL ASC    CHR$
EVAL   EXP    INKEY INKEY$
INT    LEN    OPENIN OPENOUT
SGN    SPC    STR$  USR
VAL
```

Brackets may also be omitted from the mathematical keywords:

```
ACS    ASN    ATN    COS
DEG    LN    LOG    RAD
SIN    SQR    TAN
```

Random numbers

with strings

I WAS interested to see the routine for obtaining a 'perfect' sequence of 10 random numbers with no repeats in June's Beeb Forum (page 57). It occurred

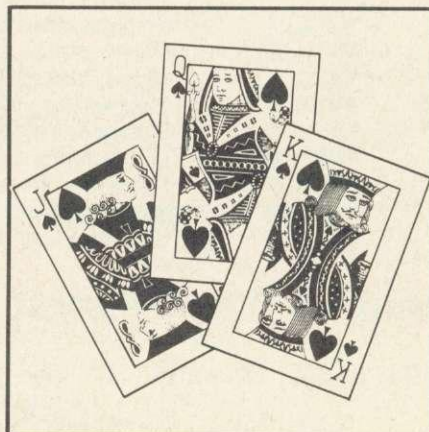

The ideal method for card games...

to me that the string functions could be used to perform a similar task. BBC Basic has quite a useful range of string-handling routines, many of which are underused.

Listing 2 shows my method. It is shorter than the Beeb Forum listing, which for the sake of completeness is repeated (listing 3). To my surprise, it is also on average 10 times as fast! Speed of performance was rather difficult to measure, as each run varied considerably depending on the luck of the draw. I therefore ran each routine 100 times to find the total time taken.

Listing 4 is included to show the idea for those interested.

This way of selecting a random sequence would be ideal in card games, as it is easy to include the jack, queen and king.

Listing 5 shows how this could be done. Notice that in line 80 the test to see if the number is already present includes the following space. This overcomes a problem that the test does not recognise the actual number but just a digit. In this example we need to include a 10.

The test as it stands in listing 2 will see a 1 present when it is meant to be a 10. The inclusion of the following space in the test prevents this from happening.

Listing 6 shows how the technique can then be extended to a full pack of cards. Surprisingly, it takes only some 5-10 seconds to select a full pack.

I hope these short programs will make readers take another look at strings and their possible uses, and maybe those who discover novel string applications will be prompted to send them in.

page 51 ►

IF YOU have a technical hitch or a programming problem let Martin Phillips give his diagnosis. We'll pay £5 if you raise a really interesting point. Please give full details of the system you're using and include a listing where appropriate, making your question as specific as possible. WRITE TO: Hints & Tips, Acorn User, Redwood Publishing, 68 Long Acre, London WC2E 9JH.

VDU in command

MORE and more programs are making use of VDU commands to replace those Basic keywords that are concerned with printing on the screen. Consider the following line from a program:

```
10 VDU12,31,10,10,72,69,76,76,79
```

This line will clear the screen, move to the position 10,10 and print the word 'HELLO' on the screen. However, it is not clear what the line does, unless one is familiar with all the ASCII codes and the VDU codes. It can be made more readable by using a print statement:

```
10 VDU12,31,10,10:PRINT"HELLO"
```

We could go a stage further and remove the VDU command altogether:

```
10 CLS:PRINTTAB(10,10)"HELLO"
```

Now the line is far simpler to understand. There must be an advantage to using the former method—memory perhaps. The first line of code took 34 bytes of memory, the second 28 bytes and the third only 24. Point taken?

VDU commands have their rightful place in programming, but use them with care and ensure they do not hinder understanding of the program.

Campaign for

real numbers

SEVERAL readers have had difficulty with money programs that will work out VAT and check totals etc. The problem was first highlighted in this column in December 1983. It is a problem that can affect many program applications, and many new readers have joined *Acorn User* since last year, so I make no apologies for repeating the point.

How do the BBC and the Electron handle numbers? Well, they differentiate between two types of numbers: real, which can contain a fractional part, and integers, which are whole numbers. Integer variables are distinguished by having a % sign as the last character of the variable name: eg, number% and count%. They can store only numbers between -2,147,483,648 and 2,147,483,647. Integer variables are stored with complete accuracy and are operated on more speedily by the computer.

There are also 27 integer variables which the *User Guide* calls the Resident Integer Variables. They are A% to Z% and @%, and have a permanently allocated space in memory. As a result, their values are not lost when RUN or NEW are entered, or even BREAK is

pressed. This enables values to be carried by these variables from one program to another. (Have you ever wondered how the WELCOME tape remembers whether your cassette has motor control from one program to another? It uses the resident integer variable M% to inform each individual program.) The @% variable has a special function, as we'll see.

Real numbers with a value between 2×10^{38} and 2×10^{-38} can be stored by the computer and can include negative numbers. The disadvantage with real numbers is that they can be stored only to nine-figure accuracy. (Basic 2, the version of Basic present on the Electron and new BBCs, will work to a 10-figure accuracy.)

The numbers must be converted to binary before being stored and this leads to many problems. Some numbers cannot be represented with complete accuracy this way. This is a similar problem to the recurring decimal found when 10 is divided by 3 or when trying to calculate exactly the value for the ratio of diameter to circumference of a circle. This ratio, called π , is a never-ending decimal, and can never be represented with total accuracy.

To illustrate the difficulty of storing and retrieving numbers accurately look at listings 7 to 9. Listing 7 works as one would expect, but with only a slight change in numbers listing 8 does not give the correct result. It is interesting to print out the values for A, B and C and see what happens to them. Listing 9 will do this. To add to the confusion, we find that it prints out the correct values even though the program has given the wrong result!

Before you throw your computer away and rush out to buy another make I should point out that this program will not function correctly on the majority of other micros. The reason is that the computer has a routine built into the PRINT statement to check for the correct errors in number storage and retrieval. Unfortunately there are no such routines in the equals, greater than or less than operators and these give rise to problems, particularly when trying to perform money calculations.

There are two possible ways round the problem. The first is to multiply the real numbers by 100 and work in integer arithmetic. To display the results divide them by 100. For the sake of simplicity we are assuming that half-pence will be ignored. Listing 10 gives an illustration of this method. Using the print format variable (@%), the figures are printed out to two decimal places. By using integer arithmetic it is possible to store values up to 2 million

pounds accurate to the nearest penny.

This method as it stands is not fool-proof, as real numbers still have to be stored in memory. Try adding £29.49 and £10. To get around this, instead of multiplying and dividing by 100, change the program to multiply and divide by 1000. This means that the real number is converted with a ten-fold greater accuracy. (It now also enables half-pence to be entered.)

The other cure is to use a relative test rather than trying to equate two totals exactly. As any value less than £0.005 has no significance in our monetary system, we can utilise this to provide a better test for totals agreeing: Listing 11 shows how this can be done. The ABS statement ensures that the test will work if either total is larger.

Disc detector

ON A BBC machine fitted with disc interface it is often useful to detect the presence of a disc drive during a program, say to give the option to save data on either disc or cassette. A way to do this is to assume that if a disc drive is fitted then the program will have been loaded from disc. If this is the case then *OPT2,1 can be used to differentiate between disc and cassette. It will give an error message with a disc filing system, but not with the cassette filing system. It gives error number 203 (bad option) with disc.

This could be detected to differentiate between tape or disc, or the line number at which the error occurred can be detected as in listing 12. To check that listing 12 will work (on a disc machine of course) type RUN, then press BREAK, which will rerun the program but with tape option selected.

The computer will remember the last error line until either a new error occurs or BREAK is pressed. This is why the BREAK key has been used in this program.

Printer check

SOME programs that make use of a printer tend to hang up if no printer is present. There's no easy way of getting out of such a situation at the time. It is better to include a routine in these programs that checks to see if a printer is connected first. The ADVAL statement can be used to check whether a printer is connected and switched on, and a little-known use for the statement is to check the state of the various buffers. ADVAL(-4) will check the state of the print buffer.

Listing 13 shows the technique. Two spaces (code 32) are sent to the printer

only (two are necessary as the first one disappears somewhere down the line and does not stay in the buffer), and then the buffer is tested to see whether it is empty. If it is, a value of 63 will be returned. If the space is held in the buffer then the value returned will be 62. This idea is easy to incorporate into programs.

Ribbon rewind

HERE is a tip that will double the life of some printer ribbons. Dot matrix printers use a continuous ribbon in a cartridge, which can often be prised open to get at the concertina'd ribbon. When the printing is becoming faint and a new ribbon is needed, try opening the cartridge and removing the ribbon. Replace the ribbon upside down and rewind the ribbon back into the cartridge. This trick works because many printers do not print in the middle of the ribbon, but near one edge, so reversing the ribbon allows the other edge to be used. Some cartridges are better designed, however, and the ribbon already has a half twist in it so that the top and bottom of the ribbon are both used - in which case this tip is no use!

Cassettes

under scrutiny

THE weakest link in the BBC or Electron computer system is the tape recorder. Cassette players were designed for audio work as a low-cost, miniature alternative to the reel-to-reel tape recorder. When used with a computer, the cassette is pushed to the limit of its performance. It is no use dusting off an old cassette that has long since seen better days, and wondering why no programs load from it. The cassette needs to be in tip-top condition.

However, problems can occur, even

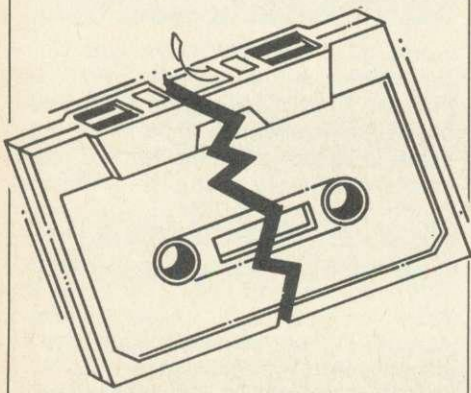

Weakest link in the system

with new cassette recorders. Mr Brazier of Kent sent in a tape that would not load a program he had saved. On listening to the tape a rhythmic beat could be heard on top of the normal tone.

This, I suspect is caused by one of two things. First, leaving the cassette's Play button down after the program has loaded. On a cassette that has motor control, this is all too easy to do - one simply forgets to switch off the cassette. Inside the mechanism is a rubber wheel which presses hard against the driving spindle when the cassette is in the Play or Record positions, and this assembly regulates the speed of the tape. If the rubber wheel is left in contact with the spindle for some time while the motor control is off, then a depression will form in the wheel that will usually spring out again in the course of time (but not always!). If the cassette is used in this condition, the sound will be distorted and load and save errors will be produced.

The second cause could be a small piece of dirt stuck to either the rubber wheel or the spindle, or even damage to one or the other. Similarly the tape speed will be uneven and cause tape faults.

Speedy circles

MR GLOVER of London has sent in two methods for speeding up circles. The first (listing 14) uses the trigonometric identities:

$$\begin{aligned} \cos(n+1)x &= \cos nx * \cos x - \sin nx * \sin x \\ \sin(n+1)x &= \sin nx * \cos x + \cos nx * \sin x \end{aligned}$$

The calculation of COS() and SIN() is done only once and the loop involves only multiplication, addition and subtraction, so the circle is drawn faster.

Listing 15 is even faster and would be very effective for a program that needed to draw many circles. The appropriate sine and cosine values are read into an array, which is then used in the circle procedure. This routine is slow, however, if the time taken to put the values into the array is also taken into account.

The on/off dilemma

MR SMITH from Surrey writes: 'I am in the habit of leaving my BBC micro switched on for up to 10 hours at a time. This is mainly for convenience of use, but also because I believe it to be bad

'Component overheating is a sure way to reduce life-span'

practice to switch the machine on and off too often - I understand that the stress caused by heat/cooling is one of the main reasons for early failure of electronic components.

'My question is: would it make sense to leave the machine (only) switched on continuously, even overnight? Does an unattended BBC present any kind of fire risk?'

The usual way the life of an electronic assembly is calculated is not in terms of the times it is switched on and off, but in terms of the number of hours of use, and how close each component is to its maximum operating conditions in use. Component overheating is a sure way to reduce life-span. If the components never get too hot then there will be less chance of premature failure, or stresses caused by heating and cooling, so my advice to Mr Smith is switch off the computer if he is not going to use it for some time.

Modern components are designed to withstand the stresses caused by heating and cooling within their normal working temperature range, and damage occurs only when the temperatures rise above this range. To leave the computer on continuously will reduce the life of the computer rather than extend it.

There is always a possibility of fire risk with electrical equipment, and unless the equipment is designed for continuous use it is far better to switch off when not in use, although I have never heard of a BBC bursting into flames.

Mr Smith's computer has one of the old linear power supplies which gets very hot, and he also asks what the signs are of the power supply being overloaded as more and more ROMs and other devices are added that draw on the power from the power supply. The answer is unpredictable behaviour on the part of the computer, or a total failure to work. These could be symptoms of many specific faults, but an overloaded power supply will cause errors to occur in many parts of the computer. If the linear power supply (these are usually black as opposed to the gold colouring of the switched-mode power supplies) gets very hot then it would be wise to have it replaced before it fails and possibly damages the rest of the computer. A local Acorn service agent will be able to do this.

MEMOTECH BBC CBM64 SPECTRUM ORIC1 LYNX NASCOM ATARI

**Trapped in a fiendish Level 9 Adventure?
Your lamp burning low? Every exit guarded?**

You need escape plans! Send for one of Level 9's great new clue sheets for help. The clue sheets are free and each answers hundreds of questions: follow the instructions supplied with your adventure to get one. (Don't forget to send a stamped self-addressed envelope and tell us which game you have.)

NEW REVIEWS: "Level 9 are fast establishing a name for themselves among computer adventurers as the Number 1 producers of quality adventure software. All their adventures are text only, but because of a special coding they have developed, the amount of description and the number of locations packed in 32K is truly amazing."

— Midweek, 10 May 84

"Quicksilva call themselves the 'Game Lords'. That might be open to argument. But there can be no doubt that Pete Austin and the team at Level 9 are the 'Lords of Adventure'."

— Central Press Features, April 84

"Play Lords of Time and get nine times the pleasure!"

— Your Computer, May 84

AVAILABLE FROM: WH Smith and good computer shops nationwide.

If your local dealer doesn't stock Level 9 adventures yet, ask him to contact us or: Centresoft, Drake Distribution, Ferranti & Craig, Hi-Tech, Lime Tree, Microdeal, R&R or Wonderbridge.

Level 9 Computing

- Colossal Adventure:** the original mainframe adventure with 70 extra locations
- Adventure Quest:** an epic journey across the weird landscape of Middle Earth
- Dungeon Adventure:** a truly massive game which completes the Middle Earth Trilogy
- Snowball:** could this be the biggest SF adventure in the world?
- Lords of Time:** an imaginative romp through World History

I ENCLOSE A CHEQUE/PO FOR £9.90 EACH

My name:

My address:

My micro is a:
(one of those listed on the arch above, with at least 32K of memory).

Contact:

LEVEL 9 COMPUTING
Dept. A, 229, Hughenden Road
High Wycombe, Bucks. HP13 5PG
Telephone: (0494) 26871

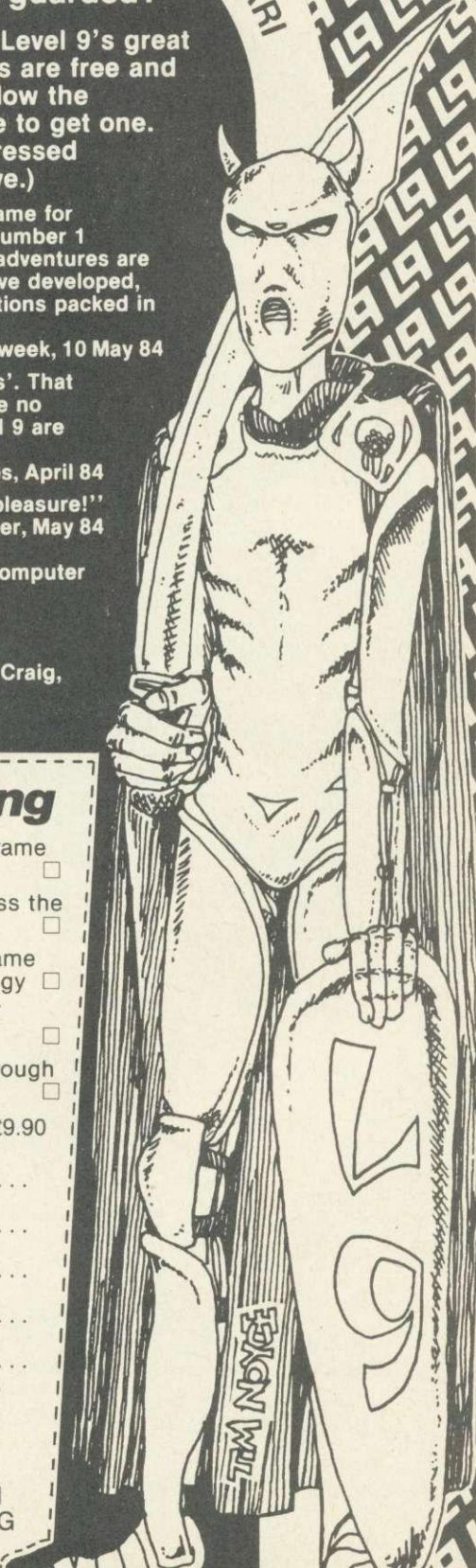
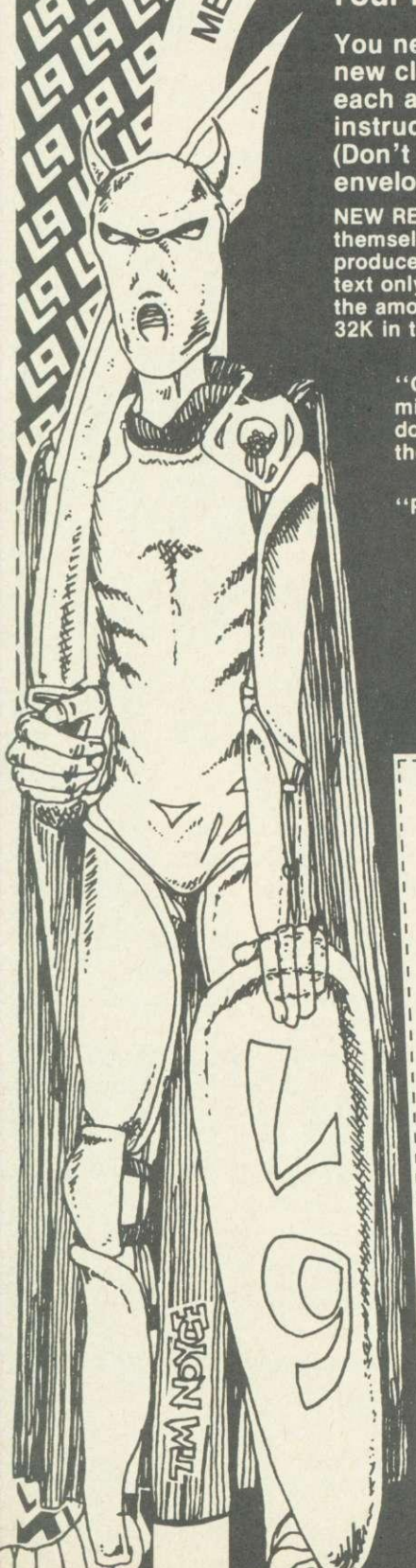

£24.⁹⁵

PRICE BREAKTHROUGH

BBC SPEECH

Speech Synthesizer for the BBC Computer



Price includes V.A.T.,
Postage and Packing.
Delivery normally 14 days
Export orders at no extra cost.
Dealer enquiries welcome
Send cheque/PO now to:-

- Totally unlimited vocabulary is now possible with the revolutionary "SWEET TALKER" Speech Synthesizer for the B.B.C. A or B Microcomputer, any series.
- The CHEETAH "SWEET TALKER" simply plugs into speech socket IC99 within the computer. No soldering, no cutting of tracks, no headaches.
- Based on an allophone system you can easily program any word, sentence or phrase and incorporate speech into your software games.
- Fully tested and guaranteed. Complete with demonstration cassette and full instructions.

Cheetah, products available from branches of

John Menzies **Boots** **WHSMITH** and **Rumbelows**

Cheetah

Marketing



Cheetah Marketing Ltd, Dept. A/U, 24 Ray Street,
London EC1R 3DJ. Tel: 01 833 4909.
Telex: 8954958.

Low Prices

Best Service



- ★ Europe's No. 1 Group of Retail Outlets
- ★ Check our multi-national network for your nearest dealer
- ★ Backed by an after-sales service second to none

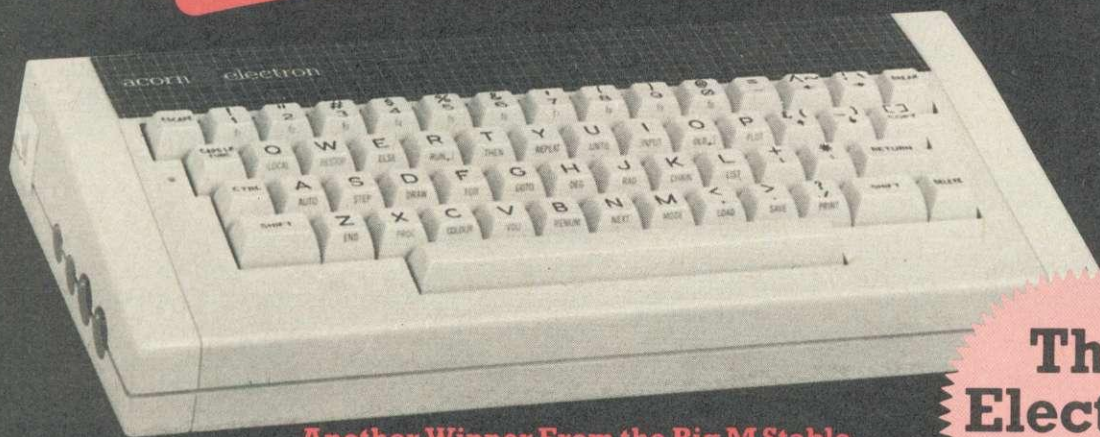

Another Winner From the Big M Stable

The Electron - A thoroughbred from the manufacturers of the BBC, who have incorporated all their experience and knowledge to conceive another winning computer. Many BBC programs are compatible. This full colour 32K ROM and RAM computer with text and graphics includes a cassette input, and a multi-way connector for the addition of expansion units containing interfaces to additional hardware. It has a 56 key full travel QWERTY keyboard, 10 user-definable and 29 pre-defined keys enabling BASIC keywords to be entered in a single keystroke. The Electron comes with free introductory cassette containing 19 programs including a number of exciting games. £199.00

**The
Electron
£199.00**

Low Prices

TORCH Z80 - Disk Pack
800K - £803.85
Dual disk drive with Z80 second processor and CPM for BBC. Gives BBC 64K of usable RAM.



£803.85
TORCH Z80
Disk Pack
800K



£199.00
Commodore
64

COMING SOON
Commodore
Plus-4 £249.00

Commodore
16 Starter Pack
includes Cassette Unit,

Introduction to Basic and 4 Software
Programs for only £129.95

Commodore 64 - £199.00
Colour sophisticated ROM/RAM user, UHF/Composite video, high resolution graphics.

Sinclair ZX
Spectrum
£129.95
48K

Sinclair ZX Spectrum -
48K basic, colour and text graphics. - £129.95



BBC
Model B
£399.00

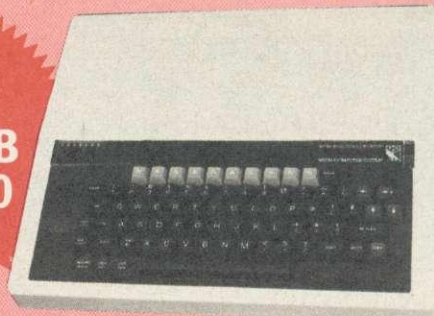

BBC Model B - £399.00
Full colour 32K ROM Computer with text and graphics 80 column text screen, extended Microsoft basic, built in assembler 1MHz and tub interface, sideways ROM RS 423, A/D converter.

MONITORS

RGB Colour Monitor STD/RES £228.85

RGB Colour Monitor H/RES £632.50

12" Green Monitor £99.00 12" Amber Monitor £120.75

RGB
COLOUR
MONITORS
from
£228.85

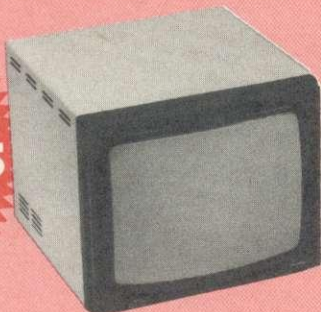

Double Density DFS - £120.00
Disk controller for the BBC Micro. Up to 2MB on line storage. Auto internal format programs for 5 1/4" and 3" drives. Acorn compatible runs basic, wordwise, BCPL, view forth etc. 25% faster than Acorn DFS on file access. Auto 40-80 track switching. Compatible with .1 DFS view and sideways ROM.

Double
Density
DFS
£120.00

The Big International

Bucks

Citybench
2/4 Eaton Place
Marlow
Tel: 06284 75244

Micro Land
Weatherburn Court
Brunel Centre
Bletchley
Milton Keynes
Tel: 0908 368018

Cambridge
G.C.C. Cambridge Ltd
66 High Street
Sawston
Cambridge
Tel: 0223 835330

Cornwall
Computavision
4 Market Street
St Austell
Tel: 0726 5297

Derby

First Byte Computers
10 Castlefields
London Road
Derby
Tel: 0332 365280

Devon
Computer Systems (Torbay)
Pump Street
Brixham
Tel: 08045 6565

Roy Hart
Computer Services
10 Fore Street
Tiverton
Tel: 0884 253468

Dorset

Solent Micro Systems Ltd
25 Bargates
Christchurch
Tel: 0202 470468

Durham

General Northern
Computing
8 Whitworth Road
South West Ind. Estate
Peterlee
Tel: 0783 860314

Essex
Essex Computer Centre
216 Moulsham Street
Chelmsford
Tel: 0245 358702

Focus Computer Systems
140A Hathaway Road
Grays
Tel: 0375 79717

County Computer Stores
5a West Square
Harlow
Tel: 0279 414692

The Home Computer Centre
261 Victoria Avenue
Southend-on-Sea
Tel: 0702 43568

Glouce
The Model Shop
22 High Street
Stroud
Tel: 04536 5920

Sabre Consultants Ltd
103 High Street
Tewkesbury
Tel: 0684 298866

Herts

County Computer Stores
95a South Street
Bishops Stortford
Tel: 0279 506801/2

Hobbyte
153 Grove Road
Harpندن
Tel: 0587 3542

N. Humberside

Beverley Computer Centre
1 Windmill Passage
55 Lairgate
Beverley
Tel: 0482 881911

S. Humberside
Ashby Computer Centre
186 Ashby High Street
Scunthorpe
Tel: 0724 871756

Kent

Tollgate Computers
249 Beaver Road
Ashford
Tel: 0233 37187

Data Store
6 Chatterton Road
Bromley
Tel: 01 460 8991

Canterbury Software Centre
9 The Friars
Canterbury
Tel: 0227 53531

North Kent
Computer Centre
52/54 Bellgrove Road
Welling
Bedley
Tel: 01-301 2677

Lancs

Amat Computing
67 Friars Gate
Preston
Tel: 0772 561952

London

Henry's Computer Shop
404 Edgware Road
London
Tel: 01 402 6822

Miracle Computers
245a Coldharbour Lane
London
Tel: 01 274 7700

Greater Manchester
Entertainment in Leisure
88 The Rock
Bury
Tel: 061 797 3463

Control Technology
184 Market Street
Hyde
Tel: 061 366 8223

Middlesex

Enfield Communications
135 High Street
Ponders End
Enfield
Tel: 01 805 7772/7434

Wiltshire
Regina
Wuthall
Tel: 01 52

Windsor
Windsor
Tel: 0895

Wiltshire
Wiltshire
Tel: 0203

Wiltshire
Wiltshire
Tel: 0902

Best Service

DISK DRIVES
from
£201.25



ACORN AND BBC DISK DRIVES
Disk Drive 100K Single £201.25
Disk Drive 200K Single £241.50
Disk Drive 400K Single £396.75
Disk Drive 800K Dual £711.85

Two New Products from QUEN-DATA



DWP 20 Daisy Wheel Printer ONLY £299.00



Executive 80 Electronic Office Typewriter With 2 Line display ONLY £459.00

PRINTERS
Astron JP80 (as ill.) £199.00
MCP40 (Colour Printer) £171.35
Epson RX-80 Printer £314.00
Epson FX-80 Printer 160cps £399.00

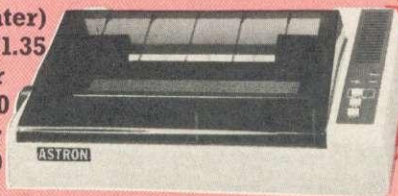

PRINTERS from £171.35

Joystick & Cassette Players



Joystick & Cassette Players - Many joysticks and cassette players available from stock. Just in . . . The BBC Compatible Crack-Shot. £10.95

SOFTWARE

all leading chart software available



This special complete pack contains:
Apple IIe Personal Computer, disk drive and controller. TV Modulator (colour and sound) • £25 Apple Software rebate certificates
£100 Training Voucher • £25 Apple Monitor rebate certificate • Micronet/Prestel discount voucher - £68 off • 'Windfall' Apple user magazine
Apple Sports Bag • Software Certificates • Catalogue of Hardware and Software £999.

APPLE HOME PACK £999



National Dealer Network

Hullar Computers
Regina Road
Southall
Tel: 01 574 5271

Norfolk
Abacus
12a Pottersgate
Norwich
Tel: 0603 61441

Town Computer Store
30 Town Road
Hanley
Stoke-on-Trent
Tel: 0782 287540

E. Sussex
Gamer
24 Gloucester Road
Brighton
Tel: 0273 698424

Tyne & Wear
Video & Home
Computers Centre
3 Roxburgh House
Park Avenue
Whitley Bay
Tel: 0632 534725

Wales
Automation Services
42 Dunraven Place
Bridgend
Mid Glamorgan
Tel: 0656 3550

For your nearest European Dealer telephone Belgium or Holland

L.L. Computers
Windsor Street
Abridge
Tel: 0895 51815

Viking Computers
Ardney Rise
Catton Grove Road
Norwich
Tel: 0603 45209

Suffolk
Brainwave
24 Crown Street
Ipswich
Tel: 0473 50965

W. Sussex
Bits & Bytes
High Street
Bognor Regis
Tel: 0243 867143

N. Yorkshire
Skipton Computer Systems
16 Swadford Street
Skipton
Tel: 0756 68192

Scotland
Micro Store
38 The Arcade
King Street
Stirling
Central Region
Tel: 0786 64571

Belgium

Micro Management
Belgium
Ballaerstraat 75
2018 Antwerp
Belgium
02-238 9284

Midlands
Sinewave Computer World
Hartford Street
Coventry
Tel: 0203 27711

Somerset
Sinewave Computer Services
Corporation Street
Taunton
Tel: 0823 57526

Micro Management
32 Princes Street
Ipswich
Tel: 0473 59181

Orchard Business Systems Ltd
34 East Street
Horsham
Tel: 0403 68461

W. Yorkshire
Thoughts & Crosses
37 Market Street
Heckmondwike
Tel: 0924 402 337

Holland

Micro Management
Nederlands
Raad Huisstraat 98 2406
Ah Alphen-aan-den-rijn
01720-72580

Overhampton Compu
Centre
19 Lichfield Street
Overhampton
Tel: 0902 29907

Staffs
Eric Reynolds Ltd
86 High Street
Burton-on-Trent
Tel: 0283 65086/65869

Surrey
Concise Computer Consultants Ltd
1 Carlton Road
S. Croydon
Tel: 01 681 6842

Worthing Comp. Centre
32 Liverpool Road
Worthing
Tel: 0903 210861

N. Ireland
Everyman Computers
80 Charlotte Street
Ballymoney Co Antrim
Tel: 02656 62116/62658

CARE ELECTRONICS

UNIT 14, PEERGLow INDUSTRIAL ESTATE, OLD'S APPROACH, TOLPITS LANE, RICKMANSWORTH, HERTS.
 ☎ TELEPHONE: 0923 777155 ☎

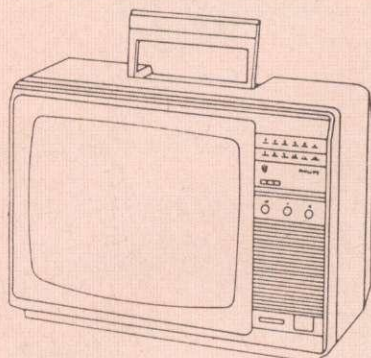

DON'T BUY A COLOUR MONITOR!!

HAVE YOUR PHILIPS 14" COLOUR TV CONVERTED TO A TV/MONITOR

"ONLY" £49.95 each inc VAT.

- * Image clarity comparable to leading monitors.
- * Includes RGB lead for connecting with BBC.
- * Conversions carried out at our workshops within 2/3 days.
- * 3 Months Guarantee.

"VIGLEN" TEAC 55 SLIMLINE DRIVES:

	Inc VAT	Ex VAT
SINGLE DRIVES CASED		
40 Track 100K	@ 143.75	125.00
40 Track 200K	@ 195.00	169.56
40/80 Track Switchable 200K	@ 179.00	155.65
40/80 Track Switchable 400K	@ 225.00	195.65
DUAL DRIVES CASED		
40 Track 200K	@ 287.50	249.57
40/80 Track Switchable 400K	@ 358.00	311.30
40/80 Track Switchable 800K	@ 450.00	391.30

"VIGLEN" TEC DRIVES: (As used by Cumana)

	Inc VAT	Ex VAT
SINGLE DRIVES CASED		
40 Track 100K	@ 129.00	112.17
40/80 Track Switchable 200K	@ 169.00	146.95
40/80 Track Switchable 400K	@ 209.00	181.74
DUAL DRIVES CASED		
40 Track 200K	@ 258.00	224.34
40/80 Track Switchable 400K	@ 338.00	293.90
40/80 Track Switchable 800K	@ 418.00	363.48

INTEGRAL POWER SUPPLY:

Fitted to any of the above drives	@ 30.00	26.00
-----------------------------------	---------	-------

FLOPPY DISCS:

	Inc VAT	Ex VAT
(Boxes of Ten)		
Fuji D/Sided D/Density 5.25"	@ 27.50	23.95
Maxell S/Sided D/Density 5.25" 40T	@ 15.00	13.04
Maxell D/Sided D/Density 5.25" 40T	@ 23.00	20.00
Maxell S/Sided D/Density 5.25" 80T	@ 20.00	17.39
Maxell D/Sided D/Density 5.25" 80T	@ 30.00	26.09

When ordering Dual Drives, please state which layout you prefer, A or B

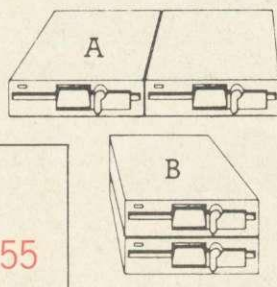

Full Twelve Months Guarantee

CARE ELECTRONICS
 TEL: 0923 777155

"VIGLEN" ROM CARTRIDGE SYSTEM BBC B: (As advertised in August issue)

Complete Set	@ 19.95 inc VAT.
Spare Cartridge	@ 6.95 inc VAT.
5 Cartridges	@ 27.75 inc VAT.
10 Cartridges	@ 49.50 inc VAT.

LEADS "READY-MADE":

	Inc VAT	Ex VAT
6 pin DIN to 6 pin DIN plug (RGB) 1.5mt	@ 2.55 each	
6 pin DIN to 6 pin DIN plug (RGB) 2mt	@ 2.95 each	
6 pin DIN to 6 pin DIN plug (RGB) coiled cable	@ 5.95 each	
6 pin DIN plug to 6 pin DIN skt (RGB) extension	@ 2.55 each	
BBC Power 6 way to Disc Drive 4 way 1.5mt	@ 2.95 each	
BBC Power 6 way to Disc Drive 4 way 2mt	@ 3.55 each	
BBC Power 6 way to 2 Disc Drive 4 way 1.5mt	@ 3.75 each	
Monitor lead BNC to PHONO 1.2mt	@ 2.95 each	
Monitor lead TV to PHONO 1.2mt	@ 2.55 each	

RIBBON LEADS:

Disc Drive single	1.2mt	@ 5.95 each
Disc Drive dual	1.2mt	@ 8.95 each
Printer	1mt	@ 6.95 each
Printer	1.5mt	@ 9.65 each

CONNECTORS:

	Inc VAT	Ex VAT
BBC Power 6 way housing	@ 0.30	Sockets: 0.35 each
BBC Crimp Terminals	@ 0.07	0.08 each
Disc Drive 4 way housing	@ 0.25	0.21 each
Disc Drive Crimp Terminals	@ 0.09	0.08 each
5 pin DIN free 45 degree	@ 0.34	0.40 each
5 pin DIN free 60 degree	@ 0.36	0.42 each
5 pin DIN Chassis 45 degree	@ 0.34	0.40 each
5 pin DIN Chassis 60 degree	@ 0.34	0.40 each
6 pin DIN free (RGB)	@ 0.34	0.45 each
6 pin DIN Chassis (RGB)	@ —	0.45 each
7 pin DIN free	@ 0.35	— each
7 pin DIN Chassis	@ —	0.48 each

DISC INTERFACE PARTS:

E'Prom HITACHI HN482764G	@ 8.00 each
Low power Schottky 74LS10	@ 0.42 each
Low power Schottky 74LS38	@ 0.42 each
Low power Schottky 74LS123	@ 1.05 each
Low power Schottky 74LS393	@ 1.24 each
C'Mos 4013BCP	@ 0.61 each
C'Mos 4020BCP	@ 0.87 each

HOW TO ORDER:

By Post. Enclose your Cheque/P.O. made payable to:
CARE Electronics.
 Or use your ACCESS. Allow 7 days for delivery. Please add carriage.
 Disc Drives @ £8.00 Other Products @ £3.00.



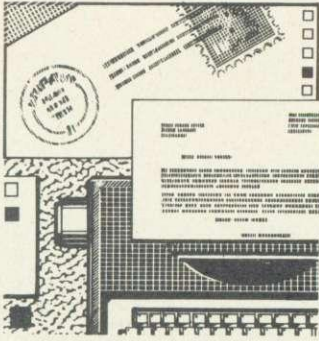

How I became

an expert

in piracy

Sir, Concerning your recent letters on software piracy, I felt compelled to write to you. I am a 15-year-old schoolboy who has a BBC and disc drive. To begin with, I had no professionally produced software at all. Then a friend lent me a tape containing Acornsoft's *Defender* (now *Planetoid*, of course), *Snapper*, *Monsters*, and Bug-Byte's *Space Pirates*. I enjoyed playing these, but then had to give the tape back. I had no knowledge of tape-copying so I had to do without them.

I thought so much of *Defender* that I ordered it from Acornsoft and was very happy with it. I then learnt the basics of tape-copying, which, believe it or not, I heard a computer games magazine reviewer mention at a computer show. He said he pirated

any game he reviewed! I bought a few more games every so often, and then received a disc drive, when I found none of the games would work on disc. I picked up the tape-to-disc techniques and now I am fairly proficient in tape-disc transfer. Funnily enough, the clever tape protection I meet doesn't stop me copying the tape, it merely makes it difficult to get onto disc!

If you think about it, as long as there are people who want software, the industry will survive. After all, if there are no new games to copy, everyone, pirates included, will want to buy some new games, and so a company would spring up to satisfy the demand.

As long as companies push out second-rate software I will not hesitate to copy programs. Also, it is a fascinating pastime to break protection (well, I think so).

Anyway, I have spent £150 on games in all. I have been satisfied with all Acornsoft (six tapes, one disc) and Program Power (two tapes) I have bought, but that is all. I have around 200 plus games programs now, of which very few are any good at all. I probably would have spent even more money on poor games if I had not learnt about tape-copying. I have spent £70 on ROMs and have been pleased with those, although I have many pirated ROMs.

Anon

It's quite a joke in Oz

Sir, It is quite amusing – no, no I'll have to say hilarious – to read the complaint letters from your English resident readers on the subject of software prices and piracy. Oh yes, we really are laughing, I can tell you!

No seriously, it is quite a joke here in Oz (that's short for Australia), you guys always complaining about paying £8 or £9 for the average games software; and *Wordwise* or *View* ROMs for mere pittance of £32.

I just thought I'd clear the air down there in Pommie Land by telling ya's all that up here we pay about £25 for things like Pacman, space invaders and sliding puzzles (all Acornsoft, of course), and about £70 for excellent (but not worth it) products like *View*. Even the computer itself costs about £800 for a model A, while Epson FX80 printers (at least, I

think they're FX80s!) cost about £600, and for some reason the average daisy-wheel printer costs about £650.

So much for 6502 second processors, modems and Bitstik graphics programs! Often the only way to get any programs at all is by resorting to that bugbear of all software manufacturers, piracy.

So if you guys think you've got problems, ha, ha, ha. Say, how about some of you English software firms like Program Power, or Superior Software, or anybody – please – trying to break this damnable monopoly over here and bring in some rationality to the not insubstantial Australian computer market. At the very least, you're bound to make a fortune!

Tim Parsons
Hobart, Tasmania

Protection: the

big challenge

Sir, I am a pirate, and have long been one. I regard any new development in protection as an intellectual challenge, and I haven't failed yet.

With regard to 'self-destruct' devices to prevent copying of EPROMs, how then will it know when to self-destruct if it cannot distinguish between the CPU accessing it to execute the program within it, and accessing it to copy it?

Having said all this, I do make some defence. I don't sell the software I pirate, I merely copy it for my own and my friends' use – and most of it doesn't get used. Most of the games sold are not worth the disc space required to keep them. The prices charged, especially by some companies, for sloppily coded, badly packaged rubbish are extortionate in the extreme, and, after buying three games since receiving my BBC, I vowed never again to buy a piece of software.

To close, I would like to say to all software houses: get your act together, bring out some decent software for a reasonable price, instead of wasting money on developing ineffective 'anti-copying' devices, and I might just change my mind.

Anon
Gwynedd

For a tidier

key strip

Sir, I should like to offer a small improvement to the function key strip program written by Andrew Britton (July issue, yellow page 1). I have made a slight change to line 330 so that the text is centred within the boxes.

The additions are as follows:

```
330 FORN% = 1TO10:READ
      INSERT MODE      DEFAULT
      HIGHLIGHT 1      HIGHLIGHT 2
      BEGINNING OF LINE  END OF LINE
```

Detail of the key strip

```
A$:1 = INT((n-LEN(A$))/2)
335 PRINT "!";SPC(1);
A$:SPC(n-(LEN(A$)+1));
NEXT:PRINT"!"
```

I hope users will make what is already an excellent and useful little program a little more pleasing.

K Stephenson
Cumbria

Copying ROM

Sir, In reply to G Dubber (June issue), the introduction of sideways RAM boards may be seen as a threat by manufacturers of ROMed software, but they would be foolish to follow his advice.

I bought my sideways RAM as an extremely versatile alternative to a normal sideways ROM board and I would be less than delighted if my investment were rendered useless for future ROMs. Since most ROMed programs tend to be duplicated by other software houses (lots of wordprocessors and databases to choose from) I will buy those that allow me to use my program as I see fit – after all it is my program unless I try to sell it illegally.

P Faskett
Liverpool

Offensive weapon

Sir, Have you noticed the unsubtle advertising for educational software on the BBC micro? At the top of one catalogue there is a *gun*.

Is this a symbol that should be associated with teaching? Children are readily influenced by what they see on computers and there are enough zap and kill games already. There is no need to bring weapons into the education environment.

M Richards
(Teacher)
Sussex

The source

Sir, I have solved 90 per cent of the software piracy problem on 8-bit based micros. Ninety per cent of programs do not use overlays, and therefore exist completely within the 64k addressable by the 8-bit microprocessor. Now each bit (there are 64x1024x8 bits available) can be set either to 0 or 1. There are therefore 2 to the power 64x1024x8 possible

Half a box is better than one?

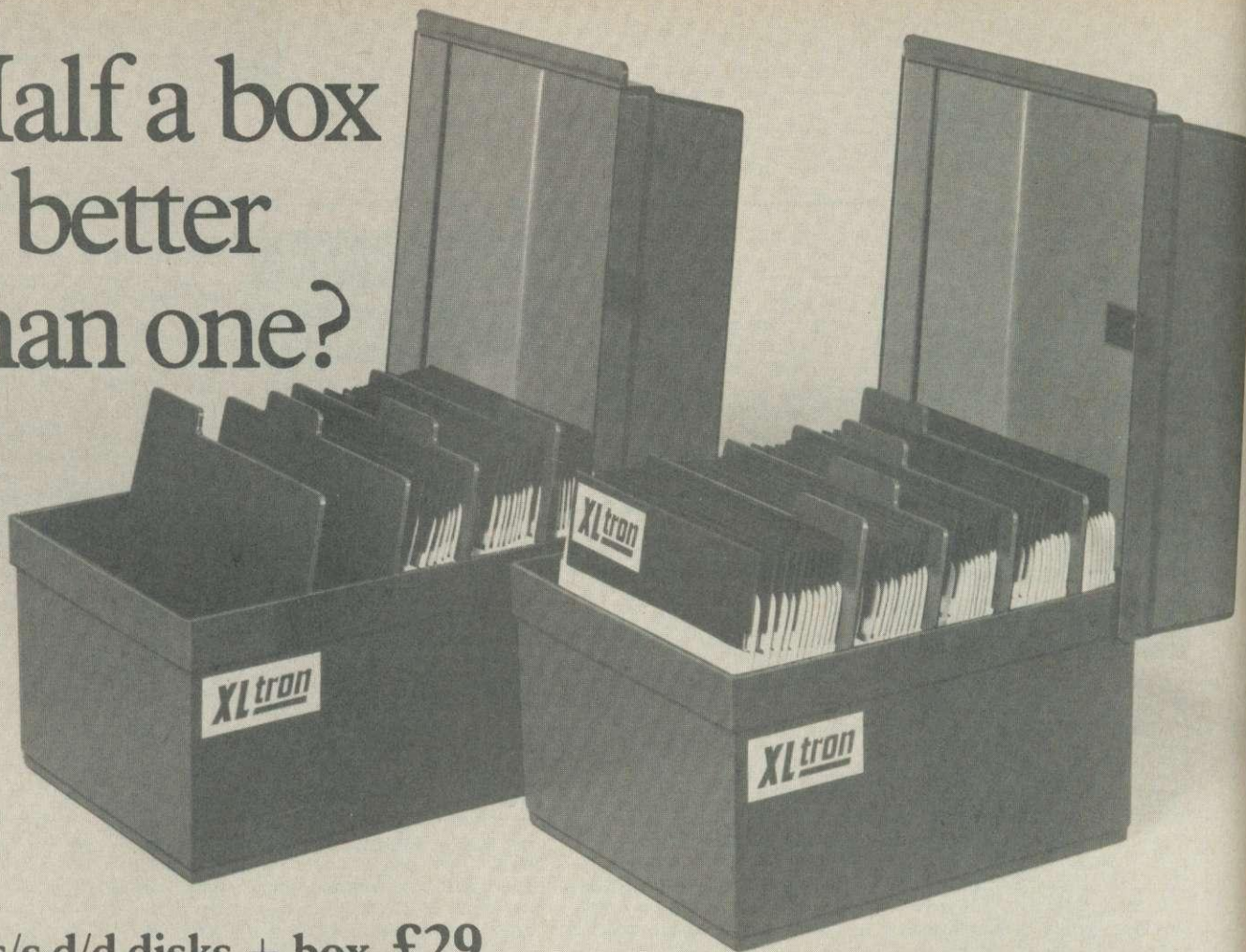

25 s/s d/d disks + box £29
plus VAT and P + P
25 d/s d/d disks + box £39
plus VAT and P + P

50 s/s d/d disks + box £50
plus VAT and P + P
50 d/s d/d disks + box £75
plus VAT and P + P

We ran the advertisement opposite to move some stock left from a cancelled order. And move them it certainly did. We're still selling around 30 boxes a day, that's over 30,000 disks a month. So we bought some more, and are going to continue selling at the same price.

We also got a lot of people on the phone asking if we could supply slightly fewer disks, and as you see, we're now offering boxes in 25's as well.

Every order of 25 or 50 comes packed in the same rigid plastic storage box with four dividers, we've kept the same high specification and all disks carry our two for one guarantee.

To order, just clip the coupon below. Personal callers welcome.

We accept orders from all government bodies, schools, universities, libraries, armed forces etc. We despatch on receipt of an official purchase order. If you can't raise a cheque without an invoice please post or telephone your order and we'll send you a proforma by return.

Disco Technology Limited, Lex House, 3/6 Alfred Place, London WC1, England. Telephone 01-631 0255,

- Please rush me
- (qty) storage box(es) filled with 50 s/sided disks at £59.50 each.
 - (qty) storage box(es) filled with 50 d/sided disks at £87.25 each.
 - (qty) storage box(es) filled with 25 s/sided disks at £33.65 each.
 - (qty) storage box(es) filled with 25 d/sided disks at £47.15 each.
 - (qty) empty storage box(es) at £11.

Prices include VAT and P + P. I enclose cheque for _____ or debit my Access card no. _____

Name _____ Signature _____

Address _____

Postcode _____ Telephone _____

To: Disco Technology Ltd, Lex House, 3/6 Alfred Place, London WC1.

Take Advantage of us!

50 s/s d/d disks + box - £50 plus VAT + p&p
50 d/s d/d disks + box - £75 plus VAT + p&p

Disco-tek sells disks and accessories, we'll sell them to practically anyone, anywhere. So when we get a telephone order for a lot of storage boxes and disks we don't waste any time and stocked up. Then the order was cancelled. So we're having to let them go at cost, in fact, less than cost.

For just £50 we can supply a rigid, high impact plastic storage box, with four dividers packed with 50 single-sided, double-density disks. The same storage box filled with 50 double-sided, double density disks will cost just £75. And all carrying our five year guarantee - if a disk is faulty send it back for two free replacements.

To order just clip the coupon below.

To Disco-Technology Ltd,
20 Orange Street,
London WC2H 7ED

Please rush me _____ qty storage boxes filled with 50 single-sided
50 double-sided disks at £59.50 or £87.25 respectively,
or debit my Access card No. _____ I enclose a cheque for £ _____

Name _____ Signature _____
Address _____
Postcode _____ Telephone _____

To Disco-Technology Ltd,
20 Orange Street,
London WC2H 7ED
DISCO-TEK

© Certain Advertising Ltd 01-930 7612

XLtron

```

10 REM Freak Out by R. Newman
20 FOR X=200 TO 800 STEP 23
30 FOR Y=200 TO 800 STEP 17
40 SOUND1,-15,X*Y,1
50 NEXT Y,X
    
```

Listing 1. Robin Newman's noisy demonstration of nested loops

combinations, and these must include every program that can ever be written for any 8-bit microprocessor.

My micro is currently acting as a program generator, listing all the possible combinations, and therefore I will soon possess the copyright on all programs not yet written. I am following standard micro-computer business practice in that I am announcing these programs slightly before they are finished, and most of them will eventually prove to be useless rubbish, nevertheless they are *mine, all mine*.

The solution to the piracy problem is that I hereby give my permission for anybody to copy any of my programs so produced.

G Swain
Berks

Secrets of the floating point

Sir, I have a number of large programs half-written for my BBC model B but they must all be converted to machine-code as they are far too slow in Basic, however well written. The problem is that they all require floating-point mathematical functions that are in the Basic ROM.

I wrote to Acorn asking for the addresses of these routines and how to use them but they said that there was no data sheet available on either Basic ROM. Commodore supplied the equivalent information on its Vic-20 for Nick Hampshire's *Vic Revealed*, as did Sinclair for Toni Baker's *Mastering Machine-Code on Your ZX81 or ZX80* so I see no reason for Acorn to withhold this for the BBC micro.

I could write routines for multiplication and division of floating-point numbers but these would be useless without the trig and log routines.

I am therefore writing to you, asking if either you or any of your readers can help both myself and, I am sure, many other people, with this problem.

Neil Howard
Herts

Breaking point

Sir, In the July *Acorn User* a reference is made to using CALL !-4 as a software substitute for pushing the BREAK key. This should be used with care, as it can have unwanted side-effects, since the BREAK key also provides hardware resets to certain chips in the Beeb besides the 6502 microprocessor. Often there will be no discernible difference, but it is advisable to disable the NMI system by setting &D00 to &40 (RTI) immediately before making this call to prevent the disc or Econet from crashing the system.

Also, users with Econet and the new DNFS ROM will find that Econet disappears completely if you type CALL!-4. This is because the ROM checks that the Econet 68B54 exists in a reset state when it initialises, and if it doesn't then it switches out the Econet half of the ROM! This is so that the ROM can be used on disc-only machines.

Both these precautions are contained in the following code, which I have found to work satisfactorily without problems:

```

.break LDA#&40:STA&D00:
LDA#&C0:STA&FEA0:
JMP(&FFFC)
    
```

Storing &C0 in &FEA0 initialises the Econet so that DNFS still thinks it's there!

On a completely different tack, the sound effects on Yellow Pages XVI of the July issue reminded me of a very simple yet effective program that I use when teaching about nested FOR . . . NEXT loops (listing 1). It speaks for itself, lasting about 48 seconds. It is worth pointing out that the step sizes should both be prime numbers for maximum variety.

Robin Newman
Peterborough

Better chess

Sir, In the March 1983 *Acorn User* there was a review of three different chess programs by Computer Concepts,

<i>Mate in two moves (three-ply)</i>	
New version	1 min 41 secs
—correct	
Old version	22 secs
—correct	

<i>Mate in two moves (three-ply)</i>	
New version	59 secs
—correct	
Old version	18 secs
—incorrect	

<i>Mate in three moves (five-ply)</i>	
New version	27 mins 38 secs
—correct	
Old version	test not given
Program Power Chess	49 mins
—correct	
Acornsoft Chess	35 mins
—correct	
White Knight	15 secs
—correct	

Program Power and Bug-Byte. Computer Concept's *Chess* was the earlier version 2.32 C1 but there is a new version 2.32/1 E/A, which provides a few more facilities.

I decided to put this new program through some of the tests that the other programs were put through. The results are

recorded above:

The new version is much improved, allowing a Blitz game to be played and OS commands to be entered during the program. I have been very satisfied with this program and I would recommend it.

Duncan Miles
Kent

Computers in adult literacy

Sir, Jonathan Read's article on computer applications in adult literacy (*Acorn User*, June) not only reflects how far behind the primary sector we are in terms of software experience, it also highlights the lack of fluent dialogue between Adult Basic Education tutors and software designers.

A root cause of this impoverished state of affairs is the patchy nature of computer-related inservice training funding for ABE, but then it could be argued that there is no cohesive demand from the scattered full (but mainly part-time) ranks of professional (mainly women) tutors plus the hidden army of volunteers. Furthermore, it does not make for good economics in terms of college survival to cater for the Have Nots.

Jonathan Read might benefit from being made aware of the qualitative non-didactic methodology of the many ABE tutors, whose primary resource for materials acquisition lies in the students' own vocabulary rather than books *per se*. Some excellent examples of print-based materials along these lines can be found at the Gaddum Centre, Deansgate, Manchester.

His statement 'The students waste a lot of time trying to hide their ignorance from the tutor and themselves' and also that it is 'no help to the students to be given work that they already know since they

are bound to get it right' suggests that he may also benefit from an appreciation of ABE training methods in student/tutor relationships and confidence-building techniques.

To state that the computer has more of the human qualities of patience than an ABE tutor and more flexibility may be a little misleading and may not inspire ABE tutors to warm to their use. It may be more helpful for tutors to find out how the computer can be a powerful *optional* resource rather than a teaching machine (as implied by Jonathan Read), that may do many of them out of the few part-time hours they are grimly hanging on to.

There is always a place for specific drill and practice programs like flashcards, in spite of comments like 'paper flash-card are 10 a penny. What use a computer?' However, some ABE tutors might like to see a new generation of programs which allow greater creative control of the text by the students, while others might be interested in group problem-solving activities that are life skills related. Whatever the case, there is much that can be learned from the primary sector, whose software I am familiar with, provided an adult context is adopted.

Eileen Fawcett
Secretary, Computers in Adult
Basic Education
15 Berbice Road
Liverpool L18 0HU

ASK a silly question, pass a fair comment, stage an angry protest — we don't mind what you write to us about (or about us!). Keep 'em short, keep 'em sweet, but keep 'em coming! The address is: Letters, Acorn User, Redwood Publishing, 68 Long Acre, London WC2E 9JH.

The Incredible HULK (£25 + VAT)

HULK is the poor man's knowledge engineer. Knowledge engineering is the new approach to software design which underlies the dramatic success of recent expert systems.

The HULK package (so called because it Helps Uncover Latent Knowledge) offers users of the BBC and Torch microcomputers a low-cost route into knowledge engineering. It will enable you to build up and test a set of decision rules which can be used for prediction or classification. Thus HULK takes the donkey work out of developing a 'knowledge base'.

This is what the Practical Computing software review said about HULK:

"It is very quick and interactive and justifies its name - it does help uncover latent knowledge."

"It can genuinely help people to make sound decisions - and bad decisions are extremely costly in many enterprises." (March 1984 issue).

HULK is available at £28.75 including VAT for BBC/B (preferably with disks) or Torch microcomputers. We will also make it available for the QL as soon as Uncle Clive lets us have one! Cheque/PO with order form:

Warm Boot Limited
40 Bowling Green Lane
London EC1R 0NE (01-278 0333).

[We can also supply xForth at £65 + VAT and BDS C Compiler at £110 + VAT in Torch disc format.]



MICRO
**EXTERNAL
SIDEWAYS ROM
EXPANSION**

- *Sideways ROM expansion to 16 ROM's, all sockets software addressable.
- *Unique two circuit board design requiring the minimum amount of space within the computer.
- *System can be purchased for EXTERNAL or INTERNAL use with the BBC micro.
- *External board mounted in a smart open based purpose built box, colour matched to the BBC micro.
- *NO soldering, plug in design.
- *Plugs into the CPU socket using IC socket compatible pinouts.
- *Full instructions provided.
- *Buffered minimising the loading on the computers internal circuitry.
- *Minimal power consumption when board fully populated.
- *Fully compatible with all ROM's/EPROM's.

AVAILABLE SOON (on external system):
RAM Expansion module. Combined EPROM eraser/
programmer module. Further ROM expansion modules.

PRICE (inclusive): External system £59.95 + £2 p & p
Internal system £47.95 + £1 p & p

PAYMENT: Send your remittance (cheques/PO only please)
with your order to:

MICRO-Z LTD.
P.O. Box 83, Exeter, Devon EX4 7AF
S.A.E. for full details.

SPECIAL REDUCTION
DISC DRIVES FOR £129.95
BBC COMPUTERS

IBM
Approved
Supplier

IBM Authorised Dealer

BBC
MICRO COMPUTER

ACORN
COMPUTER

IN STOCK
**6502 + Z80 SECOND
PROCESSOR · BITSTIK**

**WE ARE SPECIALISTS - WITH
OVER 400 ITEMS JUST FOR
BBC/ELECTRON ON
OUR PRICE LIST**

PHONE
BURGESS HILL
(04446)

45636

Ask about our Maintenance Agreement



michael
Business Systems Ltd

195 LONDON ROAD BURGESS HILL SUSSEX

BBC 32k Electron Imaginative educational programmes from **LEARN WELL**

DISCOVERY

An educational game to develop language skills in context. Discover the concealed answer (up to 255 characters long) to a question by either buying letters of the alphabet from your Jackpot or inserting words. Using the question and answer format children and adults learn words and spellings in context. This programme is flexible enough to cope with any language level or to cover any topic area, and will be an invaluable aid either in the classroom or at home. Already used in schools throughout the country.

Ideal for group or individual use for anyone over the age of seven.
Full instructions supplied. **Cassette price £9.50 inc.**

SHAPE

Children distinguish between shapes and sizes as they create stunning full colour designs or pictures directly through the keyboard. Creations can be constructed using circles, squares and triangles or from using three thicknesses of line. Text also available. You may save your masterpieces on tape when you have finished. No expensive extras to buy.

Full instructions supplied. **Cassette price £8.00 inc.**

ZARGON

Defend the city against the Zargon attack.
A letter recognition/keyboard trainer which gets faster as you get faster.
9 levels of difficulty. Superb graphics. **Cassette price £4.99 inc.**

I-SPY

(A game for two players)
A combination of I-Spy and Snakes and Ladders, you take it in turn to guess the word the computer is thinking of from the sound blend clues. Get the answer right and you move up the board. Land on a diamond and up you go again. If you get the answer wrong don't worry, you will be given more clues. Contains 180 graded words. Colour and soft-sounds.

Value at only £4.99 inc.

CRUISER

A number equaliser that teaches the concept of addition and subtraction as children play. Add or subtract from a number to line up on a target.
Nice graphics and sound. 2 levels of difficulty. **Value at £4.99 inc.**

SUM UP

10 level of integer arithmetic (+, -, ×, ÷) laid out in conventional form.
Realistic rewards. **Cassette price £4.00 inc.**

**ALL PROGRAMMES DEVELOPED AND
TESTED IN CLASSROOMS**

Available now from

LEARN WELL

152 Westmorland Road, Wyken, Coventry CV2 5BU

Please send details of your machine with cheques, P.O.'s etc.

BBC 32k

Electron

Activity board

adjustments

Sir, I have discovered a few inconsistencies between listing 1 and the text in my article on the activity board project (August issue).

The final paragraph (page 113) should read as follows:

To change the sentences to fit a new situation, change the data lines 710 to 790. Type your new title on line 710, followed by your eight new sentences. One important point—because of the double-height letters, the sentence must not be longer than one line. If you want single-height letters type line 510 as follows:

510 PRINT B\$(J)

and line 580 as follows:

580 PRINT D\$(K)

and leave out line 590.

In addition, the program analysis is one line behind the listing from line 130 to 520 and two lines behind from line 530 to the end.

Susan Kingsbury
Norfolk

Brother's buffer

a puff?

Sir, I enjoyed the On-line Type-writer review in the July issue but I was amused to see that Barry Pickles has also been taken in by the claims of the advertisers of the Brother EP44 that is 3.5k text buffer is sufficient for 'about three pages of A4'. Of course it is not. It gives only about one paragraph overleaf from one page of A4 single-spaced text, and it is highly misleading of Brother to suggest otherwise. One line of average text on A4 takes about 60 characters, even leaving a generous left and right margin, and 60 lines of text falls well within the length of an A4 page.

Apart from this major discrepancy, which should be brought to the attention of the Advertising Standards people, I find the machine lives up well to the claims and reviews. Certainly the print quality is a great improvement on that of the EP22 and 20. But then look at the extra cost!

J Watson
Herts

Kitty untangles

some of the

jargon for two

confused readers

Q I must say I find my new BBC B plus disc drive a bit bewildering. It is all very well to be told to print " \$ " ; , . - / . But what I want to know is why these extraordinary symbols are chosen and to do what exactly—will I ever get to know? How do you write a program if you don't know what CHR\$ is actually doing?

Charles Berridge
Sussex

A Yes, the symbols used in many Basic programs can indeed be very confusing and seem to have been an odd choice. The history behind them is simply that the first real computers were American and they used the standard American qwerty typewriter keyboards: they have \$ instead of £, for example. Really, it's all quite arbitrary—you just have to accept and memorise each symbol and what it does.

The various unfamiliar symbols just act as a code to the computer. The asterisk (*) usually signifies multiplication but when used in front of a word means that that word is not a Basic command, but an operating system command. So any word with "*" in front of it is dealt with by the operating system chip instead of the Basic chip. The slash (/), means divide.

There are two kinds of variables in Basic: number and string. Number variables contain only numbers, whereas string variables contain letters, symbols or whole words. The Beeb stores the two kinds in different places and so needs to be able to find them again easily—this is where the \$ sign comes in. The \$ is used to define a variable that is to hold a series of characters rather than a number, eg, A\$="Charles".

Quotes are used to enclose the characters so that they appear on the screen rather than being acted on inside the Beeb. The full stop is used to



denote a decimal point in a number, while the comma merely separates items in a list. A semi-colon is used in several ways: in a PRINT statement, for example, it ensures that text is printed on a single line, thus avoiding a carriage return.

Finally, the colon is used to separate several commands in a single line, thus telling the computer where its end and start is. Look through any listings in this issue and these definitions should become much clearer.

CHR\$ is the computer shorthand for 'the character with the code number ...'. So PRINT CHR\$(69) means: print on the screen the character with the code number 69—in this case a capital E. You could do the same with PRINT"E", so why bother? Well, some characters don't have a key on the keyboard—graphics characters, for instance—and here the only way of referring to them is by CHR\$ and their code number (a list of code numbers is given in the BBC *User Guide*).

Q I have great difficulty in understanding what sideways ROMs and RAMs, second processors and ROM extension boards are and how they affect the workings of the 'standard' system.

Could you point me towards a book or article that might clear up some of my confusion. I have only recently started reading *Acorn User*—perhaps a back number is available which does this.

Andrew Sims
Glasgow

A Perhaps the biggest barrier in the path of anyone breaking into the world of computing is the jargon. The computer world is full of it; however, as in most specialities, the terms

are quite easily understood. RAM and ROM are mnemonic terms that denote different types of memory on a computer. ROM (Read Only Memory) is a permanent memory—its contents are always available when the computer is on and cannot be changed from the keyboard; RAM (Random Access Memory) is more volatile and when the computer is turned off its contents are gone for ever—unless you've stored them on disc or tape first. The programs you enter are placed in RAM.

The BBC micro can have several chunks of RAM or ROM physically sitting side by side on the circuit board, but with only one in use at any one time (except the operating system—that is permanently on). By using certain commands (for example, "WORD" to get you into the *View* word-processing system) a particular ROM can be switched in or out of circuit. This technique is known as paging, and the ROM/RAM used to perform it is known as sideways ROM or RAM.

ROM expansion boards are commercial devices that can be plugged into the Beeb to take advantage of the sideways ROM capabilities of the micro. On a standard BBC micro up to four sideways ROMs may be installed at once; with the addition of a ROM board this may be extended to 16.

The term second processor can be taken literally, for that is what it is—an extra micro-processor that is connected to the Beeb. However, a second processor can transform your Beeb into a sophisticated graphics design package (with the 6502 plus Bitstik installed) or a comprehensive business system (Z80 plus software).

ROM expansion boards do not encroach upon the operation of the standard system. Some ROMs can have a disconcerting effect, but only if you have two (or more) ROMs that use the same keywords—then some very annoying things can happen. The solution is to take out the ROM that you do not want to use. Much of the currently available commercial software, sadly, will not run on the 6502 second processor. So the ultimate solution if your software is not working is to switch the second processor off.

See page 94 to check what has appeared in past issues.

and now for the ELECTRON

"By far the easiest word processor to date, yet lacking no features. Even on tape I managed eight full A4 pages of text. Teachers will like it as they can have a disk version at school whilst still having the tape version at home—or shouldn't I say that! Highly recommended.
—Computers in School

"Forget the expensive ROMS and look at the Kansas Word Processor, for no matter what you hook up, the program can be adjusted to accommodate, with liberal instruction in the manual, or else very friendly advice on the 'phone from Kansas."
—Computing Weekly

"The best word processor for the money is the one from Kansas, you just will not believe what it will do, and it really is a pleasure to operate. Others could take a lesson here."
—Which Computer



KANSAS WORD PROCESSOR

ECC—Embedded Control Characters—the method the professionals use

FACILITIES

Tape or disk
Holds 4,200 words in file
Selective search
Global search
Replace words selectively
Format to video or printer
Continuous printing
Separate sheet printing
Draft copy option
Select single or double spacing
Adjustable page length
Optional page numbering
Adjust left margin (4 options)
Adjust line length (4 options)
Centre text
Right justify
Print enlarged text
Print condensed text
Print emphasised text
Print normal text
Underscore on/off
Gives text area used
Gives text area available
Estimates memory location
Display pages
Insert text/ECCs to file
Delete text/ECCs from file
Move up to 255 characters
Duplicate up to 255 characters
Edit whilst adding text
Edit complete text file
Safeguard to Basic
Save file to tape/disk
Load file from tape/disk

ECC means that you are able to type away regardlessly of line ends, margins, new lines or new paragraphs, as ECC does it all—automatically.

All it requires is the pressing of the TAB key and a single letter, and hey presto! you have a new paragraph, with of course a line space and indentation, exactly where you want. Other ECCs will adjust line lengths, varying indentions or even change the printing characters.

Though originally designed for the professional, it is by far the best method for the two finger typist, as there is no need for the amateur to take his or her eyes off the 'copy' to see when the end of a line is reached. The Kansas Word Processor sorts out all the split words during the Format stage, at the same time as adjusting the length of line to suit either the video or the printer.

Though most so-called Word Processors for the BBC are nothing more than letter writers, with the user having to set out paragraphs, indentions, etc., the Kansas Word Processor is exactly as the title states, a word processor. It is thus suitable for any purpose requiring printed words, reports, articles, lists, minutes and of course letters.

The ability to produce as many original copies as required makes it ideal for when more copies are needed as can be done with a typewriter and carbons yet where copying facilities are not readily available. And of course, not only can "hard" copy be produced on paper, but copies can be saved to either disk or tape, for future reference, use or editing.

As a single file will hold well over 4,000 words, articles, stories and the like can be easily accomplished, saving each file separately, for subsequent editing then printing as a whole.

In fact the possibilities for the uses of the Kansas Word Processor are endless, owing to its sheer versatility. It really is a must for anyone with a printer...

For sheer ease of use all the following controls are single keystroke toggling on the function keys:

Add, Edit, Search, Replace, Save Text, Load Text, Inform, Exit Processor, Enter Processor, Clear Text Area, First Page, Next Page, Previous Page, Last Page, Insert Text, Delete Text, Insert Buffer, Clear Buffer. Format. Print.

ADD Allows the inputting of text and the embedded control characters, continuously, with no need to adjust words to fit line ends.

EDIT The full scope of the BBCs editing facilities apply both during the adding of text and when completed.

SEARCH Search for any group of characters. Will show the position of each occurrence.

REPLACE Used in conjunction with the Search facility, you can replace existing characters with new characters. This can either be global or selective. If global is selected, every occurrence of the characters will be replaced. If you select selective, the program will display every occurrence and you will have the option to replace or not.

FORMAT This allows the formatting of the assembled text file, giving various options as to page length, numbering, spacing, video or printer, etc.

PRINT Gives the options of draft or emphasised; continuous or single sheets; double or single spacing; page number and first number; lines per page; number of copies required.

SAVE TEXT Allows the saving of the current text file to tape, with an option to save to disk.

LOAD TEXT This loads a text file from tape (with the option of disk). Numerous text files can be loaded as the one loaded does not destroy the text file already in the program.

INFORM This gives the information of the file in memory and the space still available.

EXIT PROCESSOR This will return the computer to Basic, which is useful for *CAT text files, etc. and to position tapes for loading or saving text files. You will not destroy either the resident text file or the program.

ENTER PROCESSOR Used to enter the program after using the previous command.

CLEAR TEXT AREA Resets all text pointers, clearing text.

FIRST PAGE NEXT PAGE PREVIOUS PAGE LAST PAGE The commands display the text page as asked.

INSERT TEXT Use of cursor keys to insert text or ECCs into existing text file.

DELETE TEXT Use of cursor keys to delete text.

INSERT BUFFER A buffer holding up to 255 characters can be used to either move or duplicate text anywhere in the file, even from page to page.

Complete package includes extensive instruction manual and fuction keys strip

Supplied on cassette with disk conversion instructions

£22.50 All inclusive

Kansas
Kansas City Systems, Unit 3, Sutton Spings Wood, Chesterfield, S44 5XF. Tel: 0246 850357

Recognised Brand Leader in microcomputer software





'Set 'em up' Joe Telford keeps the children busy during the school holidays with half a dozen problems to solve by programming

PROBLEMS? NO PROBLEM!

THIS edition of 'Jottings', again under the Education banner, is unashamedly aimed at the younger User. Mums and Dads should therefore hand over the magazine to their offspring, or even better, settle down with said offspring to do some simple programming based around problem-solving.

But before we solve some problems, we should know what a problem is. Most of us adults picked up a rough idea at school of how to do problems. Because of this we often think all problems are mathematical. Actually a problem is better thought of as something that prevents us doing as we want. This means that we all have problems at different levels:

- John doesn't want to go to school. This poses a problem for John, and possibly for other people.
- Jean cannot decide whether to buy an LP or a blouse. This poses a problem for Jean.
- The school secretary needs to keep track of every pupil in the school each minute of the day. Another problem.
- A bank clerk must change English money into foreign currency at the correct rate. Another problem.

Problems tend to be personal or impersonal. John's problem is personal, as is Jean's, while most school secretaries and bank clerks have the problems outlined above. We can say that these problems are impersonal. Personal problems are usually best dealt with by people, because these problems often need sympathy, understanding, intuition or other human attributes. Computers would make a pretty poor show of handling such problems.

How does Joe solve the problems in this feature?
For six of the best turn to yellow pages xi to xiii.

If we consider problems that are impersonal, we might expect to find such problems as:

1. How can a supermarket improve the service it gives?
2. How can I use a computer to clock-on people in a firm?
3. Which is the best camera?
4. Which is the fastest 1000 cc four-stroke motorcycle?

Here again the problems can be separated into two types. Problems 1 and 3 are general, while problems 2 and 4 are more specific. It is usually easier to obtain a computer-based answer to specific problems than to general problems.

Often, though, problems may have several answers. The correct answer is the one that works in real life. Sometimes many of the answers will work, and sometimes only one. If we consider the type of problems producing one correct answer, these are almost always mathematical. For example:

If six men dig a trench in 12 days how long would it take 12 men?



However, most problems have many different answers, depending on the factors involved. Generally speaking, a problem is made more specific as all the factors affecting it are made clear. For example, in that last problem the mathematical answer might logically be thought to be 6 days, using the principle of doubling the workforce to half

the time. However in real life such a problem is never as simple. The factors which might affect the answer to the problem include:

- What is the maximum workforce available?
- How many men can work on the trench together?
- Must anything be done during the dig? Eg, disconnecting gas/electricity?
- If someone falls ill can he be replaced?

In this article we are mainly interested in finding a solution to each problem. Sometimes the 'correct' answer is obvious, other times there is no 'correct' answer. Provided we try to solve the problem logically this does not matter. Adults should understand that the thinking around a problem is as important as the answer itself.

The first and most important stage of solving problems is to know what the problem is—and we should always write it down. Let's take a typical problem:

How can we easily calculate the amount of foreign money we can buy with a quantity of English money?

The problem is reasonably well specified, but we might not know where to begin. If it's difficult to begin a problem then we should *alter* the problem to be very simple indeed. This helps us to put our thoughts into order. A simpler version of the problem might be:

How much French money can I buy with 15 pounds Sterling?

An easier version still might be:

How many francs can I get for 1 pound?

Now we must think about what extra information we need to solve this simple problem. Obviously we need to know how many francs can be bought for a pound. This is called the exchange rate

OPENUP YOUR COMPUTERS POTENTIAL

WITH **BEL BASE** AND **MAILSHOT** FROM **BEL TECH**

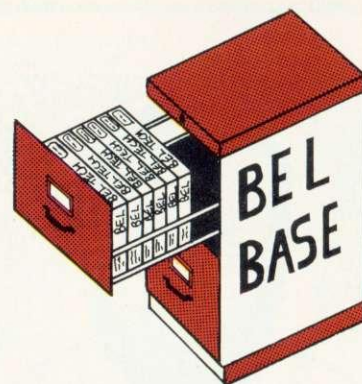

FLEXIBLE, POWERFUL, COMPREHENSIVE YET MENU DRIVEN AND EASY TO USE and INCREDIBLE VALUE FOR MONEY !!!

- * Up to 20 FIELDS and 150 CHARACTERS PER RECORD
- * 600 RECORDS or 90K Characters per File with truly RANDOM ACCESS Disc Version (15K Characters per File on Tape)
- * DEFAULT Values can be set
- * SELECT Disc Drives (0 to 3)
- * CALCULATION Options. Calculate a Field from the value of others, enter Functions etc. – and change them!
- * AMEND the Name, Type, Default Value of any Field
- * SEARCH and REPLACE on all Fields, all Records
- * SELECTIVE and GLOBAL EDITING of Records
- * INSERT Records, DELETE a Field or Record
- * BROWSE Option
- * FIND (Search on any Field) Print Screen if required
- * DISPLAY or PRINT Reports (max. 38/137 characters across)
- * PRINT all Records (2 Fields) or all Data
- * FORMAT OWN REPORTS (Heading, up to 20 Fields, select, sort etc.)
- * SORT on any Field (Ascending/Descending) whether Printed or not
- * SET CONDITIONS (<, >, <=, >=, <=) on any Field, printed or not
- * SAVE Report Formats to a File
- * SUM Numeric Fields
- * SEND Printer Control Characters
- * COMPREHENSIVE INSTRUCTIONS SUPPLIED



MAILSHOT IS INCLUDED IN PRICE OF BEL BASE AS A BARGAIN PACKAGE! !

PERSONAL USE, BUSINESS, ACCOUNTS, EDUCATION, CLUBS, SOCIETIES, FUNCTION, GENERATION – JUST KEEP THINKING OF NEW APPLICATIONS!



AND 'MAILSHOT' SEPARATELY:—

- * USE AS MINI DATA BASE
- * Field, Record Size, Amend, Edit, Search, Insert, Replace, Drive Selection, Browse, Find, Sort, Conditions, Printer Control as BEL BASE above.
- + * LABEL Printing (Std., non std, 1, 2, 3, across)
- + * PRINT any 6 Fields Across
- + * PRINT any 6 Fields Down

FILES ARE COMPATIBLE WITH BEL GRAPH

Order Form	TAPE		DISC		TOTAL
	PRICE	QTY	PRICE	QTY	
BEL BASE	16.00		18.00		
BEL GRAPH	15.00		17.00		
BEL CHEM Chemistry 1	9.50		11.50		
Chemistry 2	9.50		11.50		
BEL GEN Geneology	12.50		14.50		
MAIL SHOT	9.50		11.50		

TOTAL inc. P. & P. £

NAME _____
 ADDRESS _____

 COMPUTER TYPE _____ MODEL _____
 DISC (if applic.) _____
 CREDIT CARD No. PAYMENT BY CHEQUE, P.O. VISA, ACCESS

Please Complete & Return to:-
 BEL TECH Limited, Stanmore Industrial Estate, Bridgnorth, Shropshire. WV15 5HP. or
 Telephone: 07462 5420 (24 Hrs.)

and if we go into our local bank we'll find a list of present-day exchange rates. Francs might be listed as 11.50 francs per pound. The simplest problem can now be solved:

I can get 11.50 francs for 1 pound

The next level of the problem is more difficult. To find out how many francs in 15 pounds, we must multiply 11.50 by 15. We have found a large part of the final solution now because for any currency we can say:

Foreign currency = number of pounds * exchange rate

or

foreign = pds * rate

To handle all the different types of currency we will need a list of all the exchange rates for each country involved. A good way along the path to an answer might be to jot down the sort of sums we might have to get involved in. At this stage we use a cross between English and Basic to put our thoughts onto paper. Eventually we will use full Basic:

```
IF country is France THEN foreign =
pds * 11.50 francs
IF country is Austria THEN foreign =
pds * 36 schillings
IF country is Belgium THEN
foreign = pds * 78.5 francs
IF country is Canada THEN foreign =
pds * 2.25 dollars
IF country is Denmark THEN
foreign = pds * 14.5 kroner
etc
```

The list of exchange rates above is deliberately incorrect, so Users will need to visit their local bank or travel



agent to get an up-to-date list. (Take a notebook and pencil to copy the list from the currency board.) Equipped with this information, we can consider the stages of writing the program.

We have to do three things to solve this problem. Our first ideas might be:

1. Enter the English cash.
The exchange rate.
The country involved.
The name of that country's currency.
2. Perform the correct calculation, depending on the country involved (as shown above).
3. Print out the answer.

In banking the exchange rate, the currency name, and the country name would be always available to staff, and the real input would be the name of the country and the quantity of English cash. We need the country name so that the correct exchange rate can be found, and the quantity of cash to perform the multiplication necessary.

A useful approach when coding these problems is to make each major part of the solution a procedure in its own right. Then if a bug occurs in one part of the program it can be tracked down by considering each section in turn. These stages can then be swiftly hung together using a main program body like:

```
50 REPEAT
60 PROCinput
70 PROCprocess
80 PROCdisplay
90 PROCspace
100 UNTIL FALSE
```

The three main procedures can be used over and over (until ESCAPE is pressed) and the PROCspace procedure allows each answer to be read before progressing to the next input. A large number of simple problems can be handled in this format. Program 1 shows one solution to the Bureau de change problem. The processing section requires the addition of further countries, currencies and exchange rates, but this is a useful way to spend an afternoon collecting data. Users should also consider writing their own versions, or improving on program 1. Alternate modes, coloured printout and making tabularised output might all be considered.

The second problem to solve derives from the well-known riddle: 'When is a Beeb not a Beeb? ... When it's a POST'. A POST - Point Of Sale Terminal - can be regarded as a special cash register. In its simplest form it can do five tasks:

1. Input amounts of money.
2. Total them.
3. Input the amount paid.
4. Calculate change needed.
5. Display the change to be given.

The problem is to simulate a POST with the BBC micro. The above POST spec. gives us our outline for solving the problem. Let's examine the task in detail. We can start by thinking of the main body of the computer program. We can produce this directly from the problem spec. The solution starts by taking the general problem and breaking it down:

```
50 REPEAT
60 PROCinputandadd
70 PROCtotal
80 PROCinputcash
90 PROCcalculatechange
```

```
100 PROCshowchange
110 PROCspace
120 UNTIL FALSE
```

Notice that each of the procedures roughly matches the stages of the problem specification. The REPEAT ... UNTIL loop and PROCspace are simply trimmings that will make use of the program easier.

The next step is to produce 'English-Basic' pseudocode solutions to each of the procedures. The 'inputandadd' procedure might be summarised as follows:

```
Make the total 0
REPEAT
  INPUT the cost of an item
  IF the cost is more than 0 add it onto the total
  UNTIL the cost is 0
END this section
```

Compare this with the coding of program 2 to see how each line relates to our summary in pseudocode.

The procedure to print the total of the items is easy to produce, as it will simply be a PRINT statement (lines 240 and 280).

In the section of the problem dealing with entering the cash paid a small problem might arise if someone offers an amount less than the actual total. This must be spotted. It is as covered in the following pseudocode:

```
REPEAT
  Input the cash paid
  UNTIL it covers the cost of items
```

This code transfers very easily into Basic:

```
REPEAT
  INPUT 'cash paid 'cash
  UNTIL cash >= total
```

Readers will see the benefit of using long variable names. The last two sub-problems, calculating the change and printing the amount returned, are covered simply by a subtraction:

change = cash - total

and then one or two PRINT commands. Program 2 shows the detail of these procedures.

To produce a pleasant layout, '-' characters are used in the printout sections of the program, and an additional aid to layout is the use of the @% variable in line 160 to produce two figures of decimals. The Z% variable is used to return the @% variable to its original state. This is important because in leaving one program to start another we should always reset the system variables that we have altered. This is actually done in line 440.

This problem should lead to many other ideas, possibly the most import-

Now you need not pay through the nose for a good face!

TAXAN

TAXAN

By choosing a TAXAN KP810 or KP910 NLQ dot matrix printer from Kaga, you can count on getting the very highest quality, reliability and value.

PRINT QUALITY

Both printers offer all the standard features found in dot matrix graphics printers. But really excel when it comes to Near Letter Quality (NLQ) printing, producing output that equals or exceeds the quality of printers costing considerably more.

FEATURES

The KP810 and KP910 share some very impressive features: ■ 160 cps print performance. ■ NLQ double pass printing – selectable at switch on. ■ Unique incremental printing mode. ■ Friction feed and tractor feed. ■ Standard Centronics interface (serial option available). ■ Fully compatible with all popular

software packages, including *Lotus 1-2-3*, *Applewriter*, *Wordwise* etc.

The KP810 has a built in roll paper holder. The KP910 will accept extra wide paper (up to 17") – printing 156 char/line normal print.

VALUE

With all these features you might expect to pay more. But at around £299 for the KP810 and £399 for the KP910, these printers give excellent value for money.

All prices ex-VAT and correct at time of going to press.

TRADE AND OEM ENQUIRIES WELCOME.

AVAILABLE FROM W. H. SMITH AND OTHER PROFESSIONAL DEALERS NATIONWIDE.

EXCLUSIVE UK DISTRIBUTOR. TAXAN IS THE NEW BRAND NAME FOR PRODUCTS MANUFACTURED BY KAGA ELECTRONICS CO. LTD.



Whatever your system... insist on KAGA TAXAN

Data Efficiency Ltd

Computer Peripherals Division, Maxted Road, Hemel Hempstead, Herts. HP2 7LE Tel: (0442) 60155 (20 lines) Telex: 825554 DATEFF G

KIF-4308 MULTIPURPOSE TYPE PRINTER BUFFER

NEW



64K RAM buffer, expandable to 256K, capable of controlling two separate printers at one time... and more.

RING 0442 60155 FOR DETAILS

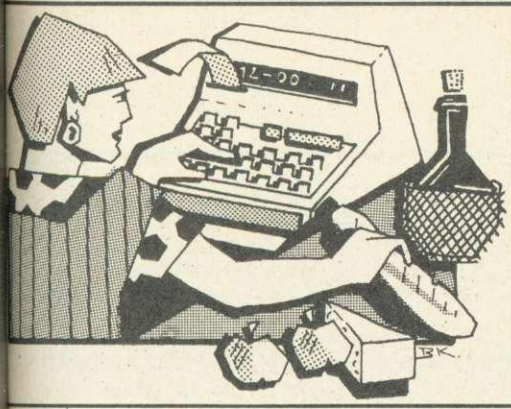

ant being to visit a number of shops where POSTs exist and see what they do. This provides a jumping-off point for a number of investigations, eg:

- Can you make your BBCPOST open a cash drawer (or simulate this)?
- Can you perform a coin analysis of the change so that the BBCPOST prints out how many 1s, 2s, 5s, 10s, 20s, 50s, and 100s should be given in change?
- Can you introduce a code into the input section so that BBCPOST will tell you what the article is when that code is typed in?
- Can you further extend this idea so that BBCPOST tells you not only the code but the price too, and then adds that price onto the total?

The next problem is all a matter of timing. We regularly use the 12-hour clock, so that say 6 hours after 11am is 5pm. In this type of arithmetic:

$$11 + 6 = 5$$

If we want to demonstrate this using our BBC micro, then we need to perform three stages of problem-solving. You should be able to name the procedures in the main body of the program now:

```
REPEAT
PROCi....
PROCp.....
PROCo.....
PROCspace
UNTIL FALSE
```

The difficulty in this program is not in entering the numbers. All that is required here are a number of INPUT statements to get the hours and minutes of the present time, followed by the hours and minutes that will pass before the new time. Nor is the difficulty centred around the printout of the final time—a simple PRINT line will take care of this. The difficulty lies in the calculation of the new time. Let's therefore consider this aspect in more detail.

If we add the present minute value to the number of minutes that have passed, then we will get a value that is either under one hour or under two hours (unless something silly like 120mins has been entered). So we have to take into account a possible 'hours carry'. When we add this hours carry to the present time in hours and then to the number of hours to pass, the

answer will be greater than or less than 12. If the answer is less than 12 we simply use it as it stands. If the answer is more we must reduce it by subtracting 12 until the answer is less than 12. A special case occurs when the answer is exactly 12. This normally reduces to 0 but convention has it that the 12-hour clock starts at 12, and so any answer of 0 hours must be called 12 hours.

As we've said, when a problem looks difficult its best to break it down into manageable chunks. The last section should show us that the smaller chunks include:

1. Adding the minutes.
2. Checking for a minutes-hour carry.
3. Adding the hours plus carry if any.
4. Checking for the hours result over 12.
5. Reducing this by 12 until the result is in the range 0 to 11.
6. If the special result 0 occurs then add 12.

The clearer outline of the last section allows us to produce our English/Basic pseudocode solution:

```
new min time = present min time +
passing min time
hours carry = new min time DIV 60
new min time = new min time
MODULO 60
new hour = present hour + passing
hours + hours carry
new hour = new hour MODULO 12
IF new hour = 0 THEN set new hour
to 12
END this section
```

This process of moving from outline problem via progressively clearer stages to a solution is called refinement. Program 3 shows a completed solution in PROCprocess (lines 280 to 350). This is the Basic coding of our pseudocode. It is, however, possible to go a step further and produce an alternative process, defined in lines 390 to 430. This relies on understanding the first PROCprocess and reducing it to three essential expressions. The brackets contain all the contents of the original PROCprocess but in a condensed form. This further enhancement does not improve the solution, it simply makes it more concise, if less readable. This sort of condensation is normally applied to increase program execution speed, or reduce demands on memory space. Normally (say for exam purposes) the original PROCprocess would be quite satisfactory.

Here are further things you could do to develop the program:

- Can you add lines to input the time of day as AM or PM and printout the final time with AM changed to PM and vice versa, if need be?
- Can you convert this program to

work as a 24-hour clock?

Can you produce a program that converts between 12 and 24 hours?

Can you produce a program that takes days of the week into consideration, in either the 24-hour clock or the 12-hour clock with AM or PM?

Can you produce a calendar for this month? Any month this year? Any month of any year?

The information picked up so far will prove useful in this next problem. The wages department of a large firm is to use a computer to work out the wages of each employee. The various sub-problems have been listed and you have been presented with the sub-problem of using the computer to calculate the number of hours worked each day by each employee.

On collecting further information from the personnel department you come across the following facts:

1. No-one starts work before 7.30am
2. No-one works later than 6.00pm
3. Times are always given in quarter-hours. This means that a person who clocks off at 5.55pm will be regarded as clocking off at 5.45pm.

Ignoring item 3 for the moment, you should go through the stages of solving the problem. Consider what will be the input, the output, and what processing must take place. Write the main body of the program. Think about the problems involved in calculation. Remember the complete work time will normally be made up of a morning session (clock-on up to 12) added to an afternoon session (12 till clock-off).

Program 4 shows a possible answer to the problem. Notice particularly the way in which it handles input, protecting against out-of-range numbers. However, it does not handle the quarter-hour specification. Let's add the quarter-hour facility. This sub-problem can be specified more completely as:

'When a person clocks in, the clock-in time is taken forward to the next quarter-hour, unless the person clocks in on a quarter-hour. When a person clocks off the clock-off time is taken back to the last quarter hour, unless the person clocks off on a quarter-hour.'



We need to add this section to the overall solution. We can indicate our intent to do this by adding line 45:

```
45 PROCfindquarterhour
```

This will need to be defined after line 500, beginning:

```
510 DEF PROCfindquarterhours
```

and ending with ENDPROC.

To decide on suitable coding, we produce our usual pseudocode based on the problem:

```
Make offmins = offmins DIV 15
Make offmins = offmins * 15
Make onmins = onmins + 14
IF onmins > 60 increase onhour by 1
Make onmins = onmins DIV 15
Make onmins = onmins * 15
```

This can easily be converted to Basic on a line-for-line basis. Readers should try coding this procedure.

Here are some more challenges:

1. Can you change program 4 so that it includes as input and output the name of the person? This can easily be done by adding an INPUT line and a PRINT line.
2. Can you alter the program to take account of a five-day week? This will involve adding the totals of each day together.
3. Can you alter the program to cope with a workforce of 10 people?
4. Can you alter the program to work out the weekly wage of each person if the hourly rate is included in the input section with the person's name?

This next program should start with an experiment. The first task is to get a candle, say two centimeters in diameter. Attach it to a secure base and mark two lines around the candle about 1 or 2cms apart. Light the candle and time how long it takes to burn down from the top to the bottom marks. This time will probably be in minutes. For Users without a stopwatch, simply enter this short program, then press SPACE to start timing, and RETURN to stop:

```
10 REPEAT UNTIL GET = 32
20 TIME = 0: REPEAT UNTIL GET = 13: t = TIME
30 PRINT t DIV 6000 " min: "; (t DIV 100) MOD 60 " sec"
```

Whatever the timing method, we will end up with the time taken to burn a certain quantity of wax. The quantity consumed can be found by the formula:

$$\text{quantity} = \frac{\pi \cdot \text{diam} \cdot \text{diam} \cdot \text{length}}{4}$$

For a first approximation we might use a value of 3 for pi.

The problem this experiment leads us to is:

Is it possible to take the data about one candle and from it predict the burning times of other candles?

Our first attempts will probably be inaccurate. In this type of problem, the accuracy of the computer output depends on the quality of our model. The model here is simply: 'The greater the amount of wax to burn, the longer will be the burning time'. This allows us to calculate burning time based on diameter (thickness) and length of candle. The model may not hold true for widely differing diameters of candles, and there are different hardnesses of wax, which will also affect the outcome. The program produced in answer to this problem will no doubt need refining, but it provides a starting point.

Considering our experiment, we need to produce a program that takes the test data (length, diameter, burn time) and the new candle data, then calculates the burn time for the new data. This falls into our three areas of Input, Process and Output. With the exception of having two input sections – one for test data and another for the prediction data – the main body of the program reflects this. Readers can create suitable input and output routines by examining program 5. The calculations required are quite simple:

1. Calculate quantity burned in test using previous formula.
2. Calculate actual quantity to burn using same formula.
3. Calculate predicted burn time by: $\frac{\text{actual quantity} \cdot \text{testburntime}}{\text{test quantity}}$

The resultant procedure is shown in lines 240 to 300.

To give the program a good tryout, select three candles: a birthday cake candle, a candle identical to the test candle and a really thick candle. Mark a top and bottom ring on each candle, making the distance between the rings 1cm on the thick candle, 4cms on the test candle duplicate, and 2cms on the birthday candle. Run the program three times with the data for the test candle and note down the predicted burn times for the three candles. Time each candle in turn, recording its actual burn time. Comparing the answers with the computer predictions will demonstrate the accuracy of the model.

Further exercises:

1. Can you alter the program so the test results can be permanently stored?
2. Can the program be altered (with permanently stored test results) to cope with three models:
 - a. The thin long candle.
 - b. The standard candle.
 - c. The short thick candle.

3. Can you find out whether the type of wick plays any part in the speed of burning?

4. Can you devise a model that compensates for the type of wax?

Our last problem concerns the inhabitants of a distant world (the P&G? – Ed). On this planet the most advanced form of life is the Tibbar, a small furry creature. There are no predators to prevent the Tibbars increasing in population. This they do quite often, for a Tibbar will grow to maturity in four months, at which point it can start breeding. Tibbars have perfect litters of four Tibblets (two male and two female) which tends to produce a perfectly even balanced population. Program 6 shows how a model of population growth can be started. The interesting line is line 230, which increases the population every four months.

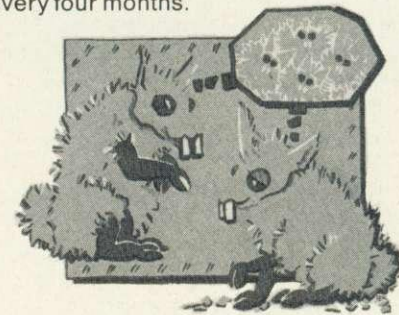

The trouble with computer models or simulations is that they are not perfect. They simulate the parts of real life we are interested in at the expense of other parts. The simulation of program 6, for example, looks only at an increasing population. There is nothing to take account of natural wastage. Another failing is that the program assumes that the population starts at two. This might not be the case – for example, if a herd of zebra is being monitored, a model might need to start with 12 or more creatures. There may need to be an imbalance of males to females, and the maturity period may need to be increased.

The main problem with such a model is that to provide a realistic simulation we must be aware of all the sub-problems that might arise, and how to solve them. Hence we have turned full circle.

We started solving simple problems directly, and have ended up thinking about producing programs which demonstrate their own weakness as solutions.

If we agree that the main aim of programming should be to help problem-solving, then every program, working or not, assists us on that road. Provided we constantly refine our ideas and learn from our mistakes, we will develop the strategies and skills to solve the many different problems that life brings.



Print from Japan

Disk Drives from Cumana

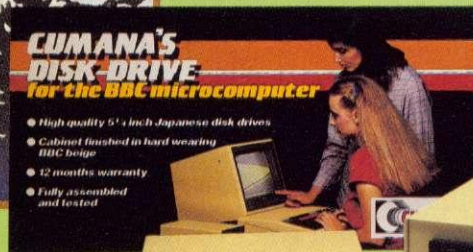

Like the beautiful prints from Japan, Cumana disk drives represent the very highest standards in design and production. Also like the prints, Cumana disk drives represent the highest state of the art; and they not only look beautiful, they perform beautifully as well.

Cumana disk drives for the BBC Microcomputer are available in slimline single, dual and dual switchable versions. They have 12 months warranty, are fully assembled and tested before packaging, and are available — at unbeatable value for money prices — from W. H. Smith, The John Lewis Partnership, Greens Leisure, Laskys, Spectrum UK, area distributors (see below) and Cumana's national dealer network.

Look out for the distinctive Cumana packaging in your high street, today!



Area distributors:
 HCCS Associates (Gateshead) 0632-821924, Eltec (Bradford) 0274-722512, Basic Business Systems (Nottingham) 0602-819713, Walters Computer Systems (Stourbridge) 03843-70811, Microage Distribution (North London) 01-205 7688, J. S. Simnett Computers (South London) 01-541 1495, Gwent Computers (South Wales) 0633-841760, National Micro Centre (Stockport) 061-429 8080, Microworld (Edinburgh) 031-228 1111, Microtest (Cornwall) 0208-3171, DRG Business Machines (Weston-Super-Mare) 0934-415398, Kingdom Design (Belfast) 0232-643720, Hugh Symons (Bournemouth) 0202-26535, Audio & Computer Centre (Jersey) 0534-74000, Peco Electronic (London) 01-543 1030 (Brighton) 0273 688395/6, Clwyd Technics (North Wales) 035 283 766, + National Dealer Network.

The Highest State of the Art



Cumana Limited,
 Pines Trading Estate, Broad Street,
 Guildford, Surrey, GU3 3BH.
 Telephone: Guildford (0483) 503121.
 Telex: 859380.

For further information about Cumana disk drives for the BBC Micro, please complete and return this coupon.

Name _____

Address _____

Tel. No. _____

Interests:

Home Use

Education

Dealer

Business

AU9/84

Note: If dealer, please attach this form to your letterheading.

Rebalance this sheet

The BBC Micro can now give an astonishing new account of itself.

Because with Acornsoft's new 16K ViewSheet ROM, it develops a head for figures which can save you a vast amount of arduous brainwork.

Imagine, for instance, that you had to make several adjustments to a balance sheet.

If you made those adjustments on ViewSheet, it would revise the balance automatically in a split second.

Or imagine that you had to add 15% VAT to every figure on a price list containing 500 items.

ViewSheet can add the tax to each and every one of those items simultaneously. And once again, in virtually a second.

As simple as pencil and paper.

ViewSheet is a computer-based spreadsheet, the figure processing version of a word processor.

With 255 columns in width and 255 rows in depth, it's also one of the largest spreadsheets on the market.

Originating the sheet is as easy as originating an ordinary worksheet with pencil and paper.

Because ViewSheet comes with an easy-to-follow reference card.

It enables even the most inexperienced users to feed all the data they need to use, and store on disc or cassette, into the BBC Micro.

You can nominate headings and sub-headings. And you can create barcharts to display figures graphically.

Ten windows for perfect vision.

The sheer size of ViewSheet makes it impossible for the whole sheet to be visible on the monitor at once.

That's why ViewSheet has ten windows, enabling you to see up to ten different sections of the sheet at any one time.

You can summon the windows onto

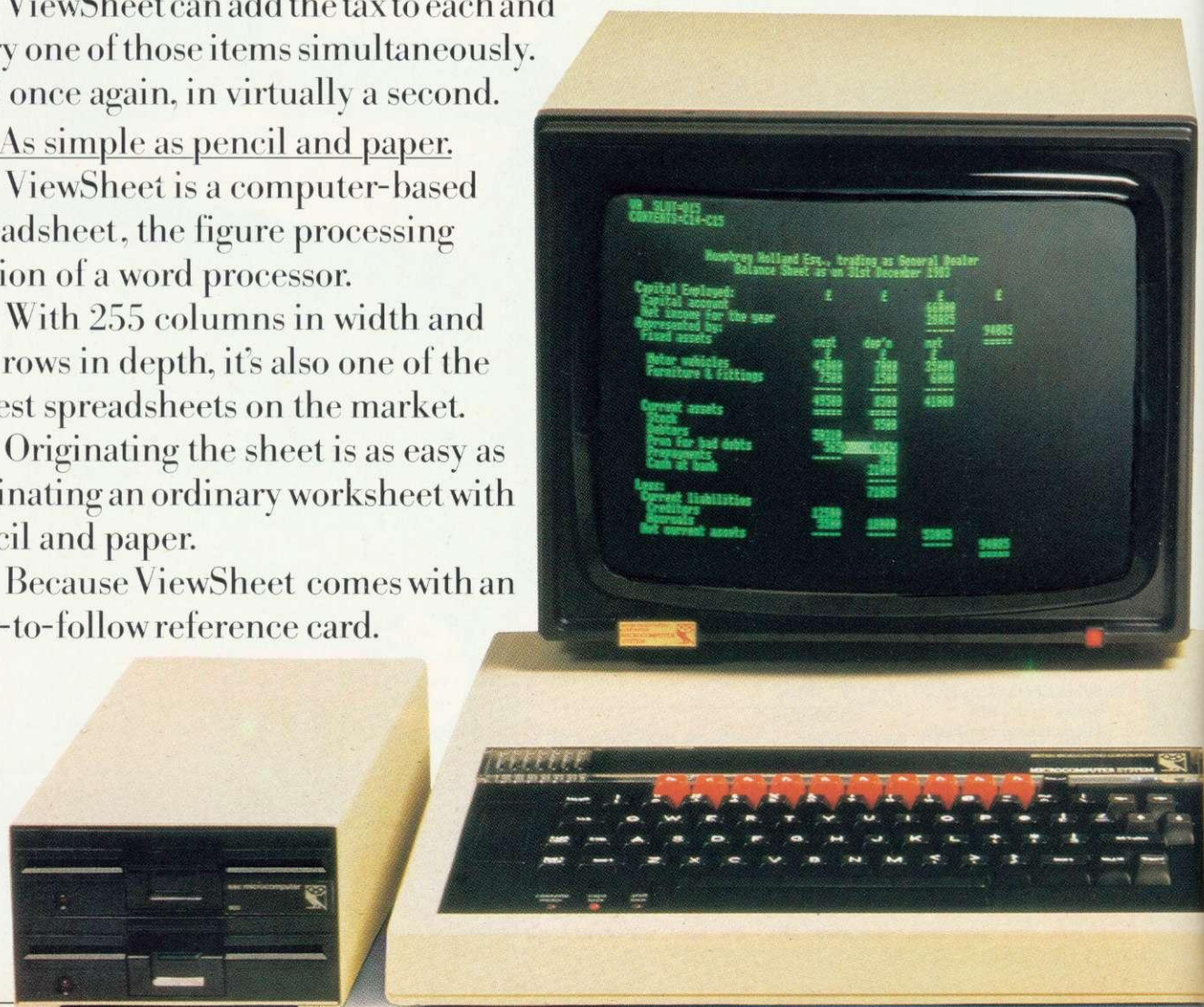

meet in one second.

the screen at the press of a key.

You can cross-reference sections, or even reposition them on the sheet, whenever you need to.

And you can print them out individually, as well as all together.

The possibilities are virtually endless.

By creating special disc files from ViewSheet, you can link two or more spreadsheets together. This means you can build models much bigger than the BBC Micro's considerable memory.

ViewSheet is also compatible with Acornsoft's View word-processing package. This enables you to produce reports and documents which combine text and figures.

In addition, you can use ViewSheet in any screen mode,

making the most of the BBC Micro's potential. And if you use it with the 6502 second processor, you'll have no less than 30K of workspace in any mode.

For only £59.80,

you too can have figures like this.

The ViewSheet ROM can be fitted by your BBC Micro dealer in less than three minutes. And with its straightforward user guide, function

key card and reference card, it'll soon have you juggling figures at lightning speed.

Indeed, at only £59.80, it's an invaluable asset for anyone involved in professional or personal finance, forecasts, formulae and analysis.

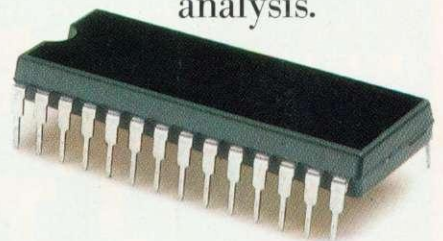

ViewSheet's operations and functions in brief.

The operations supported by ViewSheet are: addition, subtraction, multiplication, division, exponentiation and bracketed operations.

And the functions supported are: ABS, ACS, ASN, SIN, SGN, RAD, ATN, COS, DEG, EXP, INT, LN, LOG, PI, SQR, TAN, MIN, AVERAGE, MAX, CHOOSE, LOOKUP, COL, IF, READ, ROW and WRITE.

ACORN SOFTWARE

c/o Vector Marketing, Denington Estate, Wellingborough, Northants NN8 2PL. Tel: 0933 79300.

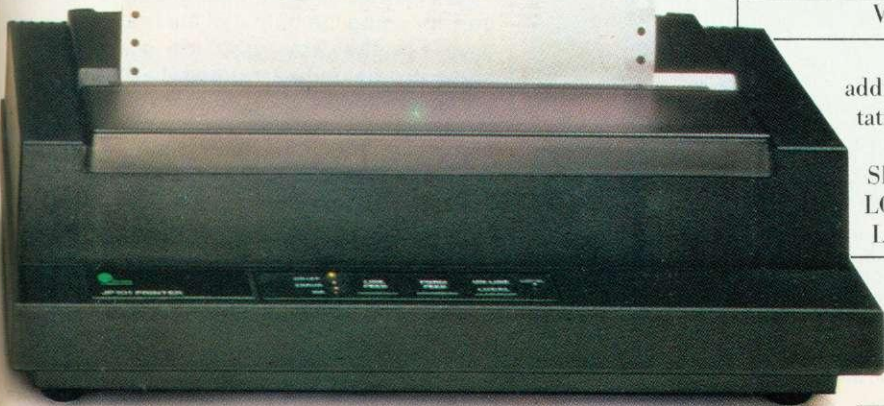

SPRITELY CHARACTERS

74

Create your own full-colour cartoon figures in a flash with Harry Sinclair's sprite generator program

... and next month he'll show you how to animate them

THE GRAPHICS capabilities of the BBC and Electron are second to none. What Acorn calls medium-resolution graphics are called high-resolution by other manufacturers. The graphics commands and character redefinition facilities are excellent and are all that most people require. However, there are limitations. Redefined characters are single colour, animation is not easy, and large user-defined characters have to be made up of a number of standard-size units.

These problems can be overcome by directly addressing screen memory,

although for some obscure reason Acorn regards this activity as being on roughly the same moral level as wife beating. Resolution, number of colours and size are limited only by the mode you choose and movement is considerably faster and smoother.

So why don't we use this method all the time? Well, Acorn has not provided facilities for making it easy and so to take full advantage of the method you really need to use machine code, which puts people off.

Two main facilities need to be provided:

- Routines that allow the user to create characters (sprites) without having to perform the rather messy manipulations required to change the colour of each pixel.
- The means to move these creations to any screen location quickly and without worrying about internal screen boundaries.

This article introduces a program which performs the first of these tasks, and next month I'll present a program that takes the output from this month's program and moves it around the screen smoothly without disturbing any background, maintaining your character's original colouring at all times - EOR printing is not used.

Your characters can be as large as 24 pixels deep by 20 pixels wide or as small as one pixel - in which case I will be exceeding myself, having toiled through many a night, these wonders to bring you.

The programs are designed in such a way that it is not necessary to understand how the whole process operates or to know anything about assembler. If you either know all about these matters or don't want to know, you can get on with typing in the *Design* program after reading the next section.

All you need to know - and this is only for using the output of the first program - is the way graphics co-ordinates are actually arranged. In all the graphics modes (0, 1, 2, 4 and 5) the Beeb regards the screen as being 256 bytes deep (Y axis), with 0 at the top of the screen and 255 at the bottom. The X axis has two possible ranges - 0 to 39

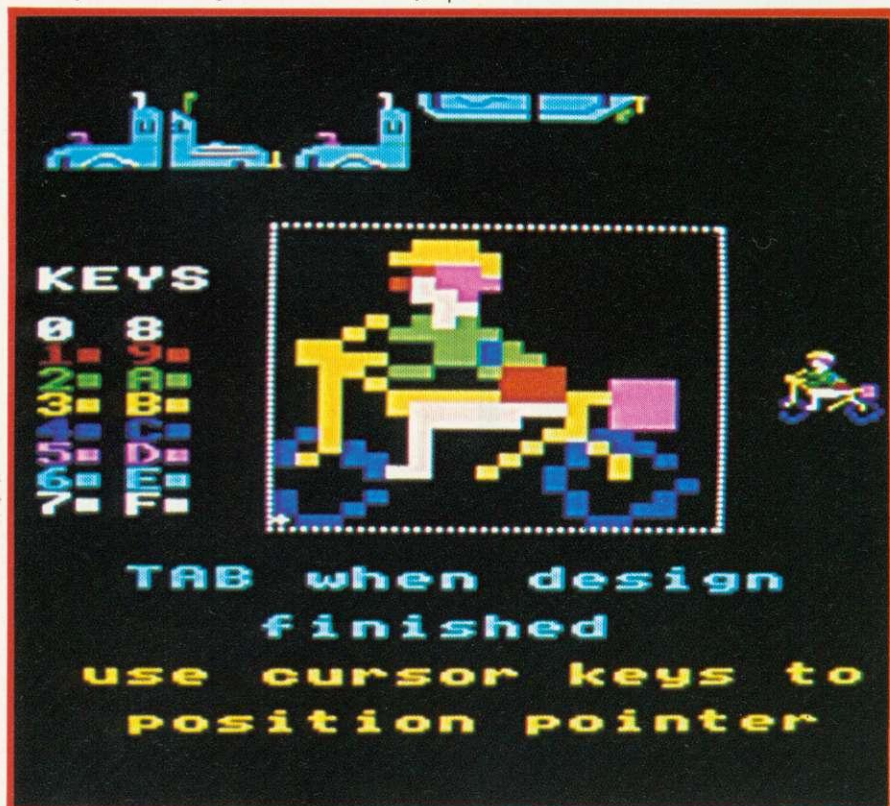

Easy Rider was designed using the largest grid and is shown at its final size on the right. Colours are selected from the palette (left) by moving the cursor to the appropriate position and pressing a number key

The Design program is listed on yellow pages viii-ix, with full entry and conversion instructions on page x



for modes 4 and 5, and 0 to 79 in modes 0, 1 and 2. This explains why mode 2 (256 bytes deep by 80 bytes wide = 20k) requires twice as much screen memory as mode 5 (256 bytes deep by 40 bytes wide = 10k). These programs use mode 2, so to position your sprites on the screen you should use values in the range 0 to 79 for the X axis. The way to call up sprites is:

1. Run the *Design* program and design your characters.
2. Allow the program to save them.
3. Type ?&70=(the number of the character you want to show).
4. Type ?&71=(X axis number).
5. Type ?&72=(Y axis number).
6. Type MODE 2:CALL display.

Note that 'display' is an assembler routine within *Design*. This will provide only a static display—no animation (except by clever use of flashing colours). Next month's program will allow two sorts of animation—movement of individual sprites and multi-frame animation using a sequence of sprites as in a cartoon film. OK, if you don't want to read the next section on how the program works, start typing *Design* in now.

How the program works

Mode 2 allows the use of all 16 colours (0 to 15) and so there are two pixels per byte. This is because the number of

each colour has to be written to the screen memory byte in a particular format. Each byte is made up of eight bits. Four bits are necessary to represent numbers in the range 0-15 so you can fit only two such numbers in each byte.

Say you want a particular screen byte to be magenta (colour 5) on the left half and flashing blue/yellow (colour 12, or &C in hexadecimal) on the right. Sending the value &5C to the byte does not work. What you have to do is interweave the colour numbers in a special way.

Magenta	Blue/yel	
0	1	1st pair = 01
1	1	2nd pair = 11
0	0	3rd pair = 00
1	0	4th pair = 10

Table 1. How to interweave the colour numbers in binary

The first step is to convert each number into its binary equivalent. Five is 0101 and 12 is 1100. The method is then to take the left-hand (most significant) bit of the first number, the first bit of the second number, the second bit of the first number, the second bit of the second number and so on. It sounds complicated but if you just write the numbers in binary vertically next to each other and read off the pairs it's

very easy. Table 1 shows how this works in our case, where the final number is 01110010. Rather than convert that number into a decimal number it's much easier to convert it directly into hex. Just consider each half of the byte as separate so that you have two numbers—0111 and 0010. Each will now convert into a single hex digit in the range 0-F. In this case you will get 7 and 2. The final hex number is therefore &72. If you're not very happy about converting from one number base to another table 2 gives all the required values.

page 77 ▶

dec.	bin.	hex.
1	0001	1
2	0010	2
3	0011	3
4	0100	4
5	0101	5
6	0110	6
7	0111	7
8	1000	8
9	1001	9
10	1010	A
11	1011	B
12	1100	C
13	1101	D
14	1110	E
15	1111	F

Table 2. Conversion table for decimal, binary and hexadecimal

DESIGN PROGRAM DESCRIPTION

10 to 200 Perform initial housekeeping—clearing work areas, assigning constants, defining the characters used in the program as the representation of a pixel (CHR\$240) and the pointer/cursor (CHR\$241), assembling the machine code, and setting up 'key\$', which is used to find out which colour control key has been pressed.

210 Starts the outer loop, which is used each time a new sprite design is started.

220 Works out where to store the data for each design by looking at the appropriate entry in the table of addresses starting at &12F0.

230 to 240 Draw previous designs across the top of the screen, having calculated the gap required between each design to give even spacing. This is necessary since designs can be anything between 8 and 20 pixels wide.

250 to 270 Print out the details of the colour control keys.

310 to 350 Position the 'design box' centrally, draw it, and draw the pointer/cursor in the bottom left of the box.

360 Start of the inner loop, which controls cursor movement, colour change and the creation of the data table for each design.

370 Checks whether a key has been pressed and, if so, whether it appears in the string variable 'key\$'. If one of the appropriate keys has been pressed, K% will contain the number of its position within the string—eg if 0 has been pressed K% will equal 1—the position of 0 within

'key\$'. If F has been pressed K% will equal 16. If a non-acceptable key has been pressed K% will equal 0. Caps lock *must* be on.

380 Sets col%, the colour required, to equal K% - 1 and draws the representation of a pixel in the correct place and in the correct colour.

390 to 420 Check if any of the cursor control keys have been pressed and, if so, delete the cursor/pointer at its present position, adjust the X and Y co-ordinates and draw it in the new position.

430 The end point of the inner loop, which is exited when the TAB key is pressed.

440 Updates the number of the character ready for the next design and ensures that character 2 is the same as character 0 and character 6 the same as character 4.

450 Reactivates the text cursor, clears the text window and switches off the flashing cursor.

460 to 480 Exit conditions for the outer loop. These are:

1. Memory full
2. CTRL-Z pressed

Pressing SPACE allows a new design to be started unless condition 1 is true.

490 to 510 Re-enable the edit keys and switch to mode 7.

520 to 530 Provide information on the whereabouts of the data tables for the characters you have designed.

540 to 550 Allow you to save your data.

560 to 570 End of main program.

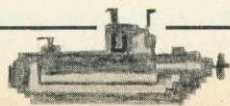

Increase your fire power!



More than just a joystick - a system

- ▲ Nylon encased — Steel shafted joystick with ball and socket joint.
- ▲ Fast sprung return to centre.
- ▲ Graphite wiper linear potentiometers.
- ▲ 12 Months Guarantee.
- ▲ 7 day Money back Guarantee (on Hardware).

DELTA 14b HANDSET £14.95
DELTA 14b/1 A/D/USER PORT INTERFACE £14.85
DELTA DRIVER CASSETTE £5.95 or DISC £9.95
 Prices include VAT and P&P. SAE for more detailed information.

VOLTMACE LTD
PARK DRIVE
BALDOCK
HERTS
SG7 6EZ
 Tel: (0462) 894410

Numerous stockists nationwide or direct from us.



Callers welcome at the factory — Monday to Friday.

Complete control at your fingertips

A superb joystick and a keypad for the price of either one. Plus the software to integrate it into the computer's system.

One handset will work on it's own in the A/D port as a joystick and two fire buttons. Joystick is immediately compatible with ACORNSOFT and similar software. The interface joins together the analogue and the user ports to use the full keypads giving a total of 24 user definable keys. The interface can also be used as a splitter for the A/D port to take two items at the same time, e.g. joystick and lightpen.

DELTA DRIVER on cassette or disc: Two programs on each cassette or disc. One converts machine code programs from the keyboard to the joystick or keypad, with adjustable sensitivity on the joystick and will run on any O.S. The second program (needs O.S. 1.0 or later and an interface) duplicates any keyboard keys on the keypads, in the operating system, so that it can become a numeric keypad or will take on the function keys.

Voltmacedelta 14b



**NOW AVAILABLE
FOR THE
electron**

**THE SIR COMPUTERS
PRINTSTICK**

SEE US AT

The 2nd
Official
Acorn User
Exhibition

OLYMPIA
16-19 AUGUST
1984

**ONLY
£44.95**

JOYSTICK FACILITIES:

- * Provides connections for two standard Atari-type joysticks, allowing the use of two-player games.
- * Immediately compatible with all games offering a joystick option.
- * Extra commands allow joysticks to be defined as any combination of keys, allowing all keyboard-operated games to be used with joysticks.
- * Joysticks may be read directly from BASIC using the ADVAL(n) function.

PRINTER FACILITIES:

- * Provides connections for a standard Centronics-type printer.
- * Allows use of all BBC Microcomputer printer control commands.
- * Special command enables a graphics screen to be copied to any Epson dot-matrix printer.

ADDITIONAL SPECIFICATIONS:

- * Only Acorn-approved memory locations are used, ensuring complete compatibility with any future devices (sideways ROM/RAM, sound expansion, speech synthesiser, disc system etc).
- * All operating software is held within a paged ROM and is available for use from the moment the computer is switched on. THERE IS NO NEED TO LOAD ANY ADDITIONAL SOFTWARE FROM CASSETTE.
- * Housed in a sturdy plastic case.
- * Full twelve month guarantee.
- * Available direct from SIR COMPUTERS for only £44.95 (inc VAT). Please include £1 postage and packaging.

SIR COMPUTERS — First for Electron support

All our prices are inclusive of VAT. Please include £1 P&P (UK only) for every item ordered on this page. We also stock a complete range of printers, monitors, disc drives and software — with many hard-to-beat prices. Please telephone us for details.

Access/Barclaycard. Telephone orders welcome.

SIR COMPUTERS LTD
 91 WHITCHURCH ROAD, CARDIFF CF4 3JP.
 Telephone: CARDIFF (0222) 621813.

Also available for the ELECTRON the SIR ADC/PRINTER INTERFACE

NOT JUST ANOTHER JOYSTICK PORT — FULL ANALOGUE-TO-DIGITAL CONVERTER provides fully proportional control, essential for use with graphics packages, digitizers, etc; ideal for scientific and educational applications; usable with a wide variety of BBC Micro-compatible analogue and switched Joysticks/Paddles.

CENTRONICS PRINTER INTERFACE — allows use of a wide variety of parallel printers including entire Epson range; complete firmware support included.

HIGH-QUALITY MOULDED CASE — attractively styled plastic unit bolts securely to the back of the computer.

EASY-TO-FIT — no soldering, simply plugs straight into computer's rear edge-connector and is held in place by twin bolts; edge-connector on back of unit provides for further modular expansion if necessary.

THE SIR ELECTRON PRINTER/ADC INTERFACE £65.95

THE SIR ELECTRON ROM/RAM EXPANSION BOARD

Provides 12 extra sockets which support a variety of ROM and RAM configurations up to a maximum of 192K for ROM and 16K for RAM.

ROM and RAM is normally paged in 16K blocks but is easily switchable to 2K, 4K or 8K blocks.

Easy to install — just plugs in.

Professional styled casing bolts to rear of computer.

Fully buffered design.

Permits use of most BBC ROM-based software including utility ROMs, wordprocessors and languages

Price: £59.95

NOW COMBINED: BOTH THE ABOVE UNITS (ROM/RAM Expansion Board and Printer/ADC Interface) IN ONE CASE! A complete and comprehensive Electron expansion — ideal for word-processing applications among many other uses.
ONLY £99.00!!

The task of interweaving numbers in this way would be quite tricky, if not impossible, from Basic but is fairly simple in assembler, where individual bits can be manipulated.

Well, that's all there is to the control of pixel colours. Layout of screen memory is the next item. I don't propose to go into any great detail in this article but it is useful to have a general understanding of the subject. Type in the following short program.

```
10 *TV255
20 MODE 2
30 FOR I% = 0 TO 8
40 I%? &4900 = &72
50 G = GET
60 NEXT
```

All this program does is to send the

value &72 to 9 (0 to 8) consecutive screen memory locations starting at &4900. When you run the program the first byte will light up with the left-hand pixel in colour 5 (magenta) and the right-hand pixel flashing blue/yellow. Each time you press a key the next byte will light up.

You will notice that the first eight bytes are arranged vertically but that the ninth appears immediately to the right of the first byte. In fact, if you change line 30 to read FOR I% = 0 TO 639 and delete line 50, which just waits for a keypress, you will see that the 640 bytes form a strip across the screen 80 bytes wide and eight bytes deep.

A mode 2 screen is made up of 32 such strips. Within each strip vertically adjacent bytes are consecutive—that

is, the number of any byte is one greater than the byte above. Since each strip is eight bytes deep it follows that the difference between horizontally adjacent bytes is eight. The difficulties arise when you want to put a sprite on the screen which will occupy parts of more than one strip.

There are a few ways of dealing with this problem and that will be the subject of the next article. The important point to appreciate here is that your character data should be organised in such a way that it reflects the organisation of screen memory. This ensures that you can then select the most efficient way of writing it to the screen. The method I have chosen means that instead of having to calculate the address of either each individual byte or each

PROCEDURES

580 to 630 PROCpntr(X%,Y%)

Uses Exclusive OR (GCOL3,7) plotting to draw the cursor. This ensures that it can be seen no matter what the background colour and that redrawing it in the same position will delete it.

640 to 720 PROCdraw(col%,X%,Y%)

This is the heart of the program. Apart from drawing CHR\$240—the representation of an enlarged pixel—in the chosen position and in the appropriate colour, this procedure passes parameters in lines 670, 680 to the main machine code routine, 'byte-number', and then CALLs it. A description of this routine appears below.

730 to 770 PROCwind-up

This is the error-handling routine. It can be deleted when you have de-bugged your program.

780 to 930 PROCsave

Sets up a parameter block starting at &3000 containing details of your data file—name, start address, finish address etc—and then calls OSFILE at &FFDD with 0 in A% and with X% and Y% pointing to the parameter block. This saves your data for you.

940 to 2920 PROCassemble

This sets up the machine code routines. In order these are:

980 byte-number

This routine has had parameters passed to it by PROCdraw. &88 contains the number along the X axis of the pixel to be altered—ie, its column number. The left-most pixel is number 0. &89 contains the Y axis number of the pixel—its row number. The top row is 0 and the bottom 23. The routine has two purposes. It calculates the position in the data table of the byte to be altered using the formula $\text{byte-number} = (X \text{ DIV } 2) * 8 + ((Y \text{ DIV } 8) * 8 * W) + Y \text{ MOD } 8$, where W is the width of the character in bytes and X and Y are the co-ordinates. The result is stored in &8F and &8D. The second objective is to work out in which 'strip' of screen memory the altered byte should appear. Possible answers are 0 for the first strip and 1 or 2 for the second and third strips respectively. These values are stored in the X-register (not to be confused with the X axis) and control the

operation of the routine 'pixad' starting at line 1690, which calculates the base address for a further routine 'store', which displays your character actual size as you design it.

1290 byte-value

PROCdraw has changed the dummy addresses (&8000 at lines 1320 and 1610) to the address of the start of the current data table. The byte to be altered is loaded into the accumulator. If the X axis number is odd then the pixel to be changed is a right-hand one, otherwise it is a left-hand one. Lines 1420 to 1490 or lines 1510 to 1580 filter out the old colour bits and replace them with those of the new colour, contained in &87.

1590 store

This places the new byte value in the correct position in the data table and also displays the new pixels on the screen.

1860 display

Displays designs across the top of the screen. Line 240 passes 3 parameters to this routine:

1. &70 Contains the number of the character
2. &71 X axis position (0 to 79)
3. &72 Y axis position (0 to 255)

The first part of the routine calculates the screen start address of each of the three strips for each character using the formula:

$$\begin{aligned} \text{strip 1} &= \&3000 + (640 * (Y \text{ DIV } 8)) + (8 * (X \text{ DIV } 8) * 8) \\ \text{strip 2} &= \text{strip 1} + 640 \\ \text{strip 3} &= \text{strip 2} + 640 \end{aligned}$$

Lines 2420 to 2490 search the address table starting at &12F0 for the low byte of the start address of the character data table. This is put into &88. A loop then increments the low byte by the block size—ie 8* width—the number of bytes to be written to each strip—contained in &12EF—and puts the results into &8A and &8C. The next loop takes the high byte of the character address and puts it into &89, &8B, and &8D. 'Mainloop' now reads from the data table and inserts it into the appropriate screen memory addresses, using the Y register to index.



THREE NEW PROGRAMS FROM MICROTEST

DAIRYFILE FOR DAIRY FARMERS

Keep on that economic line between over and under feeding!

Save time recording milk yield and calculating feed amounts!

Quickly decide feeding policy with the 'Monthly Calving Group' Performance Graph!

Print out a recording sheet with cows in numerical order. Print out graphs or tables of individual cows or Monthly Groups showing serving and pregnancy details, illness record, Calving Index, weekly and running total Margin over Concentrate. See at a glance cows due for serving, pregnancy diagnosis and drying off. Keep track of weekly total feed cost and milk sale price.

All this and more with DAIRYFILE.

Predict cow or Monthly Group total lactation yield. Compare with Standard Lactation Curves. All old data preserved—compare Monthly Groups over the years. Which is the most profitable month?

Find out with DAIRYFILE—for up to 200 lactating cows.

£69.00 inc. VAT (disc only) + p&p 50p

2 x 40 Track Drives Required or 1 or more 80 Track Drives. Please state which when ordering.

SATAN'S CHALLENGE or (Nevil Rides Out)



A Black Magic Adventure

Dare you take up the challenge laid down by the most evil and sinister of all beings... the devil himself. If you do you will find yourself alone and at the mercy of the twisted fancies and whims of a cold and calculating mind.

Occult forces are threatening the lives of those near and dear to you. Their only salvation rests in your hands but in accepting the challenge your own existence is put in severe peril.

In taking up the challenge you have to find The TALISMAN and locate a pentagram which then has to be prepared for the final rite. In the meantime dark forces will be opposing you making a difficult task almost impossible.

Do not allow yourself to be lulled into a sense of security for it will be short lived. Many have gone before only to swell the ranks of the damned.

This is the latest adventure from the stables of Microtest and has been written with the acclaimed features of other adventures in mind eg save facility, quick response, simple but extensive commands, a mixture of logical and friendish problems to solve.

Be warned this is an easy adventure to get into but devilishly difficult to end.

Cassette £7.95 inc. VAT Disc £9.45 inc. VAT +p&p 50p Disc 40 or 80 Track.

MICROTEST FONT ROM.

This exciting new ROM from Microtest will enable you to get all sorts of new characters and fonts from your BBC Computer. Once you have produced your masterpiece on the screen, all you have to do is use the inbuilt screen-dump utility to produce a hard copy on to paper.

Typing '*HELP FONTS' gives a list of available fonts and the blocks of characters which they replace.

Available fonts are:

- *Accents Accents and miscellaneous.
- *Block Small capitals.
- *Data Like the bottoms of cheques.
- *Greek It's all Greek to me too!
- *Joined Standard capitals with joined up lower case.
- *Maths A mix of until now unobtainable Mathematical symbols.
- *Miscellaneous A few oddities which often are very necessary.
- *Thick Thick text (for MODEs 0&3) to enhance 80 column mode.
- *Thin Thin text (for MODEs 2&5) which makes modes 2 & 5 much more readable or perhaps "READABLE".
- *Vertical For labelling graphs.

The ROM has a dump facility which will produce a screen dump of any MODE for 0 to 6 on an Epson, Star printer, CTI CP80 or MT80.

The ROM uses absolutely NO user memory and can be used with word processors etc. as well as normal BASIC programs.

£17.50 inc. VAT + p&p 50p

Microtest Starstick ROM & Joystick Package

Now available the Starstick ROM and Joystick. This comes in three forms:



Enables you to use our joysticks even on programs that do not offer joystick capability.

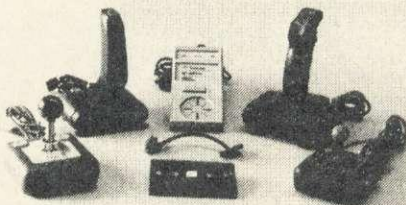

- (A) The Starstick ROM and Quickshot I Joystick
Price 17.95 + VAT = 19.84
- (B) The Starstick ROM and Quickshot II Joystick
Price 19.25 + VAT = 22.14
- (C) The Starstick ROM and patch lead, choose your own Spectrum/Atari style joystick
Price 15.25 + VAT = 17.54

Post and Packing £1.00 inc. VAT per item

This enables you to plug the Rapid action self centring joysticks until now only available for the Spectrum/Atari/CBM machines into the user port of the BBC. Model A users please note NO ANALOGUE INTERFACE REQUIRED.

Disc Users Note—pressing BREAK, SHIFT-BREAK or CONTROL BREAK does not modify or destroy the STARSTICK software so Disc Users please feel free to Boot!

The software patch provided in the ROM is interrupt driven and adds the following commands to your computer.

- * STICK turn on the STARSTICK ROM
- * NSTICK turn off the STARSTICK ROM
- * SETSTICK set up joystick to users spec
- * SAVE "NAME" 140 160 saves your user-key protocols
- * ADVAL emulate standard analogue joysticks
- * PAUSE define key to Freeze game
- * NPAUSE turn off ability to freeze game
- * "NAME" predefined key protocols set up for software houses programs
- * HELP KEYS displays currently selected key protocols
- * REPEAT enables auto-repeat fire
- * NREPEAT disables auto-repeat fire

DEALER ENQUIRIES
and
EXPORT ORDERS
WELCOME

available from

MICROTEST LTD

18 Normandy Way, Bodmin, Cornwall PL31 1EX

Telephone: 0208 3812

OR ANY GOOD DEALER

Large picture shows BBC Computer System and a Quickshot II Joystick. Small inset just a few of the joysticks that will work with the patch lead. Screenshots by kind permission of SUPERIOR SOFTWARE



horizontal row of bytes, you need only calculate the start address of each strip to be written to.

You may be relieved to know that the first program does all the calculation of byte values and organises them into tables for you. All you have to do is the creative bit.

How to use the program

Now for the sprite design program in this issue. When you run it you'll be asked how wide in pixels (8 to 20) you want your character to be. Having selected this you will see a box within which you design your character, at approximately four times magnification. As your design progresses it will also be shown actual size to the right of the box, while all your previous designs are shown actual size across the top of the screen.

The keys to control colour are displayed on the left of the screen. They correspond to the hex number of each colour, so pressing 1 gives colour 1 and pressing F gives colour 15. The list of colours is itself colour-coded so you don't have to remember numbers or keep referring to the *User Guide*.

To change the colour of any location just move the cursor over it, using the cursor control (arrow) keys, and press the appropriate colour key. You can make any alterations you want to the current design at any time.

When you've finished a design just press the TAB key. You will then be asked whether you want to do another design or stop. You can have up to six separate designs per session, although for reasons that will become apparent next month, these six designs are treated as being eight designs. Character 2 is the same as character 0 and character 6 is the same as 4.

When you have either filled up available memory or have decided to stop you'll be given information on the number of characters defined, the address of the data in memory, and the location of the table of addresses of the start of each character's data block. You don't have to make a note of all this information - it's just to reassure you. You will then be asked if you want to save the data. If you don't, the program finishes. If you do, you are asked what you want to call the data file.

After this you are given an opportunity to get your tape ready or insert the appropriate disc and then the data is saved automatically. It doesn't matter whether you're using cassette or disc.

The filing system in use is important, however, in that it affects the default setting of PAGE. The program *must* be loaded and run with PAGE set at &1900. Disc users will probably have PAGE set

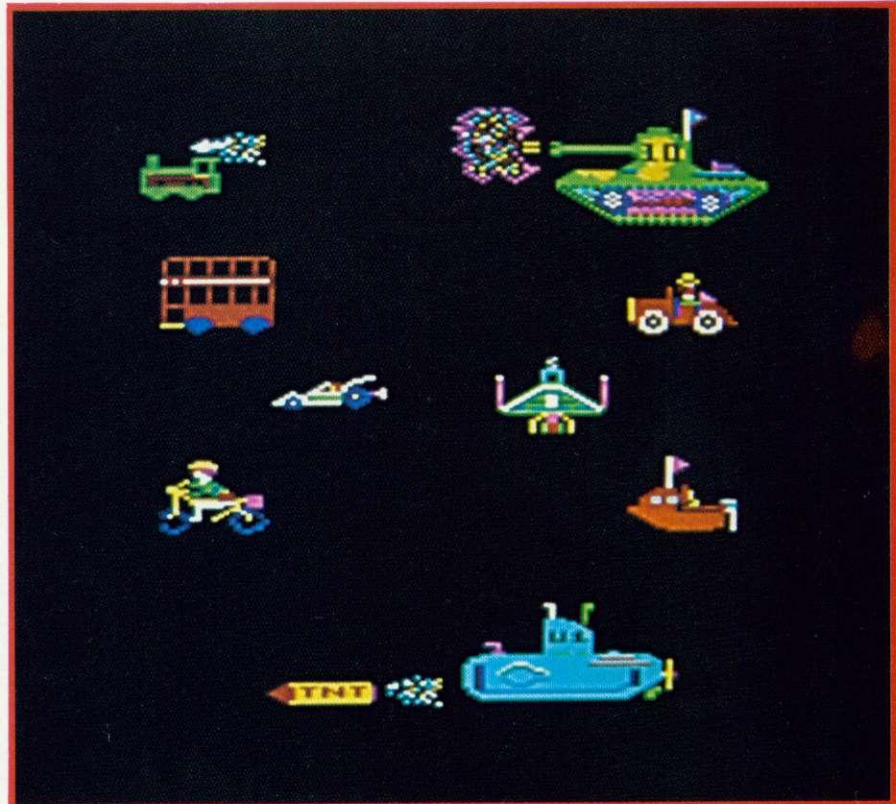

Some of the spritely characters from Harry Sinclair's portfolio. By combining four 'quartered' designs, such as the tank and submarine, a larger character can be created, and movement can be suggested with the use of flashing colours

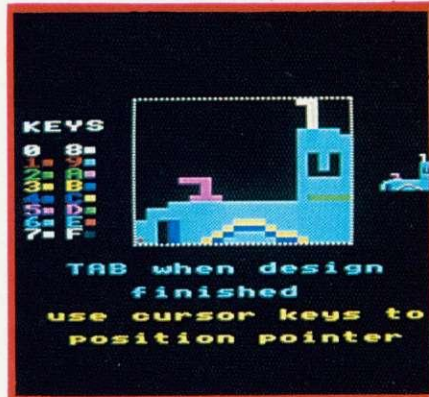

Designing a multi-sprite character. Stage 1: the conning tower takes shape ...

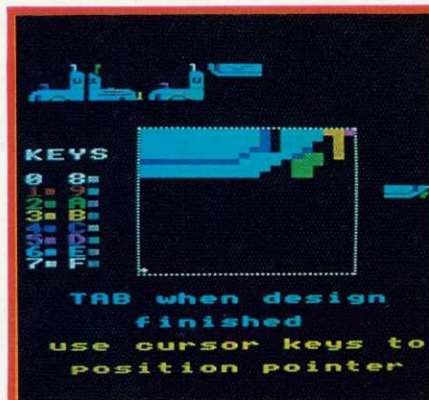

... Nearing completion. The last section is put together. The other quarters are shown 'saved' at the top for reference, awaiting assembly of the complete model

to this anyway but machines using cassette or those fitted with Econet will have to have their default setting altered by typing in PAGE = &1900. If you have Econet you'll also have to type in ?&224 = &A6 to disable it before loading, otherwise the program may be corrupted, since it occupies Econet workspace. It is also advisable to add a line 0 as follows:

```
0 REM *****
```

When the disc drives are used on an Econet machine bytes &1905 and &1906 seem sometimes to be corrupted even when Econet is disabled, but this extra line will make that unimportant.

Next month I'll give you a number of extra procedures that let you edit previously designed sprites, produce 'clones', mirror images and so on. It isn't possible to include them here as the program only just fits into available memory as it is. However, removing PROCassemble and loading the machine code separately should provide enough room for these additional facilities.

Remember to set PAGE to &1900 before you type the program in and save it before you attempt to RUN it, just in case PROCassemble runs amok and starts assembling code all over your hard work. Better still, you could get this month's cassette and save yourself a lot of typing.



A STAR IS BORN



PRESTEL, MICRONET, BBC to BBC file transfer, Terminal Emulation.

Commstar is unique and complete, a total solution. Imagine, a single Eprom-based package of sophisticated communications software that caters for all your requirements.

Imagine Commstar

Take for example British Telecom's Prestel service offering access to a multitude of up-to-the-minute information pages, world news or weather and much more. Instant access to Micronet 800 with many free programs that can be downloaded in seconds, free advice and news. Expand your horizons and find out just how versatile our computer can really be!

How many times have you wanted to get a copy of a program to a friend or a business colleague, quickly? With Commstar you can transfer a file of ANY type, between two BBC's (which may be thousands of miles apart), in the space of a phone call.

It really is that simple!

Commstar is 'intelligent'. It offers many advanced features to ensure simple and effective communication with the remote system.

Consider the following features:

Prestel Mode

Prestel mode features full colour Prestel graphics including double height and flashing characters. Full Telesoftware capability is offered allowing the many free programs offered by Micronet 800 to be downloaded into your computer. Pages of particular interest may be 'marked' for later retrieval and display. Page images may be copied and saved to a file on the current filing system.

Terminal Mode

In terminal mode all input may be copied into a buffer in memory or spooled directly on to disc. Full control over buffered data is provided allowing it to be listed to screen or printer, sent to the RS423, saved to or loaded from the current filing system (including TAPE).

Commstar allows full configuration and easy control over the protocols used. Send and receive baud rates, word length, parity and number of stop bits are selected from a simple table of options.

When in chat mode (80 or 40 column), characters transmitted by the host will be displayed on the BBC screen and characters typed on the BBC will be sent to the host.

Commstar allows ANY type of file (not just ASCII) to be transferred safely using XMODEM protocols. In fact, four individual methods of transmission are provided for within Commstar giving great flexibility.

Using a disk based 'emulation file' Commstar can be configured to emulate virtually any terminal type including VT100, within the capabilities of the BBC.

In addition to the above, most MOS commands can be executed from within Commstar - errors are trapped by Commstar's own error-handling routines and an optional elapsed time clock may be displayed. Data filter, Local Echo, Auto-line-feed, printer on/off and XON/XOFF protocols may be toggled in or out by a single key press, extensive use being made of the function keys.

Finally, Commstar may be fitted into any of the sideways ROM sockets and is provided with a comprehensive manual.

£34 inc. VAT & Carriage.

A revolutionary new approach to program development aids.

Toolstar is a powerful new utility Rom that will open up a whole new world for BBC micro users.

Toolstar adopts a revolutionary new approach to program development aids. It has been designed specifically to assist both Basic and Machine code programmers by providing an integrated set of powerful building blocks which rapidly become an indispensable complement to the built in facilities of your BBC micro.

This package contains the Toolstar firmware in Eprom and a very comprehensive manual (over 150 pages), containing many examples and illustrations to help you make the best use of Toolstar's exciting capabilities.

Toolstar sheds new light on your BBC micro

Toolstar, being Eprom-based will be permanently resident in your computer allowing all of its commands to be immediately available. It is 'transparent' to both the user and the operating system: once a command has been executed, control is returned to Basic, or whichever ROM had control prior to the command.

Full error handling has been incorporated and for new users there are full help menus describing each command and its syntax.

Powerful building blocks for Basic programmers?

Within Toolstar there are 22 commands, 8 of which operate between PAGE and TOP i.e. on the current Basic program or Basic programming environment. These commands obey standard Basic command syntax rules.

Reveal the deepest secrets of your discs

Toolstar allows the operations of Formatting, Verifying, reading or writing a disc sector to be carried out very simply from Basic, i.e. all the necessary building blocks required to develop a comprehensive set of disc utilities, simply and effectively.

Lost your memory? - No more amnesia with Toolstar!

In addition to the commands described above there are 9 commands which operate on the whole of the BBC's memory and are designed to complement the BBC's built-in assembler. These include a full feature disassembler and memory dump, each with forward and reverse scrolling.

If this is not enough Toolstar can be Extended!

There are three help menus on Toolstar which may be obtained by typing HELP TOOLS, *HELP MCODE or *HELP EXTEND. The third option menu will initially display the following:

*HELP EXTEND

EXTEND <RAM add>

i.e. typing 'EXTEND <address>' will allow the user to extend the facilities of Toolstar with routines which are supplied by himself. The manual describes fully how this operation is carried out and illustrates it with several examples.

In the future such utilities will be made available on disc and cassette from Pace, thus allowing a comprehensive library of utility programs to be built-up.

£34.00 inc. VAT & Carriage.

**Access and Barclaycard
Dealer Enquiries welcome
Send for more information to:**



**92, New Cross Street,
Bradford BD5 8BS.
Telephone: 0274 729306
Telex: 51564**

TCL-PANASONIC

3" Disk Drive – The Choice . . .



Special!

Twillstar Computers Offer

INGENUITY, DURABILITY, COMPATIBILITY . . .

This is the Twillstar (TCL) Panasonic 3" Disk Drive which features the ingenious dual-sided cartridge protected disk, 200K (100K per side). Ideal for use in education and other environments where rough use is envisaged.

Compatible with all disk interfaces, comprehensive manual and utilities on either disk or EPROM.

DESIGN, COLOUR, SIZE . . .

This 3" Disk Drive is totally housed in a high stability aluminium two piece casing, with a light plastic face, and a unique automatic steel shutter which protects the disk surface. A highly sensitive injection key allows easy insertion and extraction of your diskette. The case is finished in a tough coating of beige to match the colour of your BBC.

The size is a compact 160mm length x 90mm wide x 55mm deep.

FEATURES, CAPACITY, USAGE . . .

This 3" Disk Drive uses 3" diskettes which are handled like a cassette, 100K each side of the diskette, giving you 200K. It can be purchased with cables, formatting disk and comprehensive manual. Ready to plug in and use, and remember, it is compatible with all known disk interfaces for the BBC Micro – and no extra power supply is required. The PANASONIC TCL (TWILLSTAR) 3" Disk Drive carries a 12 MONTH PARTS AND LABOUR GUARANTEE!

DISKETTES, SPECIFICATIONS, ACCESS . . .

You may use any 3" Diskettes, Maxell, Panasonic, Hitachi etc; these are cassette like cartridges engaged in rigid plastic with the disk surfaces protected by a stainless steel shutter which is automatically opened and closed by the Disk Drive. Track to track access time is three ms. Data transfer rate 125 kbs-1. Dual double sided Disk Drives give 1 megabyte of on-line storage.



Twillstar Computers Limited

17 REGINA ROAD, SOUTHALL, MIDDLESEX UB2 5PL TEL: (01) 574 5271

YOUR SPECIAL PRICES!

3" TCL/PANASONIC DISK DRIVE
Offer Price £99 + VAT = £113.85
(includes Manual)

CABLES AND FORMATING DISK
Offer Price £19 + VAT = £21.85

3" PANASONIC DISKETTES
Special Offer of £4.50 each

HOW TO ORDER

To take advantage of this special offer all you have to do is fill in the coupon below with your name and address, enclosing your cheque/P.O. made payable to Twillstar Computers Ltd; if you are a Barclaycard or Access card holder, please use the coupon and post to:

TWILLSTAR COMPUTERS LTD, 17 REGINA ROAD, SOUTHALL, MIDDLESEX

**Post to: TWILLSTAR COMPUTERS LTD,
17 REGINA ROAD, SOUTHALL, MIDDLESEX.**

Please send me (No.) _____ 3" TCL Panasonic Disk Drives, at £113.85 inclusive of VAT, plus £3.50 post, packing and insurance.

Also send me (No.) _____ Cable(s) for (state your micro) _____ and Formating Disk and Manual at £23.00 each inclusive of VAT.

I would like to take advantage of 3" Diskettes by PANASONIC please send me (No.) _____ at £4.50 each inclusive of VAT.

I enclose my cheque/P.O. for £ _____

I prefer to use my **ACCESS/BARCLAYCARD**
(delete whichever not applicable)

Card No. _____

Signature _____

Name _____

Address _____

Credit cards valid if signed by card holder. Address above must be the same as the card holder.



SPECIAL OFFER!

Order both directly from us and deduct £1 from each.

TWO SENSATIONAL NEW RELEASES FROM SUPERIOR SOFTWARE

**BBC
MICRO**



STAR STRIKER (32K)

£7.95

A multi-stage arcade-style game in which you take control of a 3-stage rocket equipped with 4 side lasers and a central laser cannon. Not only must you defend the rocket against the 6 types of circling alien, and avoid the asteroids and fireballs, but you must also attempt to dock the separate stages of the rocket together. Stunning graphics, sound effects, introductory tunes, hi-score and rankings. Another excellent program from Superior Software. (KEYBOARD or JOYSTICKS)

OUR PROGRAMS ARE NOW AVAILABLE FROM OVER 1000 OUTLETS THROUGHOUT THE UK AND OVERSEAS. SEE YOUR LOCAL DEALER!

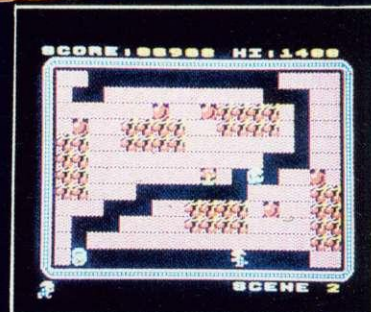
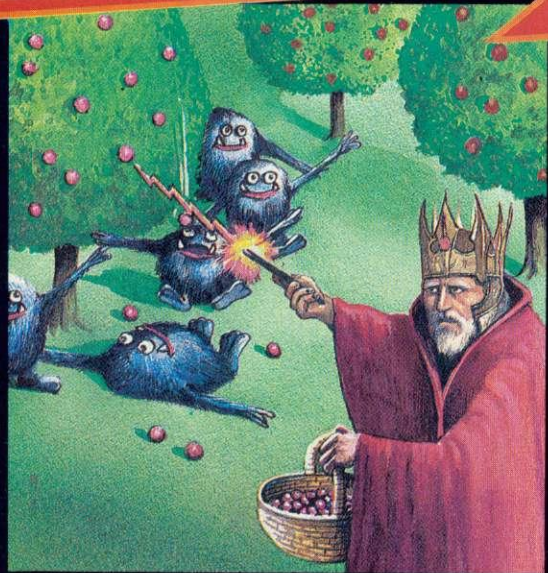

MR. WIZ (32K)

£7.95

From the author of Percy Penguin, Mr. Wiz is a fast-action multi-scene game. Guide Mr. Wiz around the garden to eat the cherries whilst avoiding the evil gremlins. The gremlins can be killed by dropping apples on them or by throwing the crystal ball. Extra points can be gained by eating the magic mushroom, but beware... this is the home of the gremlins and makes them permanently furious! Sound effects and tunes, hi-score, rankings. Superb arcade-style action. (KEYBOARDS or JOYSTICKS).

WE PAY UP TO 20% ROYALTIES FOR HIGH QUALITY BBC MICRO AND ELECTRON PROGRAMS



SUPERIOR SOFTWARE LTD.

Dept. AU7, Regent House,
Skinner Lane, Leeds 7
Tel: 0532 459453

OUR GUARANTEE

- (1) All our software is available before we advertise.
- (2) All our software is despatched within 48 hours by first-class post.
- (3) In the unlikely event that any of our software fails to load, return your cassette to us and we will immediately send a replacement.

Intersoft

Utility Toolkit in ROM for the BBC Micro

A BRIEF SPECIFICATION

- *FIND — find any string or keyword in a Basic program
- *REPLACE — a string or expression with one of ANY length
- *LVAR — decimal or hexadecimal variable list
- *CRUNCH — compacts program into multi-statement lines
- *DEREM — one of three less drastic compacters
- *EXPAND — open up a gap in the line numbering
- *LSTERR — automatic error line listing ready for editing
- *MERGE — one programme to another, with auto renumbering
- *REPAIR — a 'Bad Program' and list suspect lines in it
- *SHIFT — a Basic program up or down to any page
- *KEYS — display defined key contents in editable form
- *MEMLOCS — print all pseudo-variables and memory free
- *LOCK — make a software protected cassette tape
- *PDUMP — a large scale Epson printer dumper with border
- *REMOVE — as Basics' delete but done instantly

Plus ten more useful utilities for program development and debugging. Compare these facilities and our price, then decide on the Intersoft U-TOOLS system.

Needs OS 1.20 (and a spare ROM socket)

£26.95 (Inclusive of VAT and P&P)

Send cheque or P.O. to INTERSOFT

26, Netherfield Road, Sandiacre, Nottingham. NG10 5LN

Trade enquiries welcome

UK's LOWEST PRINTER PRICES!

PRINTERLAND



ORDERED TODAY - DELIVERED TOMORROW
DOT-MATRIX

EPSON RX 80	£189.95
EPSON RX 80 F/T	£219.00
EPSON RX100	£329.00
EPSON FX 80	£317.00
EPSON FX100	£425.00

DOT MATRIX PLUS NEAR-LETTER QUALITY

CANON PW1080A	£249.00
---------------	---------

DAISY-WHEEL

JUKI 6100	£345.00
EPSON DX100	£356.00

ACCESSORIES

WORDWISE	£32.00
PAPER (2000 Sheets)	£12.00
BBC/PRINTER CABLE	£10.95

COPYALL DISK

<ul style="list-style-type: none"> ● Copies ALL protected disks inc. tape to disk utilities. ● Best on the market ● Copies from original to your blank disk 	£10.25
--	--------

Educational, G'ment plus O'seas Orders Welcome

Please add 15% VAT. Delivery Printers £10.00. Paper £3.00. Other 50p
Printerland, Unit 27, Estate Buildings, Railway St., Huddersfield HD1 1JP

TEL HUDDERSFIELD (0484) 514105

Better by definition...

Phillips V7001 12" Tube
High Resolution Computer Monitor

**Twillstar Computers
Offer £75 INCLUSIVE!**

Size:
345mm width x 300mm depth x 302mm height



This special V7001 Phillips monochrome computer monitor comes direct to you from Twillstar Computers Ltd at the exceptional price of £75 inclusive of VAT. Twillstar Computers Ltd have negotiated with Phillips to bring you this 12" Tube high resolution monitor which has been specially designed to display alphanumerical and graphic information, generated by home and personal computers. It offers compatibility with various types of computers, it accepts composite video signals (CVBS) as well as RGB, synchronisation and sound signals! The monitor provides a clearly legible display with a maximum of 80 characters per line and 25 lines per display. The display format is full screen 250 x 200mm. To reduce eye fatigue the picture tube has undergone a special anti-glare treatment. The monitor also features a two position, adjustable stand.

Just look at the features!

1. 12" high resolution picture tube.
2. Two position adjustable stand.
3. Anti-glare treated screen.
4. P31 green phosphor.
5. CVBS input connections.
6. RGB and synchronisation and sound input connection.
7. Sound input 0.3 watts.
8. 18MHz Bandwidth.
9. 2000 character display control.
10. Compatible with home and personal computers.
11. Precision deflection unit for low geometric distortion.

And of course, exterior controls allow you to switch on/off volume, brightness, contrast, vertical size, vertical hold and horizontal size. This unique specially designed monitor measures 345mm width x 300mm depth x 302mm high. Order now while stocks last!

TCL

HOW TO ORDER
All you have to do is fill in your requirements on a piece of paper with your name and address enclosing your cheque/ P.O. made payable to TWILLSTAR COMPUTERS LTD. If you are a Barclaycard or Access card holder, please use coupon and post to address below.
Please allow 14 to 28 days for delivery.

Twillstar Computers Limited

17 REGINA ROAD, SOUTHALL, MIDDLESEX UB2 5PL TEL: (01) 574 5271

SLOGGER SOFTWARE

MACHINE CODE GAMES FOR BBC 'B', ELECTRON, SPECTRUM 16/48K

A MAZE IN SPACE

Use Joysticks or Keyboards to navigate your Starship to the planet surface and then into the maze below. Having been told in which section of the maze your target is hidden, your objective is to seek out and destroy it to complete a mission. Beware of the numerous alien defence systems. Two levels of difficulty! Horizontal and diagonal scrolling!
How many missions can you complete?

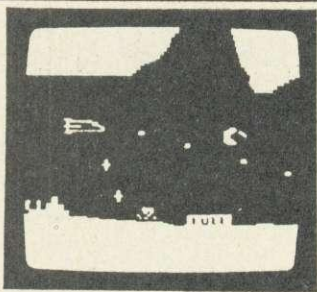

Available now	Cassette	Disc
BBC 'B'	£9.95	£11.95
Special Offer		
Dogfight and A Maze In Space together		
	Cassette - £14.95	Disc - £16.95

Please state 40 or 80
Track if disc

DOG FIGHT

Still undoubtedly the most exciting 2-player game available. The objective is to fire sufficient shots into your enemy aircraft to force it to explode. Eight levels of difficulty. Sun, moving cloud, lightning, ground all provide real combat environment. Can you beat your friends?

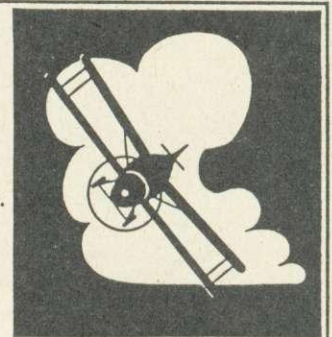

Available now	Cassette	Disc
BBC 'B'	£9.95	£11.95
Electron	£7.95	n/a
Spectrum	£5.50	n/a

All prices include
VAT and postage

SLOGGER SOFTWARE

215 BEACON ROAD
CHATHAM, KENT

Tel: (0634) 811634



ADD 40 COMMANDS TO BBC BASIC WITH ONE ROM

GRAPHICS

SCALE is a powerful and totally flexible statement that allows the user to take control of the scaling of the screen. Integers, real numbers and variables can be used. **ROTATE** is used to 'rotate' the axes about a point and by an angle both defined by the ROTATE statement on a scaled screen. **CIRCLE** and **ELLIPSE** allow a multitude of shapes to be drawn using a single statement, including: any regular polygon, circles, arcs, solid sectors, triangles, squares, etc. **FILL** is used to 'fill' a previously drawn area, with **CFILL** setting the colour/pattern/shade within pre-drawn bounds. **TRANS** is used to translate the scaled area across the screen by the use of cartesian co-ordinates, subsequent graphics commands making use of the now displaced scaled area.

Plus: SMOVE, SDRAW, SPLOT and UNSCALE.

4
IN
1

LLIST can be programmed, unlike LIST, and under the User's control, multiple statement lines can be split up into their component parts allowing for greater ease of reading. **LOGOTO** is similar to the GOTO statement but more powerful in that it enables the user to jump to 'labelled lines' allowing for neater and more readable programmes. **SORT** allows the user to sort all or part of a string array into alphabetical order using a single statement. Invaluable for data processing. **SETWIN** and **WIN** allow the user to define, using SETWIN, and display, using WIN up to seven complete windows on the screen. The user being able to select and return to previously de-selected windows at will, the cursor maintaining it's last used position within that window.

Plus: OPT, POPFOR, POPGOS, POPREP and ADDCOMM.

GENERAL

Compatible with: Acorn DFS, Amcoff(Pace) DFS, Watford DFS, Wordwise, Disc Doctor. Model B, BASIC 1 or 2, OS 1.20

ADDCOMM

Plus: *HELP displays the full syntax of all commands. Price includes a detailed ring-bound User Guide.

LOGO

LMOVE is used to position the LOGO cursor, usually used prior to further LOGO statements. **ANGLE** is used to set the intended direction of the LOGO cursor, the angle being described in degrees. **ADVANCE** is used to move the cursor in the direction as set by ANGLE by the distance described in the ADVANCE statement. **TUR** gives the cursor a new direction by turning it a certain number of degrees anti-clockwise from its previous direction. **FEN** defines the kind of trail left by the LOGO turtle using the internal plot codes. **LCIRCLE** and **LELLIPSE** are the LOGO equivalents of the similar enhanced graphics commands, the shape centre being the current LOGO cursor position. **LPOS** is used to return the position of the LOGO cursor from a SCALEd screen.

These commands are unlike those on any other ROM, since they are used in exactly the same way as the standard BASIC commands - i.e. any numeric/string expression, multi-line statements, access to any variable, and, of course no stars!

£28

includes V.A.T. post and packing.

NOW AVAILABLE FOR

ELECTRON
WITH ROM BOARD

CHAR is a simplified 'character' designing facility using an enlarged grid that enables the user to quickly and easily construct or alter graphic and pseudo-alphanumeric characters. **COMPACT** is used to reduce the size of all or part of an existing program by intelligently appending lines together. **FIND** is used to search all or part of a program to find any desired character or set of characters. **GREPL** and **SREPL** are two related commands that enable the user to replace a character or group of characters with any other character or group of characters, under total control of user. **LVAR** is used to list all, or alphabetically selected, variable names currently within memory. **VERIFY** is a simple command to confirm that a copy to tape or disc is exactly the same as the original program in memory.

Plus: MEM, GOODPROG, KILLREM and FKEYS.

FOOLISH

VINE MICROS, MARSHBOROUGH,
SANDWICH, KENT. CT13 OPG.
(Or send stamp for Brochure.)

The Original "NEWARK"

TV/RGB Monitor

It's a 14" remote control Grundig T.V.!!

(ORIC
ATMOS)

It's an RGB computer monitor!!
(BBC/ACORN)

It's £249.94 incl. VAT — complete package!!

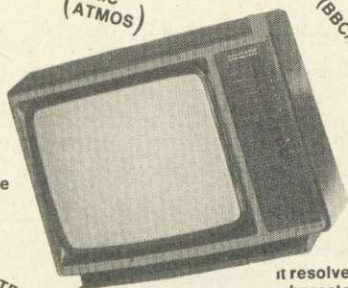

(MSX)

QL (almost)

(ELECTRON)

it resolves 80 characters!!

The package:

£249.94 for a remote control 14" TV with a computer lead — delivered to your door — including VAT (we even fit a mains plug!) and carriage.

We have a **Large** range of **Grundig** models from **14" to 26"** with or without Teletext.

Contact Elaine for an up to date leaflet package.

NEWARK VIDEO CENTRE LTD.

108 London Road, Balderton, Newark, Notts.
0636 71475 to order by Access or Visa
Mon-Sat/9 am-6pm

DAISY STEP 2000 Daisy Wheel Printer

Twillstar Computers Offer £259 INCLUSIVE

Telephone
Orders
574 5271



*FREE CABLE
*FREE PAPER

... At the special price of £259 inclusive of VAT and Post, Packing and Insurance, this is indeed a unique opportunity to own an amazing flexible Daisy Wheel Printer!

Just look at the features!

- | | |
|--------------------------------|---------------------------------|
| 1. 18 CPS | 8. Bold and shadow printing |
| 2. Bidirectional | 9. Sub & superscripts |
| 3. Logic seeking | 10. QUME compatible ribbons |
| 4. Proportional tracing | 11. QUME compatible daisywheels |
| 5. Wordstar compatible | 12. 4 level impression control |
| 6. 13" platen - 12" print line | 13. Prints original + 4 copies |
| 7. Auto underscore | 14. Low noise |

This extremely attractive printer comes complete with free printer cable and 500 sheets of test run paper — just to make sure you get everything running smoothly!

HOW TO ORDER



To purchase this Daisy Step 2000 Daisy Wheel Printer, simply write your name and address on a piece of paper, and post to us enclosing your cheque or P.O. made payable to Twillstar Computers Ltd. If you are an Access/Barclaycard holder, simply use the telephone to place your order.

Twillstar Computers Limited

17 Regina Road, Southall, MIDDLESEX, UB2 5PL. TEL: (01) 574 5271



ACORN
APPROVED

MUSICSOFT

MUSIC SPECIALISTS FOR THE 32K BBC MICRO

★ THE SYNTH ★ (O.S.1.0+)

"A very flexible and inventive program that's highly recommendable." (Dr David Ellis, E&MM, Oct 83). This 'synthesizer' program has features which to our knowledge are unique. ALTER RHYTHM. The rhythm of a recorded melody may be altered by tapping on a single key. REPEAT. No need to play a phrase twice, great saving in space. REAL TIME PLAYING. With alteration of volume, envelope and octave pitch as you play a note. EDITING. Back and forwards whilst hearing the tune. INPUT. May be hesitant or in correct time. TIDY. 'Cleans up' inaccuracies of input on demand! NUMBER OF NOTES. From 3000 for 1 channel to 1000 for 3, etc. Plus all the other synthesizer programs do PLUS. IE sophisticated envelope editing (very easy), larger keyboard used (TAB to ↓ cursor). No secrets, user transparent. This is the program for the experimenter who wants to make HUMAN music rather than perform mathematical finger dexterity exercises. THE SYNTH. Cassette & instructions only £8.75 inc. P&P.

★ KEYBOARDS ★ (O.S.1.0+)

5 programs to turn your BBC into 5 real-time keyboards. 1.3 simultaneous voices (in Basic for easy understanding) 2. Single voice M/C with Pitch Bend. 3.3 simultaneous voice M/C with Envelope control built in. 4. Single finger Chord organ ranging over the whole keyboard. 2 variations for each chord. 5. Chord organ 2 with different chord configuration. These are all separate programs designed for you to use as they are or in your own programs. KEYBOARDS cassette & instructions £5.75 inc P&P

★ MUSICTOOLS ★ (all O.S.)

"Musicsoft also produce an excellent 'Musictools 1' cassette ... all in all, rather good value" (E&MM, Oct 83)
Five music utility programs on one tape.
Tune Generator with dynamic graphic Keyboard & Stave display. Envelope Command Explorer (Very easy to use), Musical Symbols Graphic routine. Simple single line organ with sophisticated controls. Over 60 procedures for you to use in your programs already in working programs.
MUSICTOOLS 1 cassette & instructions £5.75 inc. P&P.

★ PIEMAN ★ (all O.S.)

"The best version of Simon I've seen, it goes so much further than most" (Quote by a rival software firm!) Recommended for Primary & Middle Schools.
Not as simple as Simon! It develops into a fun set of ear cleaning and musical concentration games.
PIEMAN cassette & instructions £5.75 inc. P&P.

ALL PROGRAMS TRANSFER EASILY TO DISC.
Cheques and official orders to:
MUSICSOFT, Dept N, 12 Fallowfield, Amptihill, Beds.
Telephone: 0525 402701

All 4 programs on 40 track disc - £26.00

THE BBC MICRO SOUND SYSTEM MICROVOC

As supplied to Schools & Colleges

SYSTEM INCLUDES:

Speakers, Volume control, jack sockets and all connections (assembled) plus Buzzgo to eliminate the infernal B.B.C. buzz.

Easily fitted with no drilling, soldering or cabinet modifications £23.00 inc VAT and p & p

MICROVOC WITHOUT SPEAKERS £15 inclusive

Micro Box external socket also allows you to connect directly to your hi-fi system - now you can rattle the windows with Planetoid etc. . .

MICROVOC IS IDEAL FOR SPEECH
SYNTHESIS OR COMPUTER PRODUCED
MUSIC

MICRO-ADVENT

Ashlyn House, 113 Writtle Road, Chelmsford, Essex.
Tel: 0245 59708

LISP for Micros

Steve Oakey

LISP is important in artificial intelligence and robotics. Assuming that you can already program in either BASIC or Pascal, this book starts you off with simple examples, gradually developing your expertise to the point where you can understand and use the advanced facilities of LISP. It introduces and explains programming in LISP using normal iterative methods, recursion and LISP interpreter. Finally, the book deals with program design and development in LISP.

208 pages £7.95 Softcover

Recently published:

Artificial Intelligence in BASIC by Mike James

Coming shortly:

LOGO for Micros by Martin Lesser

Newnes Technical Books
Borough Green, Sevenoaks, Kent TN15 8PH



UNBELIEVABLE SAVINGS

** COMPUTERS **

		EX VAT
APRICOT	256K 315x2 MONITOR	£1425.00
APRICOT	256K 720x2 MONITOR	£1625.00
APRICOT	Xi 256k 5MB MONITOR	£2175.00
APRICOT	Xi 256k 10MB MONITOR	£2295.00
APRICOT	Optional 12in MONITOR	£220.00
CIFER	9000 Multi User 21MB	£5095.00
COMMODORE	8250 DISK DRIVE	£785.00
COMMODORE	8296	£695.00
COMMODORE	SX-64 PORTABLE	£675.00
COMMODORE	64	£152.17
COMMODORE	DISK 1541	£165.21
COMMODORE	IBEK PARALLEL INTERFACE	£59.50
COMMODORE	1530 C2N CASSETTE	£32.00
COMPAQ		£1895.00
EPSON	QX10	£1600.00
KAYPRO	II	£945.00
KAYPRO	10MB	£1995.00
OLIVETTI	M20 160KB 2x320KB Drives	£1295.00
OLIVETTI	M24 128KB 2x360KB Drives	£1658.00
OLIVETTI	M24 128KB 10MB Hard Disk	£3315.00
OSBORNE	I	£1175.00
SAGE	II & IV	POA
SANYO	MBC 555 128K 2x160K Drives	£795.00
SIRIUS	256K 10MB	£2850.00
SIRIUS	256K 2.4MB	£2095.00
SIRIUS	128K 1.2MB	£1545.00
SIRIUS	Memory Expansions from	£222.00
SIRIUS	Express Accelerator Boards	POA
PLUS 5	External Hard Disk Drives	POA

** VDU's & TERMINALS **

CIFER	T4	£760.00
HAZELTINE	ESPRIT Fixed Keyboard	£395.00
QUME	QVT 103(VT100 VT131)	£695.00
TELEVIDEO	910	£489.00

** SOFTWARE **

ALL MAJOR SOFTWARE PROGRAMS SUPPLIED AT LOW COST

Plus:

Not only do we offer top quality products at low prices. We also support and develop Software with the assistance of our long established software dept.

** MATRIX PRINTERS **

		EX VAT
ANADIX	DP-6500 500cps	£2019.00
ANADIX	WP-6000	£1808.00
BROTHER	EP44	£199.00
BROTHER	HR5	£129.00
CANON	PW1080A 160cps (NLQ)	£279.00
CANON	PW1156A 160cps (NLQ)	£339.00
EPSON	RX 80T 100cps	£195.00
EPSON	RX 80F/T 100cps	£220.00
EPSON	FX 80 160cps	£324.00
EPSON	FX 100F/T 160cps	£430.00
EPSON	LQ 1500 200cps (NLQ)	£895.00
HONEYWELL		POA
MANNESMANN	MT80 80cps	£199.00
MANNESMANN	MT180 160cps (NLQ)	£590.00
MANNESMANN	PINWRITER	POA
NEC		POA
NEWBURY	DRE 8850 300lpm	£2095.00
NEWBURY	DRE 8925 240cps	£1385.00
OKI	82A 120cps	£255.00
OKI	84A 200cps	£630.00
OKI	OKI 92P 160cps	£379.00
OKI	OKI 2410P 350cps	£1535.00
SEIKOSHA	GP100A	£165.00
SHINWA	CP80 Model II FT	£175.00
STAR	DELTA 10 160cps	£329.00
STAR	DELTA 15 160cps	£445.00
STAR	GEMINI 10X 120cps	£199.00
STAR	GEMINI 15X 120cps	£295.00
STAR	RADIX 10 200cps (NLQ)	£449.00
STAR	RADIX 15 200cps (NLQ)	£549.00
TEC	1550 120cps	£465.00
TOSHIBA	TH2100H 192cps	£1275.00
TREND	930 200cps NLQ 80cps	£1350.00

MAYFAIR MICROS

BLENNHEIM HOUSE, PODMORE ROAD,
LONDON SW18 1AJ

TEL: 01-870 3255

We accept official orders from UK Government and Educational Establishments. Mail Order and Export Enquiries welcome. Callers by appointment.

** DAISYWHEEL ** ** PRINTERS **

		EX VAT
BROTHER	HR1	£445.00
BROTHER	HR15	£329.00
BROTHER	HR15 Keyboard	£135.00
BROTHER	HR15 Sheet Feeder	£185.00
BROTHER	HR15 Tractor Feed	£62.00
BROTHER	HR25	£549.00
CANON	AP400 KSR	£760.00
DAISYSTEP	2000 20cps	£240.00
DIABLO	630 API	£1315.00
DIABLO	Sheet Feeder	£490.00
FUJITSU	SP830 RO(S) 80cps	£1195.00
JUKI	6100 18cps	£325.00
NEC	2010 Serial 20cps	£645.00
NEC	2030 Parallel 20cps	£645.00
NEC	3510 Serial 35cps	£1149.00
NEC	3530 Parallel 35cps	£1149.00
NEC	7710 Serial 55cps	£1499.00
NEC	7730 Parallel 55cps	£1499.00
OLYMPIA	ESW103	£825.00
QUME	11/40 RO	£1185.00
QUME	11/55 RO	£1370.00
QUME	9/45 RO	£1550.00
QUME	9/55 RO	£1900.00
RICOH	RP1300S	£895.00
RICOH	RP1600S	£1190.00
RICOH	RP1600S FLOWWRITER 8k	£1249.00
RICOH	RP1600S FLOWWRITER 8k	£1249.00
IBM PC		£1299.00
RICOH	RP1600S Sheet Feeder	£459.00
RICOH	RP1600S Tractor	£138.00
SILVER REED	EXP550(P) 16cps	£570.00
SMITH		
CORONA	TP1 12cps	£195.00
TEC	STARWRITER F1040 40cps	£895.00
TEC	STARWRITER F1055 55cps	£1235.00
TEC	Sheetfeeder	£459.00
TEC	Tractor	£138.00
UCHIDA	DWX-305(S or P) 18cps	£230.00

** PLOTTERS **

MANNESMANN	PIXY PLOTTER	£495.00
GOULD	PLOTTER	POA

BBC MICRO REPAIRS by MICROFIX

ACORN AUTHORISED SERVICE CENTRE

**"Cumana Disc Drive and Acorn DFS
supplied and fitted at low prices"**

We will repair your faulty BBC micro, disc drive or monitor quickly and at a reasonable charge. Most repairs cost between £10 and £20.

We can also offer extended warranties on all your equipment.
Send S.A.E. for full price list.

Phone 01-968 9214
or call in at

191 Freston Road,
(Latimer Road Tube)
London W10

and ask for
Mark Duffill or Derek Mullings.

Canon PW-1080A Wire Dot Printer

A Printer with Flexibility and
Real Impact ...

Twillstar Computers Offer £289 INCLUSIVE!



*Price includes free
printer cable



... If you are looking for high-speed, high quality printing in one compact unit, then this Canon PW-1080A unit is for you. Couple that with the special fully inclusive Twillstar offer price of £289, and you have a really exceptional bargain!

The features include:

- *High speed printing: 160 characters per second
- *Bi-directional, logical seeking
- *Quiet operation: less than 60dB
- *High-resolution graphic printing: N x 16 dot matrix
- *Down loading for user-optional characters
- *4 character styles printable on the same line
- *Superscript and subscript available
- *International character sets selectable
- *Selectable line feeding: 1/8" and programmable
- *Handles; roll paper, fanfold, single sheet and multipart copy paper

HOW TO ORDER

To purchase the Canon PW-1080A printer, simply write your name and address on a piece of paper, and post to the address below, enclosing your cheque/P.O. made payable to Twillstar Computers Ltd.
If you are a Credit Card Holder, simply use the telephone to place your order.

TCL

Twillstar Computers Limited

17 REGINA ROAD, SOUTHALL, MIDDLESEX UB2 5PL. TEL: (01) 574 5271



1st

IN BROMLEY

BROMLEYS FIRST
SPECIALIST COMPUTER STORE

We are official Acorn Dealers with high standards to maintain and take pride in friendly and efficient advice and service.

See our extensive range of printers, monitors, disc drives, software and books.

Data Store

6 Chatterton Road, Bromley, Kent. 460 8991

MAD ALEX GETS AMICABLE

Simon Dally
delivers another
problem cooked up
by the demented
dungeon-dweller.

Can you find the
combination to
Kitty's Kitchen
by juggling
amicable numbers?

88

THIS month you find yourself back in the *Acorn User* dungeon. As you trace your path beneath the sewers of Long Acre, brushing aside the debris of centuries of Covent Garden vegetables and failed competition entries, you notice a sign with an arrow pointing upwards and a placard proclaiming The Freemason's Arms, 'Verily there be magicke afoot here,' you tell yourself as you thrust aside the manhole cover. And God's teeth, who should confront you, stuffing himself with bangers and chips (especially the latter), with beans only 30p extra, but your old adversary Mad Alex!

Having ordered your wild boar's head with potter sauce and ward stuffing you satisfy yourself that for once in his miserable life Mad Alex is in dwarf mode!

Newcomers to the dungeon may need reminding that dwarves invariably tell the truth at all times and trolls always lie. Now, Alex explains to you as he quaffs another hogshead of Bull's Blood, he will introduce you to another breed in the dungeon - the gremlins!

A gremlin, you learn, is somewhere between a dwarf and a troll - but you never know quite where you are with them. Sometimes they lie. Sometimes they tell the truth. 'Filthy brutes,' growls Mad Alex, scooping up his beans with a piece of veroboard, 'just like certain computer manufacturers I know ...'

With his soldering iron, Mad Alex burns into the solid walnut veneer of the table the problem you have to solve before he will escort you further. Actually, he ripped it off from *Acorn User* reader Trev Buck, but he doesn't like to admit it. It goes as follows:

'A pair of amicable numbers are those where the factors of the first number (apart from the number itself) sum to give the second number; and the factors of the second number (apart from the number itself) sum to give the first number. However, a number cannot be 'self-amicable' - eg, 6 is self-amicable as $1 + 2 + 3 = 6$. The first pair of amicable numbers is 220 and 284. The problem is to find the next four pairs.'

Mad Alex scratches his gold earring and says, 'Trev has written a program in BBC Basic which finds them in 1 hour

13 minutes and 10 secs. I'm trying to do better'.

For our purposes the numbers will be referred to as Amicable 1 (220, 284) Amicable 2 (the next pair), etc.

Mad Alex explains that in each of the corners of the room he is about to show you there is a dwarf, a troll and a gremlin. There is one exception: in corner 3 he has had to zap a recalcitrant troll who was trying to steal his makeup - so there is only a dwarf and a gremlin there. In each case you must identify who the gremlin is and follow only his instructions. If you do the puzzle correctly you will end up with the number of the combination lock to Kitty's Kitchen, where untold culinary (and other) delights await you.

You start off with the number 10,000 as your combination.

Corner 1

A: I am a gremlin. Add the numbers of Amicable 2 to your combination.

B: A speaks the truth. Subtract the lower number of Amicable 2 from your combination.

C: I am a gremlin. Add the higher figure of Amicable 2 to your answer.

Corner 2

A: I am a gremlin. Add the higher figure of Amicable 3 to your answer.

B: A speaks true. Add the lower figure of Amicable 3 to your answer.

C: I am not a gremlin. Add the difference between the two Amicable 3 figures to your combination.

Corner 3

A: Add both Amicable 4 numbers to your combination.

B: Subtract the lower Amicable 4 number from your answer.

You ask A whether B is a gremlin. From his (Yes/No) answer you can deduce instantly which is the gremlin and which is the dwarf.

Corner 4

This is the most difficult corner of all. The three characters speak in a tongue called Acornspeak (unknown to you), and Alex (who is a bit of a tease) has to translate for you. First they speak in English.

A: Multiply your answer by the lower figure of Amicable 5.

B: Add the higher figure of Amicable 5 to your number.

C: Subtract the higher figure of Amicable 5 from your number.

Each then makes a declaration that Mad Alex 'interprets' for you.

He says that A announces either that C is a troll or that C is a gremlin, but he (Alex) won't tell you which. Then he tells you that B says A is either a dwarf, a troll or a gremlin but again he (Alex) won't tell you. Finally C speaks up and Alex says C has declared which category B falls into but again he (Alex) won't tell you which of the three it is. But being a perfectly logical being, bitwise, he (Alex) has already fathomed out which is which!

With the greatest restraint, and mindful of your desire to get into Kitty's Kitchen, you point out that while he may know which is which, you don't have enough information to go on. Alex then relents and tells you exactly what A said - and now you find you know what type each character is without a shadow of doubt.

What is the combination to Kitty's Kitchen?

THIS MONTH'S PRIZES

(worth more than £580!)

THREE CUMANA

100k

DISC DRIVES
TO BE WON

(40-track, single sided)

The first three correct entries to be
pulled out of the hat will be the winners

Answers on a postcard please to arrive not later than October 5, 1984 to:

September Competition, Acorn User, Redwood Publishing, 68 Long Acre, London WC2E 9JH



BBC/ELECTRON PROFESSIONAL SOFTWARE

Our educational software is used in thousands of schools and homes throughout Great Britain.

EDUCATIONAL 1

BBC/ELECTRON

Tape £8.00 Disc £10.00

Hours of fun and learning for children aged five to nine years. Animated graphics will encourage children to enjoy counting, maths, spelling and telling the time. The tape includes six programs: MATH 1, MATH 2, CUBECOUNT, SHAPES, SPELL and CLOCK.
... 'An excellent mixture of games' ... Personal Software - Autumn 1983.

EDUCATIONAL 2

BBC/ELECTRON

Tape £8.00 Disc £10.00

Although similar to Educational 1 this tape is more advanced and aimed at seven to twelve year olds. The tape includes MATH 1, MATH 2, AREA, MEMORY, CUBECOUNT and SPELL.

FUN WITH NUMBERS

BBC/ELECTRON

Tape £8.00 Disc £10.00

These programs will teach and test basic counting, addition and subtraction skills for four to seven year olds. The tape includes COUNTING, ADDING, SUBTRACTION and an arcade type game called ROCKET MATHS which will exercise addition and subtraction. With sound and visual effects.

FUN WITH WORDS

BBC/ELECTRON

Tape £8.00 Disc £10.00

Start your fun with alphabet puzzle, continue your play with VOWELS, learn the difference between THERE and THEIR, have games with SUFFIXES and reward yourself with a game of HANGMAN.
... 'Very good indeed' ... A&B Computing - Jan/Feb 1984

JIGSAW AND

SLIDING PUZZLES

BBC/ELECTRON

Tape £7.95 Disc £9.95

There are two jigsaw and four sliding puzzles on a 3 x 3 and 4 x 4 grid. Each program starts off at an easy level to ensure initial success but gradually becomes harder. It helps children to develop spatial imagination and in solving problems. The tape includes: OBLONG, JIGSAW, HOUSE, NUMBERS, CLOWN and LETTERS.

KON-TIKI

BBC

Tape £12.95 Disc £14.95

Simulation program based on Thor Heyerdahl's KON-TIKI expedition. Enjoy a journey on the KON-TIKI recording on a map the raft's position and entering notes in the logbook on creatures found, unusual events etc. Inclusive of booklet, background information, maps and fully supportive illustrated data sheets.

★★SPECIAL OFFER★★

Buy three titles and deduct £4.00

Add 50p p&p per order. Please state BBC or ELECTRON or 40 or 80 track for discs.

SEE US AT
The 2nd
Official
Acorn User
Exhibition
OLYMPIA
16-19 AUGUST
1984

Golem Ltd, Dept A, 77 Qualitas, Bracknell, Berks RG12 4QG. Tel: 0344 50720

EXPORT

WE SUPPLY ACORN & TORCH. . . .

SPARE PARTS
PERIPHERALS
EPROMS
DISKS
SPECIALIST SOFTWARE
UPGRADE KITS

TO ANY PART OF THE WORLD

ALL AT COMPETITIVE PRICES.
VAT FREE.
SEND FOR OUR CURRENT PRICE LIST.

THIS MONTH'S OFFER

VERBATIM DISKS.
FREE DISKHEAD CLEANING KIT
WITH EACH BOX OF 10 5 1/4" DISKS.

HOLDERNESS COMPUTERS
17 Westgate, Patrington, near Hull,
North Humberside.
0964 30225.

7 COLOUR PRINTER!

Canon PJ 1080A Colour Ink-Jet Printer

The ultimate in producing print-outs
in 7 VIVID colours!

Twillstar Computers
Offer £399 inclusive of VAT!
Please add £8 p & p.

*Price includes
free cable.

Telephone
Orders
574 5271

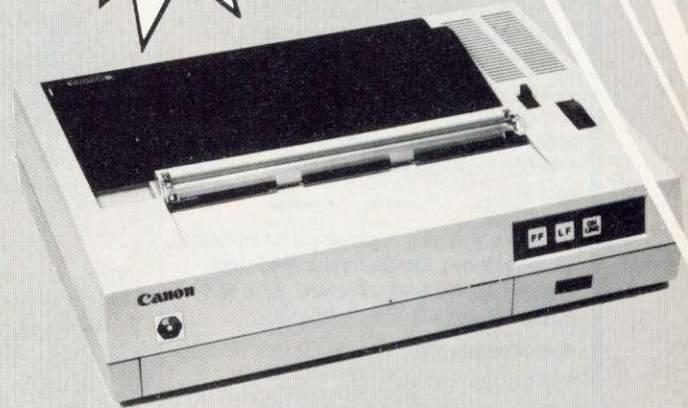

The Canon Ink-Jet Printer has many features, but its main feature is the capping mechanism with completely sealed ink supply operation! Capping prevents the ink from drying out and dust particles from clogging up the nozzles, giving you clear beautiful colour print-outs!

Office or home this is the ultimate in Colour!... at £399 inclusive of VAT it's worth switching right now!

The features include:

- * 7 Colour Drop on Demand ink jets.
- * 37 cps, Bi-directional printing.
- * High-resolution graphics.
- * Extremely quiet, less than 50dB.
- * Will print on acetate sheets, for overhead projection.
- * Long life ink cartridges -
- 3.5 million characters per Colour!
- * Very compact and lightweight.
- * 8-Bit Parallel int-Epson compatible.
- * Easily replaced Colour Cartridges.
- * Accepts single sheets.
- * International character sets.

HOW TO ORDER

To purchase the Canon PJ 1080A printer, simply write your name and address on a piece of paper, and post to the address below, enclosing your cheque/P.O. made payable to Twillstar Computers Ltd.
Credit Cards If you are a Credit Card holder, simply use the telephone to place your order.

TCL

Twillstar Computers Limited

17 REGINA ROAD, MIDDLESEX UB2 5P2. TEL: (01) 574 5271



Where do 100,000 DP Managers obtain their computer supplies? - From Inmac

Better solutions for professionals-faster!

These days, there are dozens of companies offering to supply your computer needs. They come — and they go.

Yet more and more computer professionals are turning to Inmac for all their requirements.

You don't need a computer to work out why. Inmac are themselves truly professional in every aspect of their business. They don't quote silly prices on loss-leaders — and make it up elsewhere. They provide competitive prices and top-quality service across the board.

And everything carried must be quality. Inmac look after your bottom line — help you provide a more cost effective computer service over all.

Inmac carries many products for leading name equipment like Centronics, DEC, Data General, Diablo, Hewlett Packard, IBM, NEC, Qume, Systime and Texas Instruments.

In addition you get:

- * 30 day risk-free trial,
- * 12 months' minimum replacement guarantee on most products.
- * Next day delivery and same day in the London area.



Protect it!

Your computer system is vital — and vulnerable. Inmac supply a whole range of safety and security devices from special fire extinguishers to clever security locks.

Ring for our catalogue containing over 1,000 great ideas.

09285 67551 or 01740 9540

INMAC (UK) LIMITED
Dept 818, Davy Road,
Astmoor,

Runcorn, Cheshire,
WA7 1PZ United Kingdom.
Telex: 629819

INMAC (UK) LIMITED
Dept 818, 16 Silver Road,
London W12 7SG
United Kingdom.
Telex: 924313

PRODUCT OF THE MONTH

Your 5 star DEC cartridge service

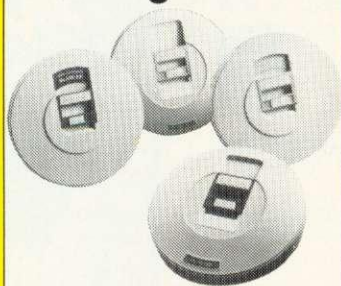

3 YEAR GUARANTEE

30 day risk free trial Free Advisory Service
Next day delivery Original DEC quality

We also supply most other major manufacturers disk cartridges. Just call us to check your requirements.

CABLES AND CONNECTORS

Just tell us what connections you need — we will supply your requirements from stock today. We can also custom build cables to your specification in only 5 days. Inmac prices can save you up to 20% and still give you next day delivery, no minimum order and a 3 year risk-free guarantee.



PRINT PERFECT

Whatever the make, whatever the type of printer or typewriter, Inmac have the right ribbon for your needs. Precision manufactured, with high yield and quality results. Print wheels? Ours are compatible with Diablo, Qume, Olivetti, etc.



'T' SWITCHES

You won't find a larger range than Inmac — we supply everything from a simple two device switch up to the super sophisticated Auto-T-Switch which "speaks" to you and cues you automatically.

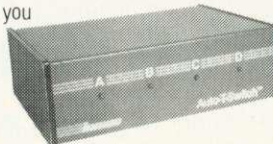

Get a better deal all round

The products described on this page are just a tiny selection from the total Inmac range. If you see what you need here — phone us now and we'll deliver it tomorrow or sooner. Just phone us and talk to our free advisory service — we'll do our best to help meet your needs.

Name _____
 Title _____
 Company _____
 Address _____

 _____ Postcode _____
 Telephone No. _____
 My computer system is _____
INMAC (UK) LIMITED 829



The Twillstar Reliability. It's what makes us The Leading Computer Shop!

* TAKE ADVANTAGE OF OUR 24 HOUR TELEPHONE ORDERING SERVICE *

PRINTERS

FREE INTERFACE CABLE & 500 SHEETS OF PAPER WITH ALL PRINTERS

DOT MATRIX £389

EPSON FX80

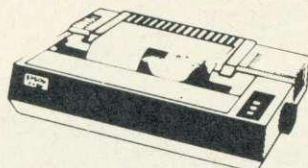

EPSON RX80 F/T	£279.00
EPSON FX100	£499.00
EPSON RX100 F/T	£399.00

SHINWA

SHINWA CP80	£199.00
MANNESMANN TALLY MT80	£230.00
COSMOS 80	£199.00

RITEMAN MATRIX PRINTER

80 Column, friction and pin fee. 120 CPS, Bi-Directional, Hi-Res and block graphics. 9 x 9 matrix true descenders, normal, expanded, condensed printing, emphasised and double strike printing, italics printing, auto underlining, subscript and superscripts, international character sets, easy access dialswitches. 1:1 High-Res (true circles and squares), optional tractor unit, optional RS232C interface. £230.00

CANNON

CANNON PW1080A	£289.00
CANNON PW1156A	£399.00
CANNON PJ1080A	£399.00

COLOUR PRINTER £399.00
Colour Drop on Demand Ink Jet. 40 CPS, Bi-Directional Printing, High-resolution Graphics. Extremely quiet. Less than 50dB. Ideal for Overhead Projection. Long-life Ink Cartridges. 3.5 Million Characters per Colour. Very compact and light weight. 8-Bit Parallel Int - Epson compatible. Easily replaced. Accepts single sheets. International character sets.

DAISYWHEEL PRINTERS

JUKI 6100	£379.00
BROTHER HR15	£395.00

13 CPS. 10, 12, 15 CIP and proportional spacing up to 165 characters per line, colour printing, shadow printing, super/sub script, auto underlining, text reprinting. 3K Buffer Standard.

Keyboard	£160.00
Sheet Feeder	£228.00
Tractor Unit	£109.00
DAISYSTEP	£259.00

MONITORS

ALL MONITORS COME WITH FREE CONNECTING CABLES

NOVEX 14" £215 MONITOR

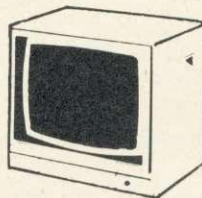

Low-cost model for personal computers. 14" Screen colour display. R.G.B. and composite inputs. Switch to allow monitor to be used as green screen monitor. Switch mode auto-regulated power supply. Professionally-styled Metal-Cabinet in BBC Micro-colours.

PHILLIPS V7001 £75.00

COLOUR MONITORS

MICROVETIC CUB 1431 RGB Standard Res	£199.00
MICROVETIC CUB 1451 RGB Medium Res	£299.00
MICROVETIC CUB 1441 RGB High Res	£399.00

TV/MONITOR - NORDMENDE £249

14" TV/MONITOR
This TV Monitor is not a modified television as many TV Monitors are, but a 14" TV/Monitor which has been designed to perform both functions. It has RGB and Composites video and sound. An RGB cable for a BBC is supplied as standard. With Remote Control.

DISK DRIVES

TEAC DISK DRIVES
INCLUDES FREE CABLES,
FORMATTING DISK &
MANUALS

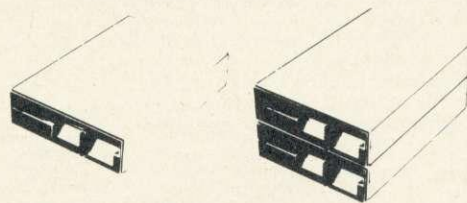

TEAC 55A S/S 40 TRACK	
100K Single	£140.00
200K Dual	£280.00
TEAC 55E S/S 80 TRACK	
200K Single	£190.00
400K Dual	£380.00
TEAC 55F D/S 80 TRACK	
400K Single	£220.00
800K Dual	£440.00
Power Supply Unit (Optional)	£29.00
40/80 Switch	£8.00

MISCELLANEOUS

MICRON EPROM PROGRAMMER FOR BBC MICRO

Will programme: 27128, 2764, 2732, 2532 & 2716 EPROMS. Designed to be semi-intelligent and uses THE HIGH EFFICIENCY ALGORITHM for programming 2764 & 27128's. Whereas other machines can take 16 MINS to program a 27128 16K eprom, the MICRON PROGRAMMER (typically) takes 3 MINS.

Why waste time when you could program five 27128's in the same time as others take to program one! Fully menu driven.

BBC MICROCOMPUTER

Model B	£399.00
Model B & Disk Interface	£469.00
Model B & Econet	£446.00
Model B & Econet & Disc Interface	£516.00
Teletext Receiver	£225.00
Teletext	£225.00
6502	£199.00

TURN YOUR BBC TO A BUSINESS MICRO!

USE A Z80! £299.50
Connect up a Z80™ and your BBC Microcomputer becomes a complete business micro, with all the computing power a professional needs. The Z80 unit contains a second microprocessor which will work alongside the BBC Microcomputer's own processor. Together, they make a formidable team!

To put your new computer into action, the Z80 pack includes a set of programs that cover all the major business applications, and that make the most of the system's impressive capabilities. With Z80 systems, big businesses can distribute work stations among all their decision makers. And small businesses can afford the computing power that will help them grow bigger.

UPGRADES FOR BBC MICRO

1.20/S	£11.50
Basic II	£32.00
Disk Interface Kit	£97.00

AND MORE ...

ECONET ACCESSORIES

Econet Interface	£70.00
Clock Box (Inc. PSU)	£45.00
Terminator Box (Inc. PSU)	£35.00
Printer Server rom	£49.00
File Server Level 1 (in stock now)	£99.00
File Server Level 2 (in stock now)	£249.00

THE ACORN BITSTICK GRAPHICS SYSTEM

£375.00
Installed on the BBC Microcomputer, whether for general use in business and education or dedicated to technical graphics, this system provides facilities previously available only with the most expensive COMPUTER-AIDED DESIGN Systems on the market.

JUST A FEW OF THE FEATURES

Create a design - modify it anytime. Draw straight lines, arcs, circles ... colour fill, erase, reposition again and again, then add text ... All without touching a pencil!

Store the Drawing.

When the drawing is complete save it just as if in a filing cabinet. Retrieve it for use anytime - next day, next year ... The drawing remains available until erased. Make prints as you need them. When hard copy is required, permanently record your creations with a printer.



**Twillstar
Computers
Limited**

open 6
days a week
10am - 8pm



17 REGINA ROAD · SOUTHALL · MIDDLESEX
TEL: (01) 574 5271 · TELEX NO. 25247 TIL



HOW TO ORDER

You may purchase any of the items listed by cheque made payable to: Twillstar Computers Ltd. Barclaycard or Access. All you have to do is fill in your requirements on a separate sheet of paper, post to us and we will despatch within 24 hours, subject to availability. All prices inclusive of 15% VAT. ADD £2.50 P&P for orders below £150. Over add £8 P&P. Credit Card holders may order by telephone. Give card number, name, address and items required. Please note VAT is not charged on export orders. Export customers please ring for details of P&P.

SOLIDISK SIDEWAYS RAM: 8,000 UNITS SOLD

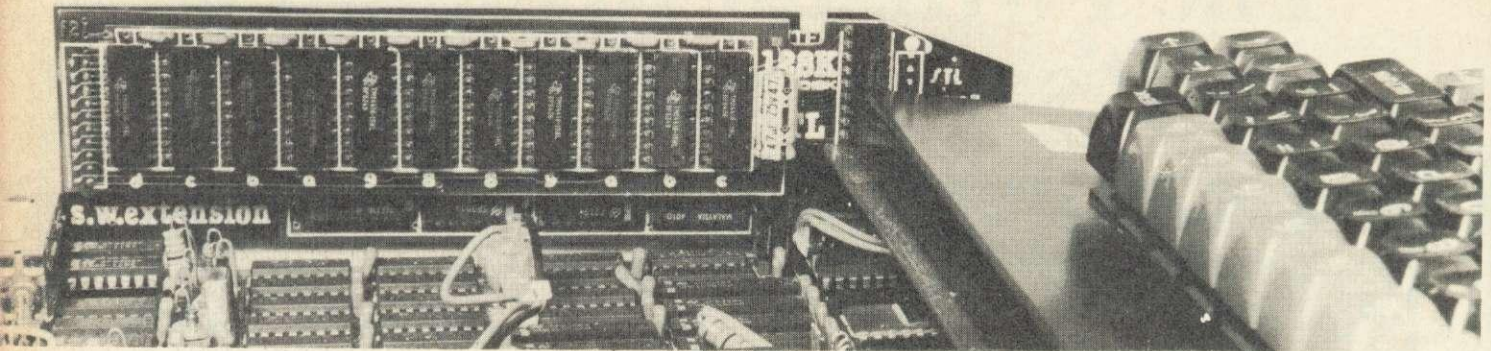

"Exciting" (ACORN USER JAN 84), "Power to your Beeb" (PCN 61, MAY 84)

HOW ABOUT COMPATIBILITY?

The Sideways RAM is completely compatible with all issues of BBC computers, disks, all sideways ROMs, second processor, Torch disk pack, Teletext, Econet etc. but NOT with ROM extension boards, since it can replace them.

Its power consumption is so low that you can use it in conjunction with twin disks.

HOW DOES IT WORK?

Occupying the same place as sideways ROMs (such as BASIC, DFS, CPN etc), it is treated like other Sideways ROMs and therefore can replace them.

The Machine Operating System uses Sideways RAMs as naturally as Basic, without procedures or programming rules.

Sideways RAM can run any language, any filing system including Hi-Basic and second processor DFS.

SIDEWAYS RAM POWER IS IN THE SOFTWARE:

Different from Sideways ROMs, Sideways RAM can be written into. This property gives birth to a NEW GENERATION of software for the BBC computer: SERVICE RAMs and VIRTUAL MEMORY PROCESSOR.

Each SERVICE RAM has its own commands and code as its counterpart Sideways ROM but has its own private workspace and storage area thus leaving you with the lowest possible PAGE value (PAGE = &E00). On the other hand, the Virtual Memory Processor can run huge MACRO BASIC programs (Megabytes are not the limit), keep them on disk and uses the basic 32k of RAM as transient program area. All software for the Sideways RAM system is free.

FREE SOFTWARE?

Solidisk Sideways RAMs is bundled with lots and lots of software, FREE and we mean FREE, now and later. It is quite simple: for every Sideways RAM sold, £1 is spent on MORE software. Sideways RAM users are invited to spot new applications and contributions are rewarded at the usual rate of £1 for every 4 bytes of machine code.

The result is printed on the opposite page.

HOW ABOUT THE FUTURE?

Solidisk Sideways RAM is also widely used in schools for ECONET stations, by professional programmers for writing programs, research laboratories for RAM disk data base, at home for wordprocessing and now even games.

New areas are being developed: Telesoft and Teletext logging, Speech Processor assembler and Relational Data base to cite a few.

As the price of 16k EPROMs are as high as £20 at the present time, more Sideways ROM software publishers will be willing to sell their software on disk. Solidisk will mail FREE OF ANY COST their advertisement to ALL Sideways RAM users providing the price of the Disk version reflects savings in the cost of the ROMs. Solidisk believes that the majority of BBC users will have their Sideways RAM fitted before the end of next year.

Also unlike other makes (SIR, APTL, WE Sideways ROM/RAM extension boards and the Aries B20), Solidisk Sideways RAM is expandable from 16k right to 128k and now to 208K. As a result of VLSI technology and volume of sales, Solidisk products also have a lower shop price than any other products.

OTHER PRODUCTS FROM SOLIDISK:

UVIPAC EPROM ERASER:

Uvipac is powered by the mains, simple to operate and can erase 3 Eproms of any type in just 15 minutes. Uvipac is ideal for home use.

DETACHABLE KEYBOARD CASE:

Remove the keyboard from the BBC computer and instal it in the new case. Replace the old 3" keyboard tail by the new 24" cable and you can work really in comfort even for very long hours. The keyboard case is more a productivity tool than just ergonomics.

CPU CASE:

Replace the top of the BBC computer case by this metal CPU case. Sit your monitor on top (it is tough enough to take even your weight!). The CPU case has 2 compartments for half height 5.25" disk drives with fixing screws, air vents and provision for a bolt-on fan. At first sight, there is no trailing wire. Looking inside, there is enough room to accomodate Teletext Adapter, Second Processor, Solidisk and a fan!

DOUBLE DENSITY DISK INTERFACE:

2 versions of this double density interface will be available: as direct replacement for the Acorn Disk Interface (Version A) and as a Second Disk Interface (Version B) adding to your existing interface. They all use the same Western Digital controller chip (WD1770). Price £39.95 inclusive

DISK DRIVES:

3 models are being offered:

STL55A: 40 tracks single sided, SLT55F: 2 x 80 tracks, double sided and the best of mini floppy technology STL320: 2 x 160 tracks, double sided.

All disk drives are supplied with cables, formatter disk, head cleaning kit and 2 year warranty.

"Break the Ram Barrier" (A&B)

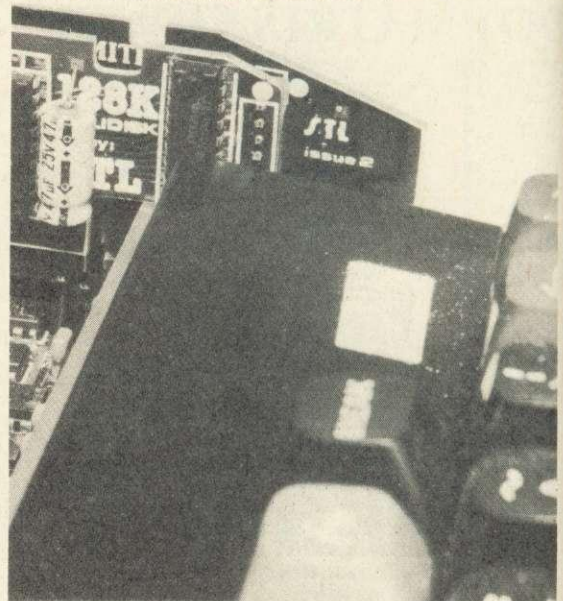

UVIPAC EPROM ERASER

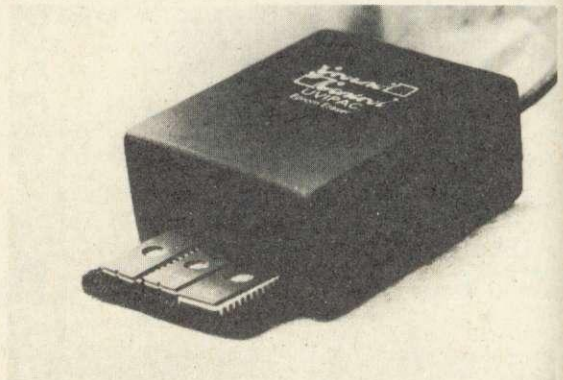

TEAC DISC DRIVES FD55 Series

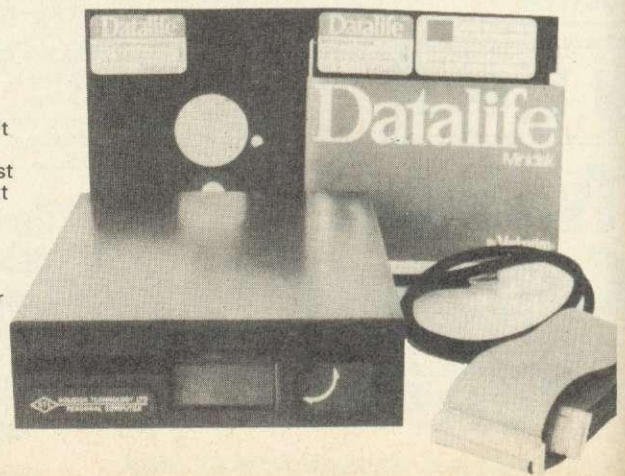

WHICH SIDEWAYS RAM DO YOU NEED?

Solidisk Sideways RAM is available in 16 (SWR16), equivalent to 1 sideways ROM, 32k (SWR32), equivalent to 2 sideways ROMs, 128k (Solidisk), equivalent to 8 sideways ROMs and the 208k Solidisk equivalent to 12 Sideways ROMs. You can buy a small Sideways RAM now and upgrade it later. From the SWR16 to the SWR32 is by straight exchange, from the SWR32 to the Solidisk is by adding the 96k Solidisk Extension, from 128k to 208k is by exchange of the RAM card.

FREE SOLIDISK SOFTWARE:

WORD64:

WORD 64 is a Service RAM, it uses Solidisk as storage for WORDWISE, up to 64K free characters for any text.

SILEXICON:

SILEXICON is a Spelling Checker for Solidisk. SILEX scans texts at more than a 1,000 words a minute and compares each word against the dictionary, Silexicon marks the mis-spelt words for either addition to the dictionary or eventual correction.

PRINTER BUFFER:

PRINTER BUFFER is a Service RAM, it increases 500 times the normal 32 bytes printer queue to 15K bytes, completely transparent to the user. PRINTER BUFFER is as useful for printing a long document as for a short program listing.

STLEO:

STLEO is a Service RAM, it is Disk Filing System that leaves PAGE at &E00, has built-in disk formatter/verifier and automatic track stepping for 40/80 track disk drives.

STL150:

STL150 is a Service RAM to enhance Acorn's .90 DFS to offer up to 150 directory entries per side.

STL-RFS:

STL-RFS (RAM/ROM filing system) is a Service RAM and an innovation in portable applications. STL RFS saves any program in a Sideways ROM format, it can then be copied onto EPROM to give instant recall of your programs. Plug this EPROM into any sideways socket, type *RFS and it runs itself. Compatible with the ELECTRON and BBC, tape and disks, SWR16, SWR32 and Solidisk.

INDEX:

INDEX is a Service RAM, it stores all the entry points of one or several sequential data files such as mailing list, stock list, accounts etc, merges, sorts them in alphabetical order and gives instant access to any record. INDEX can handle 1,100 records of any size, any type, any number of fields.

MACRO-BASIC:

MACRO-BASIC is a program generator. You use a wordprocessor to create a command file which is then scanned by MACRO. MACRO uses other programs, subroutine libraries, text files (actually any or all files on your disks) as source to generate a bug free BASIC program which can be very large (Megabytes are not the limit).

VIRTUAL MEMORY PROCESSOR:

VIRTUAL MEMORY PROCESSOR (VMP) uses extensively overlay technique and Solidisk as back store for very large programs that cannot be run otherwise. VMP uses the 32k basic RAM as transient area: it operates on a Main Program as generated by MACRO-BASIC, taking different segments from the Solidisk Store, POOL, HOLD, FREE or CLEAR segments from the transient area. For example: VMP will accept 20 segments of 10k of Basic assembler and assembles it into 16k of machine code.

MENU:

MENU puts all computer's resources at your fingertips. MENU displays your Sideways Firmare, Disk Directories, Sideways RAM system, Solidisk System etc.

MORE FREE SIDEWAYS RAM SOFTWARE TO COME:

While others are making promises for software to be written, Solidisk Systems RAM comes with a complete, novel and powerful software package including compatibility with existing sideways software.

Each Sideways RAM is accompanied by the Sideways RAM User Manual, full 1 year warranty, 1 utility disc* and free mailing on all new publications from the Software Support Service.

*It should be understood that we cannot put as much free software on a 40 track single sided as on 80 tracks. The present software package require 160 tracks of storage and can be accommodated on ONE 2 X 80 track double sided diskette, only the most useful programs are supplied on other formats (ie 40 track single sided, 2 X 40 track double sided, 80 track single sided). Should you require the whole collection of free software, please place an order for extra disks. For the technical minded: the Source Code and Technical Manual (3 floppies and a 300+ page book) price = £10, the SILEXICON EXTENSION PACKAGE (3 floppies and a 40 page manual, 30,000 word dictionary: English and French now, German and Spanish planned) price = £9.00. '45' also publishes regular updated SWR utility discs at £3.00. Every user can do contract work for the SUPPORT SERVICE and make a lot of money for him/herself!

HOW TO ORDER?

You can order any item using the coupon. Post and packing is only charged once. Access and Barclay card holders can place their order by phone. Educational authorities, Acorn dealers and OEMs can obtain quantity discounts.

Name:

Address:

Credit Card Account:

Callers are requested to ring first for appointment.

Total: £

If ordering more than one item, deduct £1 per item as post and packing cost is only charged once.

SOLIDISK TECHNOLOGY LIMITED
17 SWEYNE AVE
SOUTHEND-ON-SEA
ESSEX SS2 6JQ

SOLIDISK'S NEW TELEPHONE NUMBER:
SOUTHEND-ON-SEA (0702) 354674
(10 lines with automatic exchange)

HOW EASY TO INSTALL:



Push in the base unit

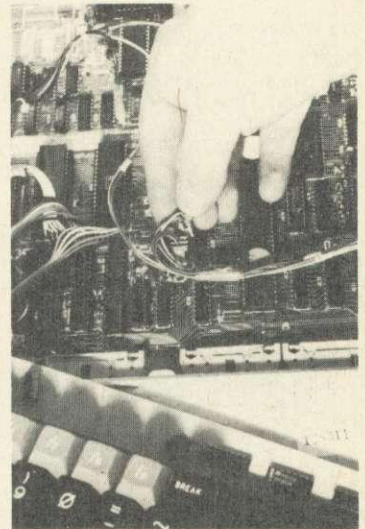

Connect the control wires

SEE US AT

The 2nd
Official
Acorn User
Exhibition

OLYMPIA
16-19 AUGUST
1984

PRICE LIST (including VAT and post & packing)

SIDEWAYS RAM:	
SWR 16K	£43.65
SWR 32K	£59.95
128K SOLIDISK	£150.95
208K SOLIDISK	£243.00

The following are upgrade prices for existing Sideways Ram owners:	
16 - 32 (please return complete item)	£18.00
16 - SOLIDISK (please return complete item)	£109.00
32 - SOLIDISK (no return necessary)	£93.00
128K - 208K SOLIDISK	£93.00

DISK DRIVES:

STL55A (40 track, single sided, cased with cables, diskette, manual and 2 years warranty)	£142.95
STL55F (2 X 80 track, double sided, as above)	£232.95
STL320 (2 X 160 tracks, double sided, as above)	£499.00

FLOPPY DISKS (DATALIFE Verbatim):

MD525 (SS/DD 40 or 80 track) box of 10	£16.00
MD550 (DS/DD 40 or 80 track) box of 10	£22.00
MD557 (DS/DD 98 TPI) box of 10	£27.00

CPU CASE

£13.00

DETACHABLE KEYBOARD CASE

£27.99

EPROM PROGRAMMER (used with Sideways Ram)

£16.00

UVIPAC EPROM ERASER (free standing unit)

£20.95

2764 PACK OF 5

£36.00

SOURCE CODE + TECHNICAL MANUAL

£10.00

SILEXICON EXTENSION PACKAGE

£9.00

WE STOCK A LARGE RANGE OF PRINTERS AND MONITORS. CALL OUR SALES OFFICE FOR IMMEDIATE QUOTATION.

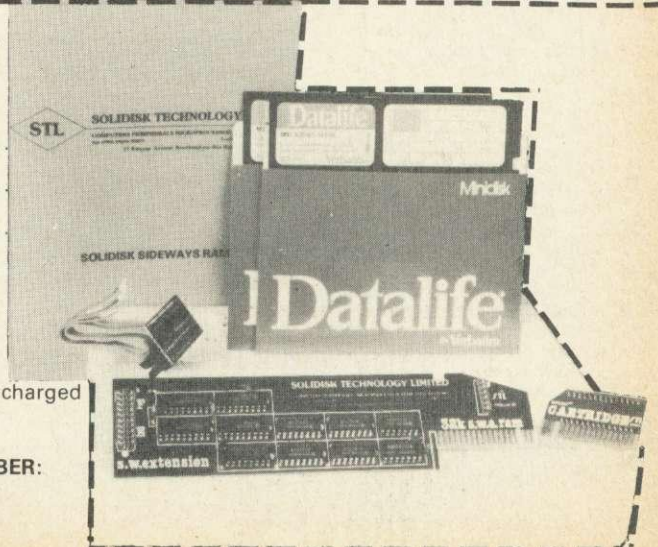

BACK ISSUES £1.25

6. January 1983 MEP school launch. *FX commands for sound. Second BBC TV series. Machine code 3—two pass assembly. Disc drives for the Beeb. Programming forum. Program protection. Micros in schools—new series. Commodore Pet printer used with Beeb. BBC programs written on an Atom. Extra Atom memory.

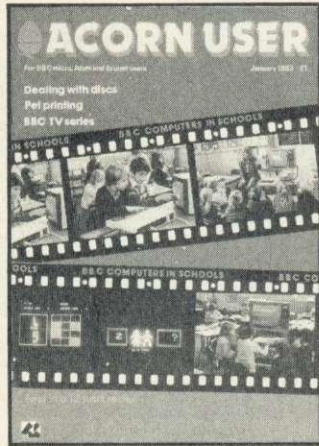

7. February 1 MHz bus examined. 3D Atom graphics. Atom BBC Board reviewed. Machine code 4—memory. BBC Computer Literacy update. Atom error handling. Micros in schools 2—getting organised. Hints and Tips. Beeb Forum. Reviews of *Wordwise* and the Amber printer. ***

8. March Chess on the BBC micro. Sound on the Beeb. Printers for beginners. Atom analogue converter. Schools 3—micros and maths. Machine code 5—indirect addressing. DIY lightpen. MEP's *Microprimer* review. Atom Ross toolkit review. Beeb Forum. Assembly language and Pascal book reviews. ***

9. April *Hexangle* game listing. Bach on the Beeb. Hints & Tips on disc drives. Machine code 6—the CALL statement. Interfacing the 1 MHz bus. Schools 4—young children and micros. Graphics listings. Printers for beginners 2. Reviews for BCPL, educational software and Atom software. ***

10. May Review of Basic II. Graphics listings. New *FX calls in OS1.2. Colour mixing on the Beeb. Jazz, blues and folk on the BBC. Schools 5—language development. DIY Beeb interface box. Atom sound board. A to Z of printing: how to get going. Hints and Tips: PROCs, discs and FNs. Printer, software and book reviews.

11. June Techniques series—sorting. Hints and Tips: 50p network. Drawing techniques and CAD. Machine code: interrupts. Schools 6—information technology. Atom Forum. Beeb Forum. Printers—write your own graphics dumps. Comparative review of *View* and *Wordwise*. Three graphics packages reviewed. Test of *Acorn User's* interface box.

12. July Techniques—hash tables. Hints and Tips: logic made easy. Recursion and graphics. Handling strings. Two ideas for passing variables. Beeb aids the blind. DIY second keyboard. Beeb Forum. Sounds on the Atom. Hardware, firmware, software and book reviews. Atom Forum.

13. August Printer graphics and dumps. Techniques—Tree structures and sorting. All the fun of the fair. 40/80 disc copier. Colour painting. Basic II: random access files. Screen dumps for

Olivetti, Centronics and Seikosha. Atom strings. Reviews of Tandy CGP115 printer, five educational packs, A to D converter.

14. September Techniques—ink-blots and mazes. Painting by lightpen. DFS space explored. Beeb Forum. *Mega Monsters* game listing. Machine code graphics dumps. Atom Forum. Atom cassette recorder check. Reviews of Atom RAM boards, Cumana disc manual, *Logo* for schools, Hobbit floppy tape and books.

15. October Women and computing. Techniques—random numbers. Review of Computer Concepts' *Beebcalc*. Fractal graphics. 57 files on 40 & 80 track discs. *Vampire* game listing. Beeb Forum. Assembly code controls tab key. Osfite merging. Atom future. Atom verify routine. Reviews of *Vu-Type*, Procyon Atom book, Epson FX80, Teletext adapter, disc drive, software.

16. November Techniques—impossible problems. Contour graphics. Connecting two Beebs together. XREF: sorts & lists variable, function and procedure names. Assembler utilities in Basic II. OS. VDU. *FX, OSBYTE calls—pull-out poster. Disc overlays. Adding extra Atom commands. Reviews of 7 educational packs, Atom ROM, books, games.

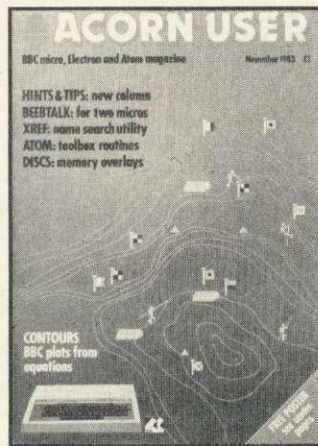

17. December Random graphics. Animated graphics in colour. Techniques—graphs. Hints & Tips. Universal printer dump. 6522 connected to the Electron. Saving machine code. Beeb Forum. Graphics pull-out poster. Index: July 82—July 83. Forum Extra: EQUUS. BBC helps the disabled. Schools—data processing. Transferring data between Beebs, Atoms . . . or



Pets. Atom block demolition utility. Atom disassembler program. Reviews of software, books, educational programs from Chalksoft.

18. January 1984: Games special issue Techniques—graphs part 2. Stacks and queues, Basic and languages. Hints & Tips. Voice chip revealed. How to write games. Electron interfacing. Beeb Forum. Life graphics routines. *Defencecom* game listing. *The Train* Game listing. Machine code graphics. Where to put machine code. Schools—handling data. Juki daisywheel printer examined. Atom Forum and adventure. Reviews of utilities, software, *Beeline* wordprocessor, educational packages, two chess programs.



19. February: Adventures special issue Techniques—efficient sorts. PROC for a numeric keypad on the Beeb keyboard. 12 graphics listings. Random access filing on disc. Locking files. MCP40 printer/plotter looked at. Hints & Tips. Beeb Forum. Make discs readable on 40 and 80 track drives. Screen memory organisation. Hints on adventure design. Adventure action. Adventure ideas in computer language. Text compression. Word-crunching. VIA chip on Electron to drive a parallel printer. Atom Forum. Schools—simulation packages. Reviews: *Disc Doctor*, Leasalink's DFS upgrade, Hitachi's microdrive system, Solidisk's sideway RAM board, software.

20. March Utility: timing routine. Fractals. Teletext and mode 7 dump. ROMs reviewed. Hints & Tips. Beeb Forum. Add sounds to your games. Learn Lisp 1. Cube graphics. Printer driver for View. Basic II from Basic I. Beeb's ADC chip. Atom Forum. Listing formatter for

the Atom. Atom 'bytes free' routine. Schools—test of *Factfile*. Keyboard skills. Amcom DFS v Acorn DFS. Reviews: *Beebpen* wordprocessor, Atom expansion system, software, books.

21. April Beeb graphics on TV. 6845 chip explored. Advanced filing systems. Lisp 2. Hints & Tips. Beeb Forum. Choose disc tracks to copy. Function key editing. Teletext dumps. CES scrutinised. Passing variables. Computer Concepts' graphics ROM. Schools—simulations. Calculating Easter dates. Better programming. Atom Forum. Atom ROM routines. Converting BBC to Atom Basic. Three printers compared. Reviews: software, Aries B20 RAM board, *Toolkit*, Monitors.

22. May Bitstik graphics system. Hints & Tips. 6502 second processor examined. Lisp 3. Beeb Forum. Disc utility to keep track of available space. Statistics. Pattern graphics. OSWORD explained. 4 colour graphics listings. Second-hand disc drives. Education—do girls get a fair deal? Atom Forum. BBC to Atom Basic 2. Reviews: British Micro's Grafpad, *Edword* wordprocessor, 4 sprite generators, Opus micro-drive, *Beasty*, software.

23. June Acorn Z80 second processor. Forth. Graphics to brighten up your games. Soft Pottery graphics. Go faster and save memory space. Rapid search and load routine for tapes. How the Beeb and Electron work 1. Business: reviews and how to gently enter office computerisation. Education—adult literacy. Dumping Atom programs on the BBC. Atom Forum. Software copyright laws. Hints & Tips. Techniques—B-Trees. Beeb Forum. Reviews of monitors, printers, books, software, adventures, EPROM programmer.



***** Sold-out copies**

Four issues of *Acorn User* are not available—July 1982, February, March and April 1983. Copies of articles are available at 18p a page (minimum charge 50p, inclusive of postage). Orders should be addressed to Kate Evans, Redwood Publishing, 68 Long Acre, London WC2E 9JH.

How to order

Fill in the order form opposite and send with your cheque or postal order (made payable to Redwood Publishing) to Acorn User Services, PHS Mailing Ltd, PO Box 14, Horley, Surrey.

ACORN USER

SUBSCRIPTIONS

Please start my subscription to Acorn User as indicated:



	12 months	24 months
UK	£15 <input type="checkbox"/>	£30 <input type="checkbox"/>
Zone A: Europe	£25 <input type="checkbox"/>	£50 <input type="checkbox"/>
Zone B: Middle East	£30 <input type="checkbox"/>	£60 <input type="checkbox"/>
Zone C: The Americas and Africa	£30 <input type="checkbox"/>	£60 <input type="checkbox"/>
Zone D: All other countries	£35 <input type="checkbox"/>	£70 <input type="checkbox"/>

Name

Address

Please answer these questions to help us improve your magazine.

- Do you use your micro for?:
 school business hobby
 - Do you have, or intend to buy, any of the following?:
 monitor disc drive second processor
 printer modem
 - How many software packages do you think you will buy in the next 12 months?:
 0-5 6 to 10 10 or more
- I enclose my cheque/postal order/sterling bank draft payable to Redwood Publishing for £.....
- Please debit my Access/American Express/Barclaycard
 Account no.
- Signed..... Date.....
- Send this form, with your remittance, in an envelope, to Acorn User Subscriptions, Redwood Publishing, 68 Long Acre, London WC2E 9JH.

EXPRESS ORDER FORM

ACORN USER

SERVICES

SPECIAL OFFERS ON SWEAT SHIRTS

QUANTITY	DESCRIPTION	PRICE
<input type="checkbox"/> RP01	Binders	@ £4.75 £
<input type="checkbox"/> RP02L	Sweat shirts (large)	@ £5.00 £
<input type="checkbox"/> RP02M	Sweat shirts (medium)	@ £5.00 £
<input type="checkbox"/> RP02S	Sweat shirts (small)	@ £5.00 £

BACK DATED ISSUES @ £1.25 per copy

	MONTH	YEAR	
<input type="checkbox"/> AU	<input type="text"/>	<input type="text"/>	issue £
<input type="checkbox"/> AU	<input type="text"/>	<input type="text"/>	issue £
<input type="checkbox"/> AU	<input type="text"/>	<input type="text"/>	issue £
			Total £

Please add £1.00 each for overseas items.
Please allow 28 days for delivery.

Name.....

Address.....

I enclose my cheque/PO payable to Redwood Publishing for £.....

Please debit my Access/Barclaycard
 Account no.

Signed..... Date.....

Send this form, with your remittance, in an envelope, to Acorn User Services, PHS Mailing Ltd, PO Box 14, Horley, Surrey. All the above prices include postage and packing.

EXPRESS ORDER FORM

ACORN USER

SOFTWARE

DISC EXCHANGE SERVICE

Send in your copy of Trek or Sword Master with a cheque for £3.50 and we will exchange it for a disc. (Which runs on 40 or 80 tracks).



..... Tape(s) in exchange for disc @£3.50 each £

Please send me:

	Tape	Disc
..... Copies of Sword Master for BBC (32k series 1.0 OS)	£7.95	£10.95 £
..... for Electron	£7.95	£
..... Copies of Trek for BBC (32k series 1.0 OS)	£7.95	£10.95 £
..... for Electron	£7.95	£

MONTHLY PROGRAM LISTING CASSETTES



Please send me a cassette of all major BBC Micro and Electrons program listings (September issue) as advertised on page 96

@ £3.75 £

Total £

Name.....

Address.....

I enclose my cheque/PO payable to Redwood Publishing for £.....

Please debit my Access/Barclaycard
 Account no.

Signed..... Date.....

Send this form, with your remittance, in an envelope, to Acorn User Software, PHS Mailing Ltd, PO Box 14, Horley, Surrey. All the above prices include postage and packing.

EXPRESS ORDER FORM

24 HOUR PHONE SERVICE (02934) 72208

Please add £1.00 each for overseas items.
Please allow 28 days for delivery.

ACORN USER SOFTWARE

96

FOR THE BBC MICRO AND ELECTRON ON DISC AND CASSETTE

Two quality, full colour games to test your skill, nerve and cunning.
Each £7.95 per cassette or £10.95 per disc (40/80 track).
Price includes VAT and postage.
Both games need OS1.0, or later, and 32k.
Developed, produced and tested by Micrograf.

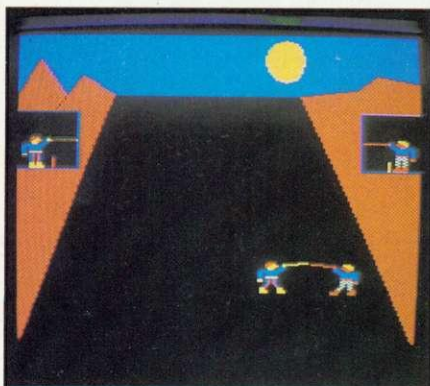

SWORD MASTER is one of the few two-player games around, and is designed for joystick or keyboard.

Sword Master by Ken Worrall is based on the fencing rules written in 1190 by Herman von Salza for the Deutscher Ritter Order of Teutonic Knights. It features full-colour machine code animation of a sword duel between the players shown on screen as knights.

Full instructions, music, sound effects, player rankings (from Greenhorn to Swordmaster) and a roll of honour (which can be saved) are all included. The game also closely reflects the rules, style and dress of the Deutscher Ritter Order.



TREK was the first game to take advantage of voice synthesis on the BBC micro – and uses joystick or keyboard.

Trek puts you in charge of a Starship with the task of wiping out an alien fleet. It's an excellent adaptation of the classic game with 7 screen displays, 3 on-board computers and 2 weapon systems.

Versions have been written for BBC micro and Electron to use both machines to their full. The BBC tape uses voice synthesis (if the chips are fitted).

The game has been extensively developed from Tim Heaton's famous Trek III. It barely fits into 32k.

DISC UPGRADE SERVICE

Return your cassette of Trek or Swordmaster, and we will exchange it for a disc (which will run on 40 or 80-track drives) for just £3.50. Please specify Amcom, Watford or Acorn DFS.

PLUS

ARTICLE LISTINGS ON CASSETTE

Yes, at last, the tape you've been crying out for! Save the wear on your fingers by sending for one of our cassettes giving all the major listings in this issue.

Each cassette costs £3.75 (inclusive) for the Electron and BBC micro. This includes a menu and disc transfer routine to help you find your way around – and use on your own programs.

The tapes come with BBC programs on one side and Electron programs as the other, so it shouldn't be possible to mix the two.
Order form on page 95.

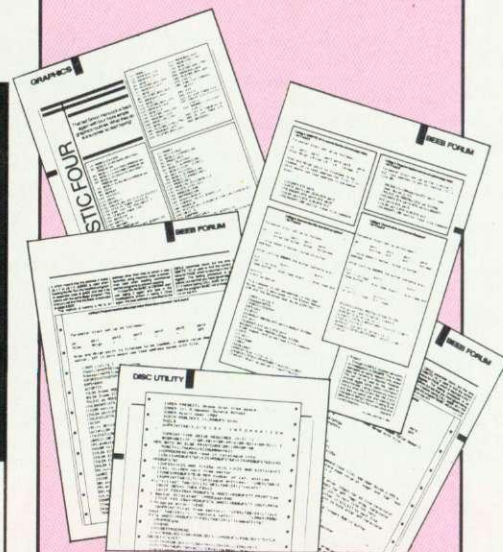

Save yourself the time and bother of typing in Acorn User listings

ORDER FORM ON PAGE 95

See 'High-Speed Random Numbers', page 106

Program 1. Subroutine used in Hi-Basic for producing a 32-bit pseudo-random number

```

10 P%=&C00
20 COPT 2
30
40 .newRND
50 LDY #4
60
70 .next_byte
80 ROR &11
90 LDA &10
100 PHA
110 ROR A
120 STA &11
130 LDA &0F
140 TAX
150 ASL A
160 ASL A
170 ASL A
180 ASL A
190 STA &10
200 LDA &0E
210 STA &0F
220 LSR A
230 LSR A
240 LSR A
250 LSR A
260 ORA &10
270 EOR &11
280 STX &10
290 LDX &0D
300 STX &0E
310 STA &0D
320 PLA
330 STA &11
340 DEY
350 BNE next_byte
360 RTS
370 J
380
390 Y%=1
400 REPEAT
410 CALL next_byte
420 PRINT ?&0D
430 UNTIL 0
440 END
450
460 REM or for 4 bytes.
470 REM don't need Y%
480
490 REPEAT
500 CALL newRND
510 PRINT !&0D
520 UNTIL 0
530 END

```

Program 2. Control software for the two hardware RNGs, plus tests to check their randomness

```

10 PROCinitialise
20 MODE4
30 REPEAT
40 PROCmenu
50 UNTIL end
60 CALL int_off
70 END
80
90 DEF PROCmenu
100 REM *****
110 CLS
120 PRINT"Analogue or digital? (0/1)"
130 INPUT "(or -1 to end.)" digital
140 IF digital<0 THEN end = 1 : ENDPROC
150 digital = -digital
160 analogue = NOT digital
170 PROCassemble_tests
180 INPUT"Histogram or map? (0 or 1)", map
190 IF analogue INPUT "Delay", delay%
200 IF analogue ?delaytime = delay%
210 IF digital CALL initialise_digital
220 IF analogue CALL initialise_analogue
230 IF map PROCdrawmap ELSE PROC histogram
240 ENDPROC
250
260 DEF PROCdrawmap
270 REM *****
280 CLS
290 CALL RNDmap
300 ENDPROC
310
320 DEF PROC histogram
330 REM *****
340 INPUT"How many sets of values", A%
350 Q% = A%
360 FOR M% = 0 TO 255
370 N%(M%) = 0
380 NEXT
390 REPEAT
400 CALL RND histogram
410 max% = 0 : min% = &FFFF : tot% = 0
420 FOR M% = 0 TO 255
430 N%(M%) = N%(M%)+?(B%+M%)+?(C%+M%)*256
440 tot% = tot%+N%(M%)
450 IF N%(M%)>max% max% = N%(M%)
460 IF N%(M%)<min% min% = N%(M%)
470 NEXT
480 CLS
490 PRINT"max ";max%;" min ";min%;
500 PRINT" ave ";tot%/256;" ";
510 R% = (max%-min%)/tot%*1280000
520 PRINT" range +/- ";R%/100;"% ";
530 FOR M% = 0 TO 255
540 PLOT69,M%*4,N%(M%)*3.8/Q%
550 NEXT
560 Q% = Q%+A%
570 UNTIL INKEY(0)>0
580 ENDPROC
590
600 DEF PROCerr_handle
610 REM *****
620 CALL int_off
630 REPORT
640 PRINT" at "ERL

```

Continued ▶

See 'High-Speed Random Numbers', page 106

```

● ◀ Continued
● 650 ENDPROC
● 660
● 670 DEF PROCinitialise
● 680 REM *****
● 690 DIM B% 256, C% 256, N%(255)
● 700 ON ERROR PROCerr_handle : END
● 710 oldIRQ = !&204 AND &FFFF
● 720 end = 0
● 730
● 740 REM Assemble RNG routines
● 750 REM *****
● 760 FOR opt% = 0 TO 2 STEP 2
● 770   P% = &C00
● 780   [OPT opt%
● 790
● 800   .initialise_digital
● 810   \*****
● 820   LDA #&88 \Shift in under system clock,
● 830   STA &FE6B \and Timer 1 one-shot on PB7.
● 840
● 850   LDA #&81 \Set PB0 + PB7 as outputs.
● 860   STA &FE62
● 870
● 880   LDA #18
● 890   STA &FE64 \Set delay time on Timer 1.
● 900   LDA #0
● 910   STA &FE65
● 920
● 930   LDA &FE6A \Dummy read of SR.
● 940
● 950   SEI
● 960   LDA #IRQ MOD 256 \ Interrupts
● 970   STA &204 \ are now
● 980   LDA #IRQ DIV 256 \ active.
● 990   STA &205
● 1000  CLI
● 1010  RTS
● 1020
● 1030  .IRQ
● 1040  \***
● 1050  LDA #1 \ Invert PB0 line.
● 1060  EOR &FE60
● 1070  STA &FE60
● 1080  JMP oldIRQ \ Back to IRQ routines.
● 1090
● 1100  .digRND
● 1110  \*****
● 1120  BIT &FE6D
● 1130  BVC digRND \ Timer 1 not timed out yet.
● 1140
● 1150  .digRNDnotWAIT \ Start here if > 20 uS
● 1160  LDX #0 \ since last access.
● 1170  STX &FE65 \ Start timer 1.
● 1180  \ = switch to CB2 clock.
● 1190  LDA &FE6A \ Read shift register.
● 1200  RTS
● 1210
● 1220  .int_off
● 1230  \*****
● 1240  SEI
● 1250  LDA #oldIRQ MOD 256
● 1260  STA &204 \ Restore original
● 1270  LDA #oldIRQ DIV 256
● 1280  STA &205 \ value of IRQ1V.
● 1290  CLI
● 1300  RTS
● 1310
● 1320  .initialise_analogue
● 1330  \*****
● 1340  LDA #&04 \ shift in under control
● 1350  STA &FE6B \ of Timer 2.
● 1360
● 1370  LDA delaytime
● 1380  STA &FE68 \ Set up value
● 1390  LDA #0 \ of Timer 2.
● 1400  STA &FE69
● 1410
● 1420  LDA &FE6A \ Dummy read of SR.
● 1430  RTS
● 1440
● 1450  .delaytime
● 1460  NOP \ Save one byte of space.
● 1470
● 1480  .anaRND
● 1490  \*****
● 1500  LDA #4
● 1510  .ready
● 1520  BIT &FE6D \ Has new value
● 1530  BEQ ready \ shifted in yet?
● 1540
● 1550  LDA &FE6A \ Read shift register.
● 1560  RTS
● 1570  ]
● 1580  NEXT
● 1590  tests% = P%
● 1600  ENDPROC
● 1610
● 1620  DEF PROCassemble_tests
● 1630  REM *****
● 1640  rndGEN = anaRND
● 1650  IF digital rndGEN = digRND
● 1660  FOR opt% = 0 TO 2 STEP 2
● 1670    P% = tests%
● 1680    [OPT opt%
● 1690
● 1700    .RNDmap
● 1710    \*****
● 1720    LDA #25
● 1730    JSR &FFEE \ PLOT,
● 1740
● 1750    LDA #69
● 1760    JSR &FFEE \ a single dot,
● 1770
● 1780    JSR rndGEN \ at, X low,
● 1790    JSR &FFEE
● 1800
● 1810    JSR rndGEN \ X high,
● 1820    AND #3
● 1830    JSR &FFEE
● 1840
● 1850    JSR rndGEN \ Y low,
● 1860    JSR &FFEE
● 1870
● 1880    JSR rndGEN \ Y high.
● 1890    AND #3
● 1900    JSR &FFEE
● 1910
● 1920    LDA #&81 \ Has a key
● 1930    LDX #0 \ been pressed?
● 1940    LDY #0
● 1950    JSR &FFF4
● 1960    BCS RNDmap
● 1970    RTS
● 1980
● 1990    .RNDhistogram
● 2000    \*****
● 2010    LDA #0
● 2020    TAX
● 2030    .wipe
● 2040    STA B%,X \ Write zeros into
● 2050    STA C%,X \ results table.
● 2060    INX
● 2070    BNE wipe
● 2080
● 2090    .sample
● 2100    JSR rndGEN \ Get a random
● 2110    TAX \ number in X register.
● 2120    INC B%,X \ Increment the counter.
● 2130    BNE sample
● 2140    INC C%,X \ Increment the next byte.
● 2150    LDA &404 \ A% = number of sets.
● 2160    CMP C%,X \ Enough yet?
● 2170    BNE sample \ If not, get another.
● 2180    RTS
● 2190    ]
● 2200    NEXT
● 2210  ENDPROC

```

Tessie Revivis' 'Fly in the Sky' program demonstrates use of elementary animation and sound

```

>PLEASE LIST THE PROGRAM
10 REM *** (c) Acorn User Sept.84 ***
20 dead_flag=1
30 MODE 0
40 VDU 23,1,0;0;0;0;
50 REPEAT
60 start=0 : finish=79 : step=1
70 PROCfly
80 IF dead_flag=0 THEN END
90 start=79: finish=0 : step=-1
100 PROCfly
110 IF dead_flag=0 THEN END
120 UNTIL 0
130 :
140 *** procedures here ***
150 :
160 DEF PROCfly
170 FOR pos=start TO finish STEP step
180 PRINTTAB(pos,3);"*";
190 SOUND0,-15,2,1
200 key$=INKEY$(0)
210 IF key$=" " THEN PROCdie (pos)
220 FOR delay=0 TO 50 : NEXT
230 PRINTTAB(pos,3);" ";
240 IF dead_flag=1 NEXT
250 ENDPROC
260 :
270 :
280 DEF PROCdie (pos)
290 P=pos:pos=finish:NEXT
300 dead_flag=0
310 *FX21,4
320 PRINTTAB(P,3);" ";
330 FOR down=3 TO 32
340 SOUND0,-15,3,1
350 PRINT TAB(P,down);"*";
360 FOR delay=0 TO 50 : NEXT
370 PRINT TAB(P,down);" ";
380 NEXT
390 *FX21,4
400 SOUND0,-15,6,10
410 ENDPROC
    
```



III

The procedures behind Michael Why's 'Paranoids', explained step by step in his article

```

10 REM *****
20 REM *** PARAS by Michael Why ***
30 REM *** (c) Acorn User Sept.84 ***
40 REM *****
50 DIM PARAY%(30),PARAX%(30),X%(30),Y
%(30),PARA$(30)
60 PROCINIT
70 MODE2
80 MODE4:VDU23;8202;0;0;0;
90 REPEAT
100 REPEAT
110 PROCTANK
120 PROCTANK
130 PROCPARAS
140 PROCTANK
150 UNTIL HITZ+1=PARAX OR LIFEZ=1
160 PROCLEVEL
170 UNTIL LIVESZ=3
180 MODE6
190 END
200 :
210 DEFPROCINIT
220 Z=0:PARAZ=4:HITZ=0:LANDZ=0:SCOREZ=
0:LIFEZ=0:LIVESZ=0:LEVELZ=1
230 VDU23,224,155,155,195,60,24,24,36,
195,23,225,60,126,255,255,129,66,36,0
240 FORLZ=1TOPARAZ:PARA$(LZ)=CHR$225+C
HR#10+CHR#8+CHR$224:NEXT
250 VDU23,226,1,1,7,63,127,161,115,33,
23,227,128,128,224,252,254,133,206,132
260 VDU23,228,231,36,60,66,153,153,66,
36,23,229,36,66,153,153,66,60,36,231
270 SPACE#=CHR$32+CHR#10+CHR#8+CHR$32
280 explode#=CHR$228+CHR#10+CHR#8+CHR#
229
290 tank#=CHR$226+CHR$227
300 VDU23,1,0;0;0;0;
310 FORLZ=1TOPARAZ:X%(LZ)=RND(3)-2:Y%(
LZ)=1:NEXT
320 TZ=20
330 FIREZ=0:FORLZ=1TOPARAZ:PARAX%(LZ)=
RND(27)+5:PARAY%(LZ)=2:NEXT
340 IFPARAX%(LZ)=PARAX%(LZ-1) THENPARAX
%(LZ)=PARAX%(LZ)-1
350 ENDPROC
360 :
370 DEFPROCTANK
380 IFINKEY(-85) THENREPEATUNTILINKEY(-
67)
390 IFSCOREZ<0THENSCOREZ=0
400 PRINTTAB(8,1);" "
410 PRINTTAB(2,1);"SCORE=";SCOREZ;TAB(
14,1);"LIVES LOST=";LIVESZ;TAB(29,1);"LE
VEL=";LEVELZ
420 PRINTTAB(TZ,29);" "
430 *FX15,1
440 IFINKEY(-67)ANDTZ<=35
THENTZ=TZ+1:Z=1
450 IFINKEY(-98)ANDTZ>=5
THENTZ=TZ-1:Z=1
460 PRINTTAB(TZ,29);tank#
470 IFZ=0THENENDPROC
480 Z=0
490 ENDPROC
500 :
510 DEFPROCPARAS
520 VDU20
530 VDU19,1,3,0,0,0
540 LZ=1
550 IFPARA$(LZ)=SPACE#THEN630
560 COLOUR1
570 IFPARAY%(LZ)>=27THENPRINTTAB(PARAX
%(LZ),PARAY%(LZ));SPACE#:PARAY%(LZ)=2:PA
RAX%(LZ)=PARAX%(LZ):LANDZ=LANDZ+1:SCOREZ
=SCOREZ-100:IFLANDZ>=1THENPROCNEW_LIFE
580 IFPARAX%(LZ)>=35THENPRINTTAB(PARAX
%(LZ),PARAY%(LZ));SPACE#:PARAX%(LZ)=3
590 IFPARAX%(LZ)<=2THENPRINTTAB(PARAX%
(LZ),PARAY%(LZ));SPACE#:PARAX%(LZ)=35
600 PRINTTAB(PARAX%(LZ),PARAY%(LZ));SP
ACE#
610 PARAX%(LZ)=PARAX%(LZ)+X%(LZ):PARAY
%(LZ)=PARAY%(LZ)+Y%(LZ)
620 PRINTTAB(PARAX%(LZ),PARAY%(LZ));PA
RA$(LZ)
630 PROCFIRE
640 IFLZ<>PARAZTHENZ=LZ+1
650 IFLZ<>PARAZTHENGOTO550ELSEGOTO660
    
```



Continued ▶

See pages 37 and 45

◀ Continued

```

660 ENDPROC
670 :
680 DEFPROC FIRE
690 FIREX%=TX
700 IFNOTINKEY(-99) THENENDPROC
710 ENVELOPE2,1,-12,-6,-3,3,6,12,126,0
,0,-126,126,126
720 SOUND&11,2,200,4
730 tank_base%=32*T%+32
740 MOVE tank_base%,90
750 DRAW tank_base%,32*(31)
760 PLOT7,tank_base%,90
770 FIRE%=0
780 IFFARAX%(L%)=FIREX%ORPARAX%(L%)-1=
FIREX% THENPROCXPLODE
790 ENDPROC
800 :
810 DEFPROCXPLODE
820 SCORE%=SCORE%+50
830 PRINTTAB(PARAX%(L%),PARAY%(L%));SP
ACE#
840 ENVELOPE2,2,-12,0,-3,3,6,12,126,0,
0,-126,126,126
850 SOUND&11,2,255,12
860 PRINTTAB(PARAX%(L%),PARAY%(L%));ex
plode#
870 TIME=0:REPEATUNTILTIME>25
880 PRINTTAB(PARAX%(L%),PARAY%(L%));SP
ACE#
890 PARA#(L%)=SPACE#
900 PARAX%(L%)=3:PARAY%(L%)=2:X%(L%)=0
:Y%(L%)=0:HIT%=HIT%+1
910 ENDPROC
920 :
930 DEFPROCLEVEL
940 IFLIVES%=3 THENPROCGAME_LOST
950 LEVEL%=LEVEL%+1
960 IFLAND%=0 THENSCORE%=SCORE%+50
970 PARAX%=PARAX%+1
980 FORL%=1TOPARAX%:PARAX%(L%)=RND(27)+
5:PARAY%(L%)=2:X%(L%)=RND(3)-2:Y%(L%)=1:
NEXT
990 HIT%=0
1000 FORL%=1TOPARAX%:PARA#(L%)=CHR#225+C
HR#10+CHR#8+CHR#224:NEXT
1010 ENDPROC
1020 :
1030 DEFPROCNEW_LIFE
1040 LIFE%=LIFE%+1
1050 LIVES%=LIVES%+LIFE%
1060 IFLIFE%=1 THENPROCTANK_LOST
1070 IFLIVES%=3 THENPROCGAME_LOST
1080 LAND%=0
1090 LIFE%=0
1100 ENDPROC
1110 :
1120 DEFPROCTANK_LOST
1130 LAND%=0:A%=0
1140 CLS
1150 PRINTTAB(14,15);"LIFE LOST":SOUND1
,-15,150,5
1160 TIME=0:REPEATUNTILTIME=100
1170 CLS
1180 IFLIVES%=3 THENPROCGAME_LOST
1190 ENDPROC
1200 :
1210 DEFPROCGAME_LOST
1220 IFScore%<0 THENSCORE%=0
1230 PRINTTAB(14,8);"YOUR SCORE=";SCORE
%
1240 PRINTTAB(4,12);"PRESS SPACE TO STA
RT OR E TO END"
1250 REPEAT
1260 IFINKEY(-99) THENRUN
1270 IFINKEY(-35) THENCLS:END
1280 UNTILINKEY(-99)ORINKEY(-35)
1290 ENDPROC
1300 :
1310 DEFPROCDELAY:TIME=0:REPEATUNTILTIM
E=17:ENDPROC

```

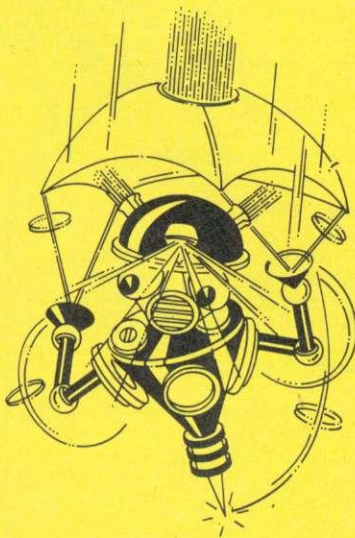
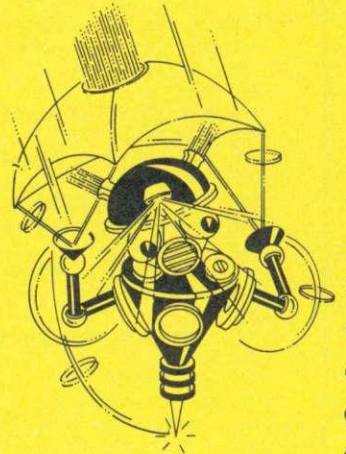

Listing 1.

```

10 REM Listing 1
20 REM Run this program before using function keys
30 *KEY0
L$="L."+STR$ LZ+", "+STR$(LZ+9)+CHR$12+CHR$13:A%=138:X%=0:FOR Z%=1 TO
LEN L$:Y%=ASC(MID$(L$,Z%)):CA.&FFF4:N.:L%=LZ+10:IM
40 *KEY1 IN."List from",LZ:LI:M
    
```

Listing 2.

```

10 REM Listing 2
20 A$=""
30 FOR N%=1 TO 10
40 REPEAT:B$=STR$(RND(10)-1)
50 UNTIL INSTR(A$,B$)=0
60 A$=A$+B$+" "
70 NEXT N%
80 PRINT A$
    
```

Listing 3

```

10 REM Listing 3
20 MODE7
30 DIM X(10)
40 A=1
50 REPEAT
60 T=RND(10):Q=1
70 IF X(Q)=T THEN 60
80 Q=Q+1
90 IF Q<10 THEN 70
100 X(A)=T:A=A+1
110 UNTIL A>10
120 FOR P=1 TO 10
130 PRINT X(P)
140 NEXT
    
```

Listing 4

```

10 REM Listing 4
20 TIME = 0
30 FOR T=1 TO 100
40 A$=""
50 FOR N%=1 TO 10
60 REPEAT:B$=STR$(RND(10)-1)
70 UNTIL INSTR(A$,B$)=0
80 A$=A$+B$+" "
90 NEXT N%
100 PRINT A$
110 NEXT T
120 PRINT "Time = ";TIME/100;"
centiseconds"
    
```

Listing 5

```

10 REM Listing 5
20 A$=""
30 FOR N%=1 TO 13
40 REPEAT:B$=STR$(RND(13))
50 IF B$="10" THEN B$="J"
60 IF B$="11" THEN B$="Q"
70 IF B$="12" THEN B$="K"
80 UNTIL INSTR(A$,B$+" ")=0
90 A$=A$+B$+" "
100 NEXT N%
110 PRINT A$
    
```

Listing 6

```

10 REM Listing 6
20 A$=""
30 DIM suit$(4)
40 suit$(1)="H":suit$(2)="C"
50 suit$(3)="D":suit$(4)="S"
60 FOR N%=1 TO 52
70 REPEAT
80 C$=suit$(RND(4))
90 B$=STR$(RND(13))
100 IF B$="11" THEN B$="J"
110 IF B$="12" THEN B$="Q"
120 IF B$="13" THEN B$="K"
130 B$=C$+"-"+B$
140 UNTIL INSTR(A$,B$+" ")=0
150 A$=A$+B$+" "
160 NEXT N%
170 PRINT A$
    
```

Listing 7

```

10 REM Listing 7
20 A=3.2
30 B=6.4
40 C=9.6
50 IF A+B=C PRINT"Correct"
60 PRINT"I've finished"
    
```

Listing 8

```

10 REM Listing 8
20 A=3
30 B=6.4
40 C=9.4
50 IF A+B=C PRINT"Correct"
60 PRINT"I've finished"
    
```

HINTS & TIPS

See pages 48, 50 and 52

Listing 9

```
10 REM Listing 9
20 A=3
30 B=6.4
40 C=9.4
50 IF A+B=C PRINT "Correct"
60 PRINT "A = ";A
70 PRINT "B = ";B
80 PRINT "C = ";C
```

Listing 10

```
10 REM Listing 10
20 @%=&20200
30 amount%=0
40 PRINT "Press 0 to end"
50 REPEAT
60 INPUT "Amount in pounds and pence
   £"amount
70 amount%=amount%+amount*100
80 UNTIL amount=0
90 INPUT "Enter total £"total
100 total%=total*100
110 IF amount%=total% PRINT
   "Figures agree"
120 PRINT "£"amount%/100
   .£"total%/100
```

VI

Listing 11

```
10 REM Listing 11
20 @%=0
30 tot=0
40 PRINT "Press 0 to end"
50 REPEAT
60 INPUT "Amount in pounds and pence
   £"amount
70 tot=tot+amount
80 UNTIL amount=0
90 INPUT "Enter total £"total
100 IF ABS(tot-total)<0.001 PRINT
   "Figures agree"
110 PRINT "£"tot"      £"total
```

Listing 12

```
10 REM Listing 12
20 *KEY10 OLD:IM *TAPE:IM RUN:IM
30 ON ERROR GOTO 60
40 *OPT2,1
50 PRINT "Tape system"
60 IF ERL=40 THEN PRINT "Disc system"
70 ON ERROR OFF
```

Listing 13

```
10 REM Listing 13
20 VDU2,1,32,1,32,3
30 IF ADVAL(-4)=63 THEN PRINT "PRINTER
   CONNECTED"
```

Listing 15

```
10 REM Listing 15
20 REM Fast circle drawing
30 REM Electron 1.59sec, BBC 0.49sec
40 MODE1
50 PROCsetup
60 TIME=0
70 PROCcircle
80 PRINT TIME/100;"sec"
90 END
100 :
110 DEFPROCsetup
120 VDU29,640;512;
130 R%=400
140 DIM cos(60),sin(60)
150 FOR A%=1 TO 60
160 cos(A%)=COS(A%*PI/30)
170 sin(A%)=SIN(A%*PI/30)
180 NEXT
190 ENDPROC
200 :
210 DEFPROCcircle
220 MOVE R%,0
230 FOR A%=1 TO 60
240 DRAW R%*cos(A%),R%*sin(A%)
250 NEXT
260 ENDPROC
```

Listing 14

```
10 REM Listing 14
20 REM Fast circle drawing
30 REM Electron 3.99sec, BBC 1.28sec
40 TIME=0
50 MODE1
60 VDU29,640;512;
70 R%=400
80 c=COS(PI/30):s=SIN(PI/30)
90 oc=1:os=0
100 MOVE R%*oc,R%*os
110 FOR A%=1 TO 60
120 nc=oc*c-os*s
130 ns=os*c+oc*s
140 DRAW R%*nc,R%*ns
150 oc=nc:os=ns
160 NEXT
170 PRINT TIME/100;"sec"
```

KALEIDOSCOPE

REMEMBER those cardboard tubes containing coloured chips which reflected in a mirror system to produce random but regular patterns? No, nor do we. But they were popular Victorian toys and enjoyed a revival some years ago. Now Christopher Johnston puts the same effects onto the screen with this *Kaleidoscope* program. *Kaleidoscope* provides up to 16 different rotating swirls of colour for BBC Model B and Electron owners.

After entering the program run it and input a number from 1 to 16 as requested. The kaleidoscope base will generate before your very eyes by plotting eight squares of the same colour symmetrically about the mode 2 screen. The screen takes about three minutes to fill before its contents begin to rotate and flash in an ever-changing pattern.

The < and > keys can be used to speed up the direction of rotation either left or right and pressing the space bar freezes the display for closer inspection. The RETURN key allows you to set all colours to black if the program dazzles you with its brilliance!

```

10 REM ***      KALEIDOSCOPE  ***
20 REM ***      by C. Johnston  ***
30 REM ***      (c) Acorn User  ***
40 MODE6
50 PROCinit
60 MODE2
70 PROCpattern
80 REPEAT
90 K%=INKEY(0)
100 IF K%>0 THEN PROCkey
110 IF D%>5 THEN PROCforward ELSE PROC
reverse
120 UNTIL FALSE
130 DEFPROCinit
140 DIM C%(15),D%(10)
150 FOR D%=0 TO 10
160 D%(D%)=100-(D%-5)*(D%-5)*4
170 NEXT
180 N%=-1
190 REPEAT
200 N%=N%+1
210 READ F#
220 UNTIL F#=""
230 REPEAT
240 PRINT"WHICH PATTERN: (1-";N%;") ";
250 INPUT F%
260 UNTIL F%>=1 AND F%<=N%
270 RESTORE
280 FOR L%=1 TO F%
290 READ F#
300 NEXT
310 DATA 6E6 DIV ((X%-604)*(Y%-60)*(X%
-Y%-100))
320 DATA 5E7 DIV ((X%-204)*(Y%-300)*(X
%-Y%-300))
330 DATA 5E4 DIV ((Y%-60)*(Y%-X%+204))
340 DATA 1.2E5 DIV ((Y%+1)*(Y%-X%-1))
350 DATA 1E6 DIV ((Y%+1)*(Y%-X%-1))
360 DATA 1E5 DIV ((X%-404)*(Y%-150))
370 DATA 3E8 DIV ((X%+500)*(Y%+500))
380 DATA 100*(Y%+8) DIV (X%+8)
390 DATA 1000*(Y%+8) DIV (X%+8)
400 DATA 1200*(X%+350) DIV (Y%+500)
410 DATA X%*(Y%+1) DIV 40
420 DATA X%*(Y%+1) DIV 80
430 DATA X%*(Y%+1) DIV 200
440 DATA X%*(Y%+5) DIV 1000
450 DATA (X%*X%+Y%*Y%) DIV 1000
460 DATA (X%*X%*X%+Y%*Y%*Y%) DIV 1E5
470 DATA ""
480 *FX9,50
490 *FX10,50
500 D%=10
510 ENDPROC
520 DEFPROCpattern
530 VDU23,1,0;0;0;0;
540 VDU29,640;512;
550 FOR Y%=0 TO 512 STEP 8
560 FOR R%=1 TO 3
570 VDU19,RND(15),RND AND 15;0;
580 NEXT
590 FOR X%=Y% TO 640 STEP 8
600 GCOL0,EVAL(F#) AND 15
610 FOR A%=-1 TO 1 STEP 2
620 FOR B%=-1 TO 1 STEP 2
630 PLOT69,X%*A%,Y%*B%
640 PLOT65,0,4
650 PLOT69,Y%*B%,X%*A%
660 PLOT65,0,4
670 NEXT
680 NEXT
690 NEXT
700 NEXT
710 ENDPROC
720 DEFPROCkey
730 REPEAT
740 IF (K%=46 OR K%=62) AND D%<10 THEN
D%=D%+1
750 IF (K%=44 OR K%=60) AND D%>0 THEN
D%=D%-1
760 IF K%=32 THEN D%=5
770 IF K%=13 THEN PROCblack
780 K%=INKEY(0)
790 UNTIL D%<>5
800 *FX15,1
810 ENDPROC
820 DEFPROCforward
830 P%=FNrnd(0)
840 FOR L%=0 TO 15
850 FOR W%=1 TO D%(D%)
860 NEXT
870 VDU19,L%,P%;0;
880 C%=C%(L%)
890 C%(L%)=P%
900 P%=C%
910 NEXT
920 ENDPROC
930 DEFPROCreverse
940 P%=FNrnd(15)
950 FOR L%=15 TO 0 STEP-1
960 FOR W%=1 TO D%(D%)
970 NEXT
980 VDU19,L%,P%;0;
990 C%=C%(L%)
1000 C%(L%)=P%
1010 P%=C%
1020 NEXT
1030 ENDPROC
1040 DEFFNRND(C%)
1050 R%=(RND AND 3)*(RND AND 1)
1060 IF R%=3 THEN R%=4
1070 =C%(C%) EDR R%
1080 DEFPROCblack
1090 FOR L%=0 TO 15
1100 FOR W%=1 TO 200
1110 NEXT
1120 VDU19,L%,0;0;0;
1130 C%(L%)=0
1140 NEXT
1150 FOR W%=1 TO 2000
1160 NEXT
1170 ENDPROC

```

See 'Spritely Characters', pages 74-79

Harry Sinclair's sprite generator program, 'Design'.
Turn to page x for instructions on entering it and
converting for the Electron

```

1 REM *****
2 REM *** (c) Acorn User Sept.1984
3 REM *** DESIGN by Harry Sinclair
4 REM *****
5 REM ** IMPORTANT: Set PAGE=&1900
6 REM *****
10 *KEY10?&224=&A6:MPA.=&1900:MOLD:IM
20 *TV255
30 ONERROR PROCwind_up:END
40 MODE7
50 FORI%=0TO1:PRINTTAB(7,3+I%)CHR$129
+CHR$157+CHR$141+CHR$135"SPRITE DESIGN"+
CHR$9+CHR$9+CHR$9+CHR$156:NEXT
60 PRINTTAB(0,7)" You may design char
acters with a width of between 8 and 20
pixels - only even numbers are allowed"
""Please enter width : "
70 REPEATPRINTTAB(20,11)SPC(26);:INPU
TTAB(20,11)" W%:UNTILW%>7ANDW%<21 AND N
DTW%MOD2
80 W%=W%/2:IFW%=4 RESTORE110 ELSEIFW%
=5 RESTORE120 ELSE RESTORE130
90 FORI%=&12F0 TO&12FF STEP 2:READA$:
!IX=EVAL("&"+A$):NEXT
100 ?&12EF=W%*8
110 DATA1300,1360,1300,1400,1460,1500,
1460,1560
120 DATA1300,1378,1300,1400,1478,1500,
1478,1578
130 DATA1300,1400,1300,1500,1600,1700,
1600,1800
140 cha%=0:table%=&12F0:end%=FALSE
150 *FX4,1
160 MODE2:VDU23,1,0;0;0;0;0;
170 VDU23,240,0,0,&F0,&F0,&F0,&F0,0,0,
23,241,0,0,&40,&E0,&40,0,0,0
180 FORI%=0TO&5FF STEP4:I%!=1300=0:NEX
T
190 PROCassemble
200 key$="0123456789ABCDEF"
210 REPEAT
220 I%=cha%*2:base%=I%?&12F0+I%?&12F1*
256+8
230 space%=(80-?&12EF DIV8*7)DIV8
240 CLG:IF cha%<0:?&71=space%:FORI%=0
TO cha%-1:?&70=I%:?&72=16:CALL display:?
&71=?&71+W%/2+space%:NEXT
250 VDU28,0,22,7,9,4
260 VDU30:COLOUR7:PRINT"KEYS"
270 @%=0:PRINTTAB(0,2)"0";TAB(2);"8";:
COLOUR8:PRINTCHR$240:FORI%=1TO7:COLOURI%
:PRINTI%;CHR$240;~I%+8;:COLOURI%+8:PRINT
CHR$240:COLOURI%-1:NEXT
280 VDU28,0,31,19,21
290 COLOUR6:PRINTTAB(2,0)"Press TAB wh
en"";TAB(2)"design finished":COLOUR3
300 PRINT'TAB(1)"Use cursor keys to""
" position pointer"
310 W%=?&12EF/4:VDU29,440-8*(W%-8)-8;4
00;:MOVE0,0
320 PLOT21,0,12*32+6:PLOT29,W%*32+8,12
*32+6:PLOT21,W%*32+8,0:PLOT29,0,0
330 GCOL0,7
340 X%=8:Y%=24
350 PROCpntr (X%,Y%)
360 REPEAT
370 K%=INSTR(key$,GET$)
380 IF K%<0 col%=K%-1:PROCdraw(col%,X
%,Y%):PROCpntr (X%,Y%)
390 IFINKEY(-58)ANDY%<384 PROCpntr (X%,
Y%):Y%=Y%+16:PROCpntr (X%,Y%)
400 IFINKEY(-42)ANDY%>24 PROCpntr (X%,Y

```

```

%):Y%=Y%-16:PROCpntr (X%,Y%)
410 IFINKEY(-26)ANDX%>8 PROCpntr (X%,Y%
):X%=X%-32:PROCpntr (X%,Y%)
420 IFINKEY(-122)ANDX%<32*(W%-1) PROCp
ntr (X%,Y%):X%=X%+32:PROCpntr (X%,Y%)
430 UNTILINKEY(-97)
440 cha%=cha%+1:IFcha%=2 cha%=3 ELSE I
Fcha%=6 cha%=7
450 VDU4,12,23,1,0;0;0;0;0;
460 IF cha%=8 PRINTTAB(2,0)"8 chars. d
efined.";TAB(4,2)"No more room.";TAB(2,7
);:COLOUR3:PRINT"SPACE to continue":end%
=TRUE:ELSE PRINTTAB(7,2)"press";TAB(1,4)
;:COLOUR3:PRINT" SPACE to continue";TAB(
2,6);:COLOUR6:PRINT" CTRL Z to exit "
470 REPEATG=GET:UNTILG=&20 ORG=&1A:IFG
=&1A end%=TRUE
480 UNTIL end%
490 *FX4
500 MODE7
510 @%=4
520 PRINTTAB(0,2)" Data goes from"CHR$
134"&1300"CHR$135"to"CHR$134;"&";~base%+
3*?&12EF:PRINT';CHR$131;cha%;CHR$135;"c
haracters defined"CHR$131;"(0 to ";cha%-
1;")."
530 PRINT"" Table of addresses is @";
CHR$130;"&12F0";CHR$135;"to";CHR$130;"&
";~&12F0+cha%*2-1
540 PRINT"" Do you want to save the d
ata and the "" address table (Y/N)?":R
EPEATG=GET OR&20:UNTILG=&79 OR G=&6E
550 IFG=&79 PROCsave
560 PRINT'TAB(14)"Bye Bye"
570 END
575 :
580 DEFPROCpntr (X%,Y%)
590 VDU5
600 MOVEX%,Y%
610 GCOL3,7
620 PRINTCHR$241
630 ENDPROC
640 DEFPROCdraw(col%,X%,Y%)
650 VDU5
660 MOVEX%,Y%
670 ?&88=(X%-6)DIV32:?&89=23-((Y%-24)D
IV16):?&87=col%:address?1=base%MOD256:ad
dress?2=base%DIV256:store?3=base%MOD256:
store?4=base%DIV256
680 !&70=&4F78+(?&12EF*2)
690 GCOL0,col%
700 PRINTCHR$240
710 CALL byte_number
720 ENDPROC
725 :
730 DEFPROCwind_up
740 *FX4
750 VDU4:COLOUR7
760 PRINT"ERROR ";ERR;" @ LINE ";ERL;:
REPORT:PRINT
770 ENDPROC
775 :
780 DEFPROCsave
790 PRINT"" What do you want to call
the file?"CHR$136;"(max. 7 letters - no
quotes needed)"
800 REPEAT:PRINTTAB(14,16)SPC(20):INPU
TTAB(14,16)" "data$:UNTILLENdata$<=7
810 FORI%=&3000 TO&3030:~I%=0:NEXT
820 DX=&3000
830 $(DX+&20)=data$:?DX=&20:DX?1=&30
840 DX?2=&EE:DX?3=&12
850 DX?A=&EE:DX?B=&12
860 DX?E=(base%+(3*?&12EF)+1)MOD256
870 DX?F=(base%+(3*?&12EF)+1)DIV256
880 AX=0:XX=0:Y%=&30
890 PRINT" Press RETURN when you're re
ady.""

```

Continued ▶

900 REPEATUNTILGET=13	1600 LDA&85	2310 STA&84
910 CALL&FFDD	1605 \ dummy address	2320 LDA#2
920 PRINT " Data saved	1610 STA &B000,X	2330 ADC&83
as "data\$	1620 LDA#0	2340 STA&85
930 ENDPROC	1630 STA&86	2350 LDA##&80
935 :	1640 STA&87	2360 CLC
940 DEFPROCassemble	1650 LDY&8D	2370 ADC&84
950 FORI%=0TO2 STEP2	1660 LDA&85	2380 STA&86
960 P%=&1100	1670 STA(&70),Y	2390 LDA#2
965 REM Square bracket	1680 RTS	2400 ADC&85
printed as left	1690 .pixad	2410 STA&87
arrow in Mode7	1700 DEX	2420 LDA&70
970 [OPTI%	1710 BMI end	2430 ASLA
980 .byte_number	1720 LDA&70	2440 TAY
990 LDA&89	1730 CLC	2450 LDA&12F0,Y
1000 AND#7	1740 ADC##&80	2460 CLC
1010 STA&8F	1750 STA&70	2470 ADC#8
1020 LDA&89	1760 LDA&71	2480 LDX#0
1030 AND##&FB	1770 ADC#2	2490 STA&88,X
1040 LSRA:LSRA:LSRA	1780 STA&71	2500 CLC
1050 TAY	1790 LDA&8D	2510 .loop2
1060 LDX#0	1800 SEC	2520 ADC&12EF
1070 DEY	1810 SBC&12EF	2530 INX
1080 BMI no_add	1820 STA&8D	2540 INX
1090 LDA&12EF	1830 JMP pixad	2550 CPX#8
1100 INX	1840 .end	2560 BCS over
1110 DEY	1850 RTS	2570 STA&88,X
1120 BMI no_add	1860 .display	2580 BCC loop2
1130 INX	1870 LDA#0	2590 .over
1140 CLC	1880 STA&81	2600 CLC
1150 ADC&12EF	1890 LDA##&30	2610 INY
1160 .no_add	1900 STA&83	2620 LDA&12F0,Y
1170 CLC	1910 LDA&71	2630 LDX#0
1180 ADC&8F	1920 ASLA	2640 .loop3
1190 STA&8F	1930 ROL&81	2650 STA&89,X
1200 LDA&88	1940 ASLA	2660 INX
1210 AND##&FE	1950 ROL&81	2670 INX
1220 ASLA	1960 ASLA	2680 CPX#8
1230 ASLA	1970 ROL&81	2690 BCC loop3
1240 CLC	1980 STA&82	2700 LDY&12EF
1250 ADC&8F	1990 LDA&81	2705 \ draws character
1260 STA&8F	2000 CLC	2710 .mainloop
1270 STA&8D	2010 ADC&83	2720 TYA
1280 JSR pixad	2020 STA&83	2730 BEQ out
1290 .byte_value	2030 LDA&72	2740 DEY
1300 LDX&8F	2040 AND#7	2750 LDA(&88),Y
1310 .address	2050 EOR&72	2760 BEQ block2
1315 \ dummy address	2060 LSRA	2770 STA(&80),Y
1320 LDA &B000,X	2070 STA&81	2780 .block2
1330 STA&86	2080 LSRA	2790 LDA(&8A),Y
1340 LDA#0	2090 LSRA	2800 BEQ block3
1350 STA&85	2100 ADC&81	2810 STA(&82),Y
1360 LDY#4	2110 LSRA	2820 .block3
1370 CLC	2120 STA&81	2830 LDA(&8C),Y
1380 LDA&88	2130 LDA#0	2840 BEQ loopend
1390 LSRA	2140 RORA	2850 STA(&84),Y
1400 BCC even	2150 CLC	2860 .loopend
1410 CLC	2160 ADC&82	2870 JMP mainloop
1420 .odd	2170 STA&80	2880 .out
1430 ROR&86	2180 LDA&81	2890 RTS
1440 ROR&87	2190 ADC&83	2900]
1450 ROR&85	2200 STA&81	2910 NEXT
1460 ROR&86	2210 LDA##&80	2920 ENDPROC
1470 ROR&85	2220 CLC	
1480 DEY	2230 ADC&80	
1490 BNE odd	2240 STA&82	
1500 JMP store	2250 LDA#2	
1510 .even	2260 ADC&81	
1520 ROR&86	2270 STA&83	
1530 ROR&85	2280 LDA##&80	
1540 ROR&86	2290 CLC	
1550 ROR&87	2300 ADC&82	
1560 ROR&85		
1570 DEY		
1580 BNE even		
1590 .store		

Instructions ►

See 'Spritely Characters', pages 74-79

RUNNING DESIGN

THE 'Design' listing is one of the longest programs we've presented in *Acorn User*. To enable you to enter the program from the keyboard we have devised tests that we hope will reduce the number of typing errors you make in entering it, so that you can get it running with the minimum of effort.

The program can be broken down into two sections, Basic and assembly language. If you have never programmed in assembler before don't worry - a knowledge of its workings is not necessary for just typing it in exactly as you see it. But before starting ensure that PAGE has been set to &1900, whether you have tape or disc. To do this type:

```
PAGE = &1900 < return >
NEW < return >
```

From a debugging point of view you will find it a lot easier to enter the assembler listing first. This comprises lines 940 to 2920 inclusive. Long assembler listings tend to repeat themselves so it is easy to enter the wrong commands. To avoid this, use a small rule, preferably not transparent, to mark the line you are currently entering and move it down line by line. It saves time if you program the function keys with the most frequently used commands. Just write each key's pre-programmed command on a strip of paper and place it under the plastic strip above the function keys. We suggest this combination:

```
*KEY0 LDA
*KEY1 STA
*KEY2 INX
*KEY3 DEY
*KEY4 CLC
*KEY5 ROR
*KEY6 ROL
*KEY7 ADC
*KEY8 LSR
*KEY9 LDX
```

To facilitate entry of the assembler listing type:

```
AUTO 940 < RETURN >
```

and enter each line as prompted. This will prompt you with line numbers that increase in steps of 10. However, four of the program lines contain REM statements on odd line numbers. These are: 965, 1315, 1605, and 2705. They should be omitted when you first enter the program. If you want, enter them last of all, typing in each line number and the REM separately. The lines are not vital to the program's operation so may be left out. When the assembler listing is safely keyed in hit the Escape key and then re-enter line 950 as follows:

```
950 FOR 1% = 0 TO 3 STEP 3
```

and add the following two lines to the program:

```
1 PROCassemble
2 END
```

Now RUN the program. If any errors in syntax are present a suitable error message will be generated informing you of the number of the line containing the error, which can then be checked against the listing and edited. This check ensures that a syntactically correct assembler listing is present. Assembler being what it is though, problems could occur if, say, you typed in TAY instead of TYA. These mnemonics use the same letters but work in opposite directions. To ensure against such an error add the following lines to the assembler program:

```
1 PROCassemble
2 Z% = 0
3 FOR N% = &1100 TO &123B
4 Z% = Z% + ?N%
5 NEXT
6 PRINT "CHECKSUM IS :";Z%
7 END
```

Next run the program. After a short delay the result

```
CHECKSUM IS: 36468
```

should be produced. These few lines have added together all of the machine code bytes. If your checksum result is different check through your assembler program again.

Once you are sure your assembler listing is correct delete lines 1 to 7 inclusive and re-enter line 950 as it appears in the listing:

```
950 FOR 1% = 0 TO 2 STEP 2
```

Now enter the rest of the Basic program as normal. An ON ERROR trap has been incorporated into this main part so that detailed error messages will be displayed if any occur at run time. When debugging it is worth producing the standard *Acorn User* format listing to screen or printer to help you. To do this first type:

```
WIDTH 40
```

and then list in the usual way. If you've entered the listing exactly as published it should be a simple matter to whizz down it comparing yours line for line.

Finally, if all this looks like too much work there's the *Acorn User* cassette of all the major programs in this issue. A full facility sprite designer - not to mention all the other useful routines elsewhere in the mag - has to be great value at only £3.95!

CONVERTING FOR THE ELECTRON

'DESIGN' can be run successfully on the Electron if a few alterations are made to the listings. Only one actually needs to be made to ensure the running of the program. The other changes are purely cosmetic.

The important change is in line 430. This command tests whether the TAB key has been pressed. Now Elkies will know that their machine does not have a TAB key so we need to specify a key to replace the TAB key. We suggest the DELETE key. To do this re-enter line 430 to read:

```
430 UNTIL INKEY (- 90)
```

Alternatively, the COPY key could be specified, using the following:

```
430 UNTIL INKEY (- 106)
```

Whichever you choose, you might also like to adjust the program prompt in line 290 to DELETE or COPY in place of TAB. If the DELETE key is being used, line 290 should read:

```
290 COLOUR6:PRINT TAB(2,0) "Press DELETE when" "
```

followed by the remainder of the line. Be sure to change the TAB inside the quotes and not the print formatting one before it.

The other changes generally involve the use of the Beeb's teletext screen to produce double-height characters. An example is given in line 50 to print SPRITE DESIGN in large teletext letters. The whole of this line could be replaced by a single line:

```
50 PRINT TAB(7,3) "SPRITE DESIGN"
```

on the Electron.

Any other adjustments you care to perform can be done after first running through the program and noting where the changes are that you wish to make.

Finally, line 10 is rather Beeb-specific, as it relates to the Econet system. If this is entered and BREAK hit the Elk will print a lot of gobbledegook and hang up. To avoid this retype line 10 as follows:

```
10 *KEY 10 PA. = &1900IMOLDIM
```

Happy designing!

Program 1. One way of solving the currency conversion problem. Four countries are involved

```

10 REM Bureau de change
20 REM possible solution
30 REM only showing 4 countries
40
50 REPEAT
60   PROCinput
70   PROCprocess
80   PROCoutput
90   PROCspace
100  UNTIL FALSE
110
120 DEF PROCinput
130 CLS
140 INPUT "Which country? "country$
150 INPUT "English Pounds to change? "pds
160 ENDPROC
170
180 DEFPROCoutput
190 PRINT "";pds;" in ";country$;" "
200 PRINT "gives ";
210 IFchangedcash =0 PRINTcurrency$ ELSE PRINT:changedcash;" ";currency$
220 ENDPROC
230
240 DEF PROCspace
250 PRINT "" "Press SPACE to continue. "
260 *FX21.0
270 REPEAT UNTIL GET=32
280 ENDPROC
290
300 DEF PROCprocess
310 currency$="an unknown answer":changedcash=0
320 IF country$ = "AUSTRIA" changedcash = pds * 36:currency$ = "Schillings"
330 IF country$ = "BELGIUM" changedcash = pds * 78.5:currency$ = "Francs"
340 IF country$ = "CANADA" changedcash = pds * 2.75:currency$ = "Dollars"
350 IF country$ = "DENMARK" changedcash = pds * 14.5:currency$ = "Kroner"
360
370 REMetc
380
390 ENDPROC
400

```

XI

Program 2. How you might keep track of cash transactions in a shop

```

10 REM POINT OF SALE TERMINAL
20 REMember that return by itself
30 REM concludes the totalling
40
50 REPEAT
60   PROCinputandadd
70   PROCtotal
80   PROCinputcash
90   PROCcalculatechange
100  PROCshowchange
110  PROCspace
120  UNTIL FALSE
130
140
150 DEF PROCinputandadd
160 total=0:ZX=@X:@X=&20209
170 CLS
180 REPEAT
190   INPUT "Item cost "cost$
200   IF cost$(">")" total=total+VAL(cost$)
210   UNTIL cost$=""
220 ENDPROC
230
240 DEF PROCtotal
250 PRINT "-----"
260 PRINT "Total "total
270 PRINT "-----"
280 ENDPROC
290
300 DEF PROCinputcash
310 REPEAT
320   INPUT "Cash paid "cash
330   UNTIL cash)=total
340 ENDPROC
350
360 DEF PROCcalculatechange
370 change=cash-total
380 ENDPROC
390
400 DEF PROCshowchange
410 PRINT "-----"
420 PRINT "Give "change;" change"
430 PRINT "-----"
440 ZX=ZX
450 ENDPROC
460
470 DEF PROCspace
480 PRINT "" "Press SPACE for next customer"
490 *FX21.0
500 REPEAT UNTIL GET=32
510 ENDPROC
520

```

See 'Problems? No Problem!', page 65

XII

Program 3. Keeping the right time on a 12-hour clock

```

10 REM CLOCK ARITHMETIC
20
30 REPEAT
40   PROCinput
50   PROCprocess
60   PROCoutput
70   PROCspace
80   UNTIL FALSE
90
100 DEFPROCinput
110 CLS
120 INPUT "Enter present time. (Just Hours)? "nowhour
130 INPUT "Enter present time. (Just Mins)? "nowmins
140 INPUT "How many hours will pass? "passhours
150 INPUT "How many minutes will pass? "passmins
160 ENDPROC
170
180 DEF PROCoutput
190 PRINT "The new time will be";newhour;"
    - ";newmins
200 ENDPROC
210
220 DEF PROCspace
230 PRINT "Press SPACE to continue"
240 *FX21,0
250 REPEAT UNTIL GET=32
260 ENDPROC
270
280 DEF PROCprocess
290 newmins = nowmins+passmins
300 carryhour = newmins DIV 60
310 newmins=newmins MOD 60
320 newhour = nowhour + passhours +
    carryhour
330 newhour=newhour MOD 12
340 IF newhour=0 newhour=12
350 ENDPROC
360
370 REM An alternative processing
    procedure:-
380
390 DEF PROCanotherprocess
400 newhour = (((nowmins+passmins)DIV 60) +
    nowhour + passhours) MOD 12
410 IF newhour=0 newhour=12
420 newmins = (nowmins+passmins) MOD 60
430 ENDPROC
440

```

Program 4. A routine to calculate hours worked by staff from clocking on/clocking off records

```

10 REM CLOCKING ON.
20
30 REPEAT
40   PROCinput
50   PROCprocess
60   PROCoutput
70   PROCspace
80   UNTIL FALSE
90
100 DEFPROCinput
110 CLS
120 REPEAT
130   REPEAT
140     INPUT "Enter the clocking on time
        (Just Hours)? "onhour
150     UNTIL onhour)=7 AND onhour <=12
160     INPUT "Enter the clocking on time
        (Just Mins)? "onmins
170     UNTIL onhour+onmins/60)=7.5
180     REPEAT
190       REPEAT
200         INPUT "Enter the clocking off time
            (Just Hours)? "offhour
210         UNTIL offhour<=6 AND offhour>0
220         INPUT "Enter the clocking off time
            (Just Mins)? "offmins
230         UNTIL offhour+offmins/60 <=6
240       ENDPROC
250     ENDPROC
260 DEF PROCoutput
270 PRINT "Time worked today:-
    ";hours;" hours, ";mins;" min/s"
280 ENDPROC
290
300 DEF PROCspace
310 PRINT "Press SPACE to continue"
320 *FX21,0
330 REPEAT UNTIL GET=32
340 ENDPROC
350
360 DEF PROCprocess
370 onhour = onhour+(onmins/60)
380 offhour =offhour +(offmins/60)
390 morning=12-onhour
400 afternoon=offhour
410 hoursworked=morning+afternoon
420 hours=INT(hoursworked)
430 mins=INT((hoursworked-hours)*60)
440 ENDPROC
450
460 DEF PROCanotherprocess
470 hours=INT((12-(onhour+(onmins/60)))
    +(offhour +(offmins/60)))
480 mins=INT((12-(onhour+(onmins/60))+
    (offhour +(offmins/60))-hours)*60)
490 ENDPROC
500

```



A **GSL** COMPUTING PUBLICATION

COMPUTING NEWS

See Us on Stand 14

The 2nd Official Acorn User Exhibition
OLYMPIA
16-19 AUGUST
1984



GSL Winchester Hard Disk System for the BBC Micro NOW INCLUDING REMOVABLE CARTRIDGE DRIVES



GSL staff are working overtime to meet the still increasing demand for their Winchester Systems.

As leading suppliers of Winchester hard disk systems for the BBC micro, GSL has consistently improved both the scope and quality of its products. Since the introduction of the first 20 MByte, 8" Winchester unit at the start of 1983, the range has expanded to include 5.25" drives from 5 to 116 MByte, tape streamers, a comprehensive Winchester Filing System (WFS) and a flexible networking system.

A new addition to this product list is a removable cartridge drive. This is half-height mini-floppy size. The cartridges themselves are less than 4.5" square, and contain 5 MBytes of information. The units are front loading, cartridge replacement being performed in a matter of seconds. Cartridge drives may be used in their own right for stand alone systems, or can be integrated into a system with a large, fixed hard disk for back-up purposes, providing an economical alternative to a tape streamer.

All Winchester systems are fully cased, and self contained, the only connection required, apart from mains, is to the 1MHz bus connector of the BBC micro. The WFS or network (E-Net) firmware is supplied on

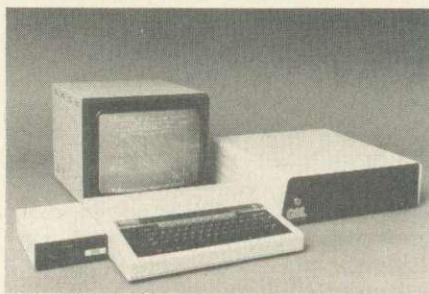

The New Streamlined Winchester System.



Winchester Disc Drives are put through a 24 hour intensive test programme prior to despatch to customers around the world.

Eprom. Fully rack mounted systems may also be provided, and other facilities available include a real time clock, and a link board for connecting two micros to one Winchester system.

	Price £
5 MB Winchester System	1650.00
10 MB Winchester System	1950.00
20 MB Winchester System	2600.00
30 MB Winchester System	2900.00
40 MB Winchester System	3630.00
65 MB Winchester System	4700.00
105 MB Winchester System	5130.00
140 MB Winchester System	7000.00

New Winchester Backup Facilities

Backup of the E-Net fileserver Winchester has up to now been limited to selective transfer of user areas to floppy disk. In order to augment this, the following facilities are now (or shortly will be) available.

- (a) Backup of user attributes to floppy disk. (Available on application)
- (b) Full backup of the fileserver drive to a second (similar) Winchester unit. (This should be available within few weeks)
- (c) Full backup to removable cartridge drives. At present only 5 MByte units have been evaluated, necessitating the use of two cartridges for backup of a 10 MByte Winchester. (Expected availability is 1 to 2 months)
- (d) Full backup to tape streamer (20 or 45 MBytes). (Expected availability is 2 months).

Existing single Winchester systems can be upgraded to contain backup units for any of options (b), (c) and (d), additional hardware being accommodated within the current casing. At present the most cost effective solution for pure backup purposes is likely to be option (b), with (d) the most costly, though in the latter case some improvement is hoped for before the end of the year. Prices are available on application.

We are an official Acorn Dealer and Service Centre
Dealer Enquiries Welcome

Return to **GSL COMPUTING**, West Portway Industrial Estate,

I am interested in the following:
(please tick)

- The GSL Winchester System
- 5 MB
- 10 MB
- 20 up to 200 MB
- The GSL Slim Line Disc Drives
- Your full range of Micro Computers and computer peripherals
- GSL Analogue Signal Display and Analysis System
- GSL Printer Buffer

Andover, Hampshire
SP10 3SG

Name: _____
 Position: _____
 Company: _____
 Address: _____
 Phone: _____
 Send me by return full technical information

Or phone Lee Wyatt on Andover (0264) 59633

£20

◀ page 97

Mode 0 dumps in under five minutes

Mr Miller explains...

The advantage of setting the screen to green characters is that only one gun of the monitor is on, which gives a very crisp display, as well as being quite restful.

Method: create two files (using VIEW), called \$.!BOOT and \$.!BOOT2 as in listing 3.

Notes:

1. To use, do a SHIFT/BREAK.
2. It is assumed that the computer initialises to mode 3.
3. *TV255, 1 moves the display down one line so that the first line is visible, and stops flicker by turning off the interlace. MODE 3 does the obvious, and actions the *TV command.
4. *FX155,nnn perform the mode 3 equivalent of VDU19, 1, 2, 0, 0, 0. VDU instructions will not work from within View.
5. Normally, Break would reset the computer to 'standard', so redefining the key allows easy recovery of colour, auto repeat, the vital OLD, as well as a useful *FX125 (escape) into text mode.

... Mr Miller would like to know how to redefine the cursor colour. Can anyone help?

```
*! $.!BOOT BBC=WP
*WORD
*TV255, 1
MODE 3
*KEY10 *EXEC $.!BOOT2!M
NEW
```

```
*! $.!BOOT2 set grn,
      auto rpt spd,
      OLD, escape
*FX155, 130
*FX155, 146
*FX155, 162
*FX155, 178
*FX155, 194
*FX155, 210
*FX155, 226
*FX155, 242
*FX12, 4
OLD
*FX125
```

Listing 3. James Miller's basis of a !BOOT file for setting up a green screen with View

SOME excellent mode 0 screen dumps have been sent in by Bernard Beeston of Enfield. What is so surprising is that they were produced using a single line of program (listing 4) and it will work on an Epson, Star and Shinwa CP80 printer.

In Mr Beeston's words...

This was written as a GOSUB but it could just as well be a PROC or GOTO, or just a line in the main program.

The MOVE0, 0 at the beginning overcomes the POINT bug in the 0.1 OS.

Within the last few weeks I have written an even better mode 0 dump, which although still in Basic takes only about

4½ minutes – yet it almost fills an A4 sheet. I calculate that the printer runs at the rate of about 1900 printer pixels per second and as the printer is busy almost all the time I doubt if a machine code routine would speed things up much.

Here is the new program (listing 5), which this time has to be in two lines. As with listing 4 I have given it nominal line numbers.

One snag with this routine is that the screen must not be allowed to scroll as the screen memory is read directly. I enclose a few samples from both programs.

```
900 MOVE0,0:VDU29,0;0;2,1,27,1,51,1,24
,1,13:FOR%Y%=1023TO0STEP-32:VDU1,27,1,76,
1,22,1,2:FOR%W%=0TO6401STEP12:X%=W%/5:A%=
0:FOR%Z%=2TO30STEP4:A%=A%*2+POINT(X%,Y%-Z
%):NEXT:VDU1,A%:NEXT:VDU1,10,1,13:NEXT:V
DU1,27,1,64,3:RETURN
```

Listing 4. One-liner from Bernard Beeston that produces good mode 0 screen dumps from various printers. It takes about seven minutes

```
900 VDU2,1,27,1,51,1,24,1,13:A%=32135:
REPEAT:VDU1,27,1,76,1,64,1,3:FOR%B%=A%TOA
%-19840STEP-640:FOR%C%=B%TOB%-7STEP-1:VDU
1,?C%,1,?C%,1,?C%:IFC% MOD 4=0VDU1,?C%
910 NEXT,,:VDU1,10,1,13:A%=A%+8:UNTIL A%
>32767:VDU1,27,1,64,3:RETURN
```

Listing 5. Two-liner from Mr Beeston that executes dumps in less than five minutes

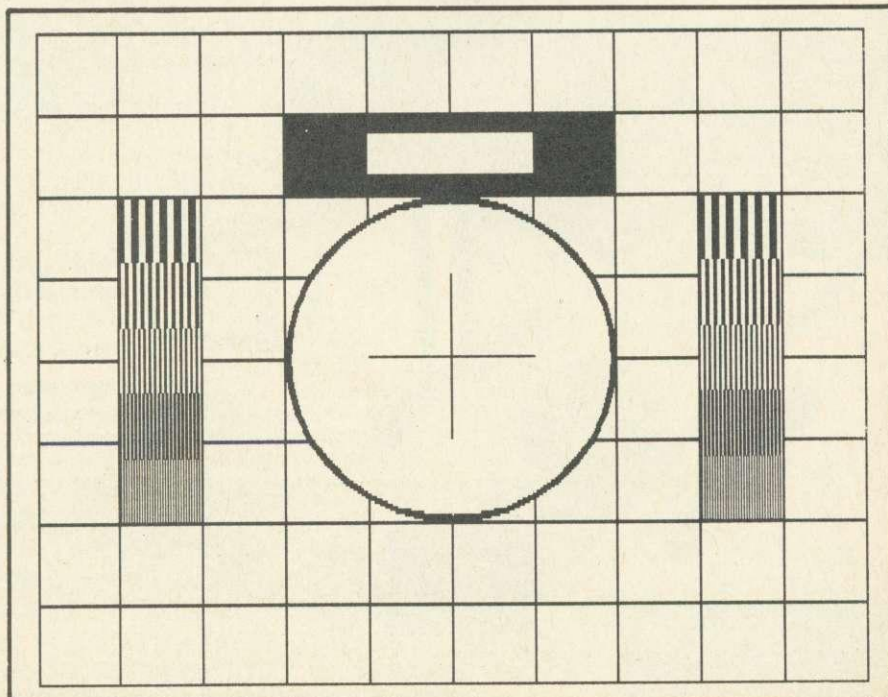

Just testing... Sample dump produced by Bernard Beeston's one-line routine

£10

Teletext editing

A USEFUL machine code program that enables teletext characters to be edited on the screen comes from Jon Warmisham. Jon writes...

The routine (listing 6) is called with CALL&1800 (or whatever P% is set to) and makes only the keys Q,W,A,S,X,Z and the cursor keys active. The letter keys correspond to the six character cells of a mode 7 graphic character and when the cursor is positioned under a character, each cell can be turned off and on independently. Pressing Escape returns command to Basic and normal editing can continue.

If a program line is edited in this way it must be copied with the copy key as the edited image is only a 'screen image'. The routine saves the time and trouble of looking up each corresponding character code while typing in strings. I use the upper ASCII code table to enable the full set of graphics shapes.

Together with the function-key set up published in the May edition, this routine gives a full teletext editor available in command mode.

```

10 REM Routine for editing mode 7
20 REM graphics in command mode.
30 REM Use CALL&1800 to activate.
40 REM Press ESC to return to BASIC.
50 REM Jon Warmisham (c) 1984
60 REM Keys : Q W
70 REM A S
80 REM Z X
90 REM Correspond with the 6 pixels
100 REM of a Mode 7 graphic character.
110 MODE 7
120 temp=%70
130 FORPASS=0T03 STEP1
140 PZ=&1800
150 LDPT PASS
160 .loop LDAE&4 \ *FX 4,1 Cursor keys
170 LDXE1 \ now return codes
180 JSR&FFF4 \ &BB to &BB
190 LDAE&F \ flush keyboard
200 LDXE1 \ buffer
210 JSR&FFF4 \ via osbyte
220 LDAE0 \ load Acc. and Y
230 TAX \ registers with 0
240 JSR&FFE0 \ osrdch routine
250 CMPE&1B \ is it <ESC> ?
260 RNE over
270 LDAE&7E \ acknowledge <ESC>
280 JSR&FFF4 \ via osbyte and
290 LDAE&34 \ reinstate cursor
300 LDXE0 \ editing for a clean
310 JSR&FFF4 \ return to BASIC
320 RTS
330 .over CMPE&51 \ is key 'D'?
340 BEQ q \ yes. jump to q
350 CMPE&57 \ is key 'W'?
360 BEQ w \ yes. jump to w
370 CMPE&41 \ is key 'A'?
380 BEQ a \ yes. jump to a
390 CMPE&53 \ is key 'S'?
400 BEQ s \ yes. jump to s
410 CMPE&5A \ is key 'Z'?
420 BEQ z \ yes. jump to z
430 CMPE&5B \ is key 'X'?
440 BEQ x \ yes. jump to x
450 CMPE&8B \ is key 'left cursor'?
460 BEQ left \ yes. jump to left
470 CMPE&89 \ is key 'right cursor'?
480 BEQ right \ yes. jump to right
490 CMPE&8A \ is key 'down cursor'?
500 BEQ down \ yes. jump to down
510 CMPE&8B \ is key 'up cursor'?
520 BEQ up \ yes. jump to up
530 RNE loop \ no? back to loop
540 .down LDAE10 \ vdu 10
550 JSR&FFEE \ move cursor.
560 JSR loop
570 RTS
580 .q LDAE&1 \ store value in
590 STA temp \ zero page
600 JSR read \ jump to read...
610 JSR loop \ back to loop.
620 RTS
630 .w LDAE&2 \ store value in
640 STA temp \ zero page
650 JSR read \ jump to read...
660 JSR loop \ back to loop.
670 RTS
680 .a LDAE&4 \ store value in
690 STA temp \ zero page
700 JSR read \ jump to read...
710 JSR loop \ back to loop.
720 RTS
730 .s LDAE&8 \ store value in
740 STA temp \ zero page
750 JSR read \ jump to read...
760 JSR loop \ back to loop.
770 RTS
780 .z LDAE&10 \ store value in
790 STA temp \ zero page
800 JSR read \ jump to read...
810 JSR loop \ back to loop.
820 RTS
830 .x LDAE&40 \ store value in
840 STA temp \ zero page
850 JSR read \ jump to read...
860 JSR loop \ back to loop.
870 RTS
880 .read LDXE0 \ empty X register
890 LDAE&B7 \ read character at
900 JSR&FFF4 \ cursor and transfer
910 TXA \ to Accumulator
920 EOR temp \ exclusive-or with temp
930 ORAE&80 \ adjust to higher
ASCII table
940 JSR&FFEE \ send to screen
950 LDAE&F \ back space to
960 JSR&FFEE \ original position
970 RTS
980 .left LDAE&B \ vdu 8
990 JSR&FFEE \ move cursor.
1000 JSR loop \ back to loop.
1010 RTS
1020 .right LDAE9 \ vdu 9
1030 JSR&FFEE \ move cursor.
1040 JSR loop \ back to loop.
1050 RTS
1060 .up LDAE11 \ vdu 11
1070 JSR&FFEE \ move cursor.
1080 JSR loop \ back to loop.
1090 RTS
1100 J
1110 NEXT PASS
1120 END
    
```

Listing 6. Jon Warmisham's teletext character editing program

LET YOUR BBC SYSTEM GROW ON A ZYGON STAND



ZYGON. The purpose-designed stand for the BBC Micro. The BBC system is designed to expand. The Zygon range grows with it.

ZYGON DELTA. The top-of-the-range Zygon Delta provides lots of space for a total, comprehensive computer system. Space not only for your BBC Micro and monitor but also for your disc drives, printer, interfaces and modems, as well as for a second processor. The lower computer shelf slides away for full keyboard protection and, on castors, can easily be moved from room to room.

- Upper shelf measures 1270 x 480mm.
- Lower shelves measure 1270 x 550mm.

To: Zygon Products, FREEPOST, 9 Sheredes Drive, Hoddesdon, Herts, EN11 8BR
Please send me (No stamp required)

.....ZYGON DELTA Stands at £118.45 (incl. p&p and VAT)

.....Brochure of the complete Zygon range. I enclose cheque for £..... payable to Zygon Products.

Name:.....

Address:.....

..... Postcode.....

Allow 28 days for delivery. Full refund if goods returned undamaged within 14 days.

Telephone: Hoddesdon (0992) 466259.



SEE US AT
The 2nd Official
Acom User
Exhibition
OLYMPIA
16-19 AUGUST
1984

ON
STAND
50

THE EXPERTS

EXPORT

SCI(UK) SETTING NEW STANDARDS

IN CUSTOMER SERVICE

0730 68521 ANY DAY INCLUDING SUNDAY



ORDER TODAY -
PRINT TOMORROW!
24 HOUR DELIVERY

ORDER TODAY -
PRINT TOMORROW!
24 HOUR DELIVERY



EPSON LOW PRICE SPECIALS FROM £199

7 DAYS
A WEEK

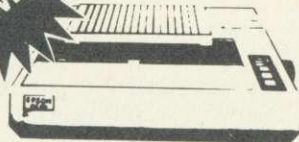

EPSON RX80 (DOT MATRIX)	£249	£199	+ VAT = £228.85
EPSON RX80FT (DOT MATRIX)	£285	£239	+ VAT = £274.85
EPSON FX80 (DOT MATRIX)	£438	£324	+ VAT = £372.60
EPSON MX100 (DOT MATRIX)	£475	£365	+ VAT = £419.75
EPSON RX100 (DOT MATRIX)	£450	£385	+ VAT = £442.75
EPSON FX100 (DOT MATRIX)	£569	£499	+ VAT = £573.85

NEW! Canon PW-1080A £269.00

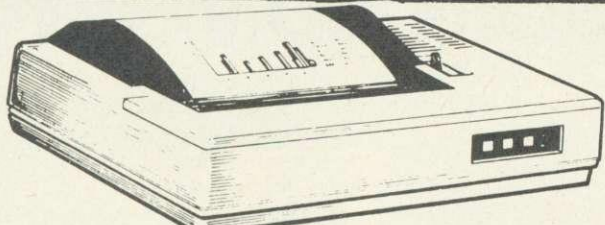

+ VAT = £309.35

80 cols; High speed printing, 160 CPS; bi-directional logic seeking; fantastic 27 CPS near letter quality; 23 x 18 matrix; very quiet - less than 60 dB; 4, 5, 6, 8 10, 12, 17 CPI; down loading for user-optional characters; high resolution graphics; handles various forms, roll paper, fan fold, single sheet and multipart copy paper.

ALSO AVAILABLE THE CANON PW1156A as above but 156 cols **£369.00** + VAT = £424.35

PHONE 0730 68521 INCLUDING SUNDAY!

JUKI 6100 just **£349** + VAT = £401.35

SHINWA CP80 **£179.00** + VAT = £205.58

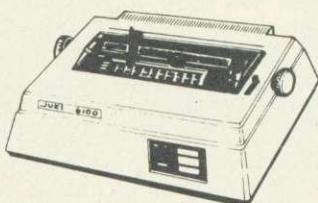

20CPS: Bidirectional & Logic 10, 12, 15 & Proportional Spacing; Wordstar compatible 2K Buffer; 13 inch Platen Underline; backspace & lots more Centronics Interface Standard

OPTIONAL RS232 TRACTOR AND SHEET FEEDER

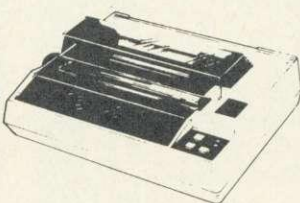

Friction and tractor feed as standard. 80cps. Bi-directional logic seeking 13 x 9 dot matrix giving true descenders, sub and superscripts Italic printing and auto underlining Condensed, emphasised, expanded and double strike (can be mixed in a line). Parallel interface fitted as standard

WE WILL MATCH ANY GENUINE PRICE ADVERTISED SCI(UK) IS NEVER BEATEN ON PRICE

MANY MORE PRINTERS AVAILABLE 1,000s OF BARGAINS SEND NOW FOR THE FAMOUS SCI(UK) CATALOGUE



FIDELITY 14" COLOUR MONITOR & COMPOSITE VIDEO

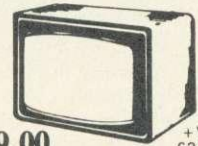

£189.00 + VAT = £217.35

We have interfaces and cables for all types of computers, including CMB 64, Vic 20, APPLE, TRS 80, IBM, BBC, SPECTRUM, DRAGON, TANDY, SINCLAIR, APRICOT, SIRIUS, MONOTECH, QL, ADVANCE, TEXAS ETC



24 hour nationwide delivery by Securicor £9.50 + vat. Bankers Orders; Building Society Cheques; Postal Orders; - same day despatch. All orders covered by the Mail Order Protection Scheme. Nationwide maintenance contracts arranged. Educational discounts very welcome.

SCI(UK)
0730 68521

FREEPOST
PETERSFIELD
HANTS GU32 2BR
TELEX 86626 MYNEWS G

DEALER ENQUIRIES
WELCOME WRITE
FOR DETAILS

TRADE

CALLERS WELCOME SEVEN DAYS A WEEK TO OUR SHOWROOM AT 12 HIGH ST., PETERSFIELD, HANTS

URGENT ORDER
PLEASE RUSH ME
Name _____
Address _____
Credit Card _____
Number _____
SCI(UK) FREE POST
PETERSFIELD, HANTS GU32 2BR



Paul Beverley

Paul Beverley and Nigel Eames, in quest of a better random number generator, offer three alternatives: one software and two hardware

106

LAST month, in this series of articles about how the BBC micro works, we looked at the random number generator (RNG), which is implemented in Basic. Having established that random numbers are generated by using a software algorithm, we looked at ways of speeding this process up, first by accessing the machine code programs directly rather than through the RND function, and secondly by writing a simpler and faster algorithm.

This month we look at three ways of speeding things up even more. There is an even better software generator and then two hardware generators that can be connected to the computer via the user port. The first hardware generator (figure 1) uses a purely digital circuit and is in fact a hardware version of the algorithm used in the Basic interpreter – ie, a shift register with exclusive-OR feedback. The second (figure 2) is a 'true' random number generator as opposed 'pseudo-random'. It uses the analogue technique of amplifying the random noise generated by an electronic component.

'The random number generator algorithm in Hi-Basic is much faster than the one in Basics I and II'

Software RNG

The random number generator algorithm in Hi-Basic (as used on second processors) is much faster than the one in Basics I and II. To be precise, the subroutine in Basic I and II that generates each four-byte (32-bit) random number takes 714 microseconds, whereas the equivalent subroutine in Hi-Basic, even when run on the standard machine, takes only 156 microseconds – a considerable saving.

In the original subroutine, a 33-bit

HIGH-SPEED RANDOM NUMBERS

number was shifted 32 times, one bit at a time, to produce the new number. To improve the speed, Hi-Basic shifts the 33-bit number one *byte* at a time and therefore makes only four shifts. Although the routine itself is longer, since it is done only four times it is a lot faster. This new routine is shown in program 1. This program uses the routine with only a single byte-shift to show how to produce single-byte random numbers, but for a four-byte number you would CALL or JSR the routine starting from "newRND" (line 40) – ie, entering the 'next byte' routine (line 70) with the Y-register containing 4 – and then pull out the resulting number from locations &0D to &10. If you are using Basic then you would use !&0D.

Digital RNG

The digital random number generator consists of two eight-bit shift registers in series (2 x 74LS164), with exclusive-OR gates applying feedback to the data input, forming what is known as a ring-counter or chain-code generator. The number produced by this ring-counter is read into the 6522 VIA shift register through the CB2 line, while the CB1 line provides clock pulses to do the shifting. When the register is not being read, it is continuously shifted by a 5MHz clock consisting of a simple Schmitt trigger astable circuit. The PB7 line from the VIA is used to disable this oscillator while the shift register is being read by the VIA.

If the PB0 line, which is also exclusive-ORed in with the feedback, is kept at a constant logic level then the shift register will go through a fixed cycle of ($2^{16}-1$) states (65535). This does not seem to compare very favourably with the software RNG implemented in Basic, which uses a 33-bit shift register, but there are two ways in which the randomness is improved. First, the 5MHz

clock is exercising the ring counter all the time, except when it is being read, unlike the Basic RNG, which is shifted only when a new number is called for. Thus the numbers returned by the hardware RNG will depend on how long it is since the register was last accessed. Also, the clock is free-running which means that the way it shifts the ring counter is totally independent of the operation of the processor.

The second added randomness is that the PB0 line, which is also exclusive-ORed into the feedback line, is inverted every time an IRQ interrupt occurs. This means that at least every 10 milliseconds – usually more often – the data chain of the ring counter is altered. Again, as with the 5MHz clock, this event is independent of the timing of the main program.

Analogue RNG

As with the digital RNG, the number is read into the computer by using the VIA shift register. The data is latched from a bistable, which itself is clocked by digital noise generated by amplifying the noise from a zener diode noise source. The reason for using the bistable is that the raw data, amplified from the zener, may not spend equal times high and low which, if read directly, would therefore produce bias towards those numbers with more bits at logic 1 or more bits at logic 0.

The analogue part of the circuit consists of a high-gain, high-bandwidth amplifier, driving a transistor switch. This clocks a negative edge triggered bistable so that the bistable output is dependent on the random frequency

Please turn to yellow pages i and ii for the two listings referred to in this article

ANSWER BACK SENIOR QUIZ GENERAL KNOWLEDGE

THE ULTIMATE EDUCATIONAL QUIZ
FOR AGES 12 & OVER

BBC (32K)•ELECTRON

The ANSWER BACK Quiz provides an incredible adventure in education by combining a compelling Space-Age game with an immense series of questions on General Knowledge. The thought-provoking and well-researched quizzes contain an enormous total of 750 questions with 3000 answer options covering the following subjects:

- Astronomy Music Natural History Famous People Science Sport
- History Art and Architecture Know your Language Discoveries and Inventions
- Legends and Mythology Geography Literature
- Films, TV and Theatre Pot Luck

The highly sophisticated control program rewards each correct answer with another turn in the colourful, animated game.

FEATURES INCLUDE

- Multiple choice answers True or False? Find the missing letters
- "Pass" facility Immediate correction of errors Timer option
- Performance summary Re-run of questions passed or incorrectly answered
- Full facilities for creating and saving an unlimited number of new quizzes

Available from your computer store or by mail order Price £10.95.

NOW AVAILABLE
ANSWER BACK
Junior Quiz
for the under 11's



Other educational titles include...
"The French Mistress"
"The German Master"
"The Spanish Tutor"



KOSMOS software, 1 Pilgrims Close, Harlington, DUNSTABLE, Beds LU6 6LX
Telephone (05255) 3942

The ANSWER BACK Senior Quiz will educate and fascinate ANYONE over 11 years old.

KOSMOS SOFTWARE, 1 Pilgrims Close, Huntington, DUNSTABLE, Beds LU6 6LX
Please send me the ANSWER BACK Senior/Junior Quiz for the BBC/ELECTRON computer

Mr/Mrs/Miss.....

Address.....

.....

..... Post code.....

I enclose a cheque/postal order for £10.95 payable to KOSMOS Software

NEW! Canon PW-1080A

We'll help you look good on paper

80 cols; High speed printing, 160 CPS; bi-directional logic seeking; fantastic 27 CPS near letter quality; 23 x 18 matrix; very quiet - less than 60 dB; 4, 5, 6, 8, 10, 12, 17 CPI; down loading for user-optional characters; high resolution graphics; handles various forms, roll paper, fan fold, single sheet and multipart copy paper.

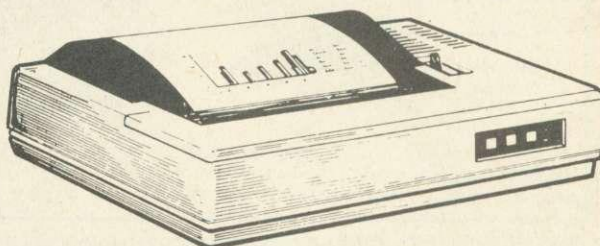

Fantastic Value

£269.00 + VAT =
£309.35

Phone 0730 68521 - 9 to 6 seven days a week!

Canon PW1156A £369.00 + VAT = £424.35

All the features of the PW1080A detailed above but 156 cols!

NOW YOU CAN PRINT IN COLOUR FOR JUST £399 + VAT = £457.85

Canon PJ 1080A £399.00 + VAT = £458.85

Seven colour printer ideal for the BBC, Sirius, Apple, etc. Seven colours print on demand ink jet printer; 70 CPS bi-directional; high resolution graphics; will print on acetate sheets for overhead projection; long life ink cartridges 3.5 million characters per cartridge; eight bit parallel interface; Epson compatible; easily replaced colour cartridges; accepts single sheets; interchangeable character sets.

Just unbelievable value at £399.00 + VAT =
£458.85



24 hour nationwide delivery by Securicor £9.50 + vat. Bankers Orders; Building Society

Cheques; Postal Orders; - same day despatch. All orders covered by the Mail Order Protection Scheme.

SCI(UK) FREEPOST PETERSFIELD HANTS GU32 2BR 0730 68521 TELEX 86626 MYNEWS G

PERSONAL CALLERS WELCOME AT OUR
MAGNIFICENT NEW SHOWROOMS AT
12 HIGH ST., PETERSFIELD, HANTS

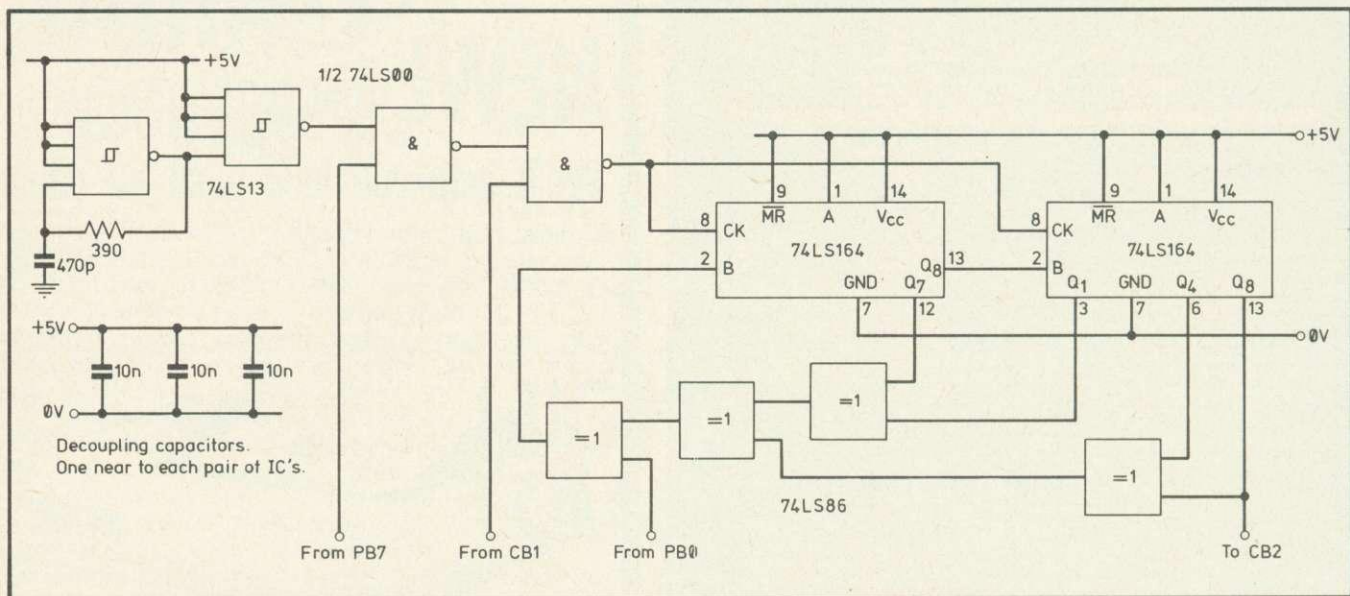

Figure 1. Circuit diagram of the digital random number generator

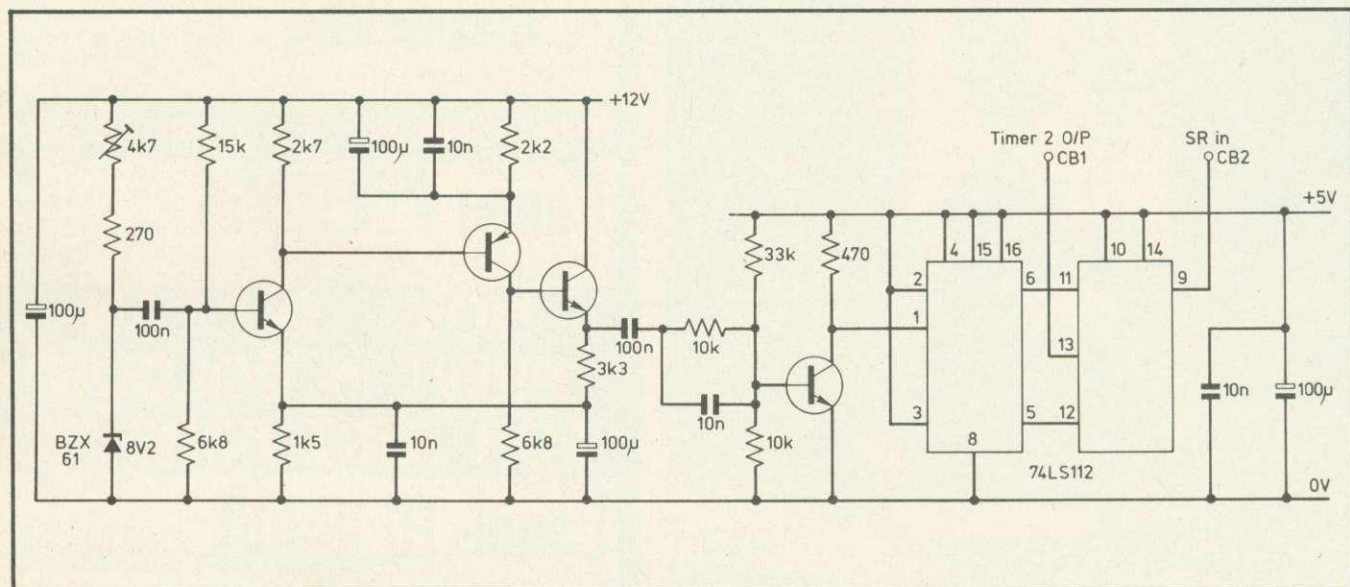

Figure 2. Circuit diagram of the analogue random number generator

changes rather than the amplitude changes of the noise source. The outputs of the first bistable are fed into the J and K inputs of the second bistable, which latches the data on the negative going edge of the CB1 output.

Software for the hardware

Program 2 shows the control software for the two hardware RNGs, plus tests to check their randomness. These are the two tests that we used last month for checking the software RNGs. The subroutines necessary for the digital RNG are in lines 820 to 1300, and those for the analogue RNG in lines 1340 to 1560.

The test routines occupy lines 1720 to 2210.

Clearly this program as a whole shows all the routines needed to test both RNGs, which in practice you will

not want to do, but it should be easy enough once you have decided which generator to use to type in only the lines you need. You will need to use this program if you make a generator, as it will show you whether or not the hardware is working correctly. This is especially important in the case of the analogue RNG because the maximum speed at which you can read it is determined by the bandwidth of the amplifier, and that will depend finally on the transistors used and even the layout of the components on the printed circuit board.

When the tests are run, you will find that the histogram shows a degree of 'drooping' at each end if you are trying to read it too fast. That is to say that numbers with lots of zeros or lots of ones occur less often than average. The prototype needed a delay of six to

ensure that there was no visible bias on the histogram test.

Which RNG?

If you need to produce random numbers more quickly than the Basic random number generator is capable of, which of the three suggested here would be most suitable?

In terms of speed, the digital RNG is the fastest at 20 microseconds per eight-bit number; the new software RNG is next at 44 microseconds; and the analogue slowest at 128 microseconds. One point to note, though, is that with the two hardware generators, the time quoted is the maximum time between readings rather than the length of time taken to do the reading. In other words, during the time that the VIA is busy shifting in the new value, the processor can be doing some cal-

A J SOFTWARE for BBC



'The Record Changer'

32K £19.95 Cass. £24.95 Disc.

for indexing, membership lists, directories, inventories, budgeting, etc, etc.

don't buy a database in the dark —
check the spec!

'The Wordsmith' 32K for Centronics 737/739

AND NOW FOR EPSON FX80:

£19.95 Cass. £24.95 Disc.

Options Timetable 32K

£14.95 Cass. £19.95 Disc.

Simple Word Processor 32K

£9.95 Cass. £14.95 Disc.

Picture Maths

£9.95 Cass. £12.95 Disc.

An arithmetic practice program for primary schools.

Character Definer £9.95 Cass.

Enlarge, reduce, etc, etc.

Tape Catalogue £5.95 Cass.

Catalogue all your tapes using this program and never lose one again

Copy Disc £9.95

Copy disc to tape, tape to disc, M/C, Data or Basic.

ROM Read

£8.95 Cass. £11.95 Disc.

A machine code program to read the contents of any ROM socket and copy to RAM, tape or disc. Not to be used for illegal copying.

Machine code Disassembler

£5.95 Cass. £7.95 Disc.

Open Evening Timetable 32K

£14.95 Cass. £19.95 Disc.

Utility Eprom £19.95

for basic programmers

Mitsubishi Disc Drives

Dual 80 Track 800K £380 + VAT

Single Track Drives

Dual Sided 200K £199 + VAT

Double Density Disc Interface £80 + VAT

The best there is.

Epson Printers

FX80 £370 + VAT

RX80 £270 + VAT £8.00 Carr

BBC Epson Cable £15 + VAT

Normende

Not only the cheapest, but the best

Switchable 14" RGB Monitor/Colour TV £250 inc. VAT and cable, £8.00 carr.

Royalties for quality software

All prices VAT inclusive except where shown

AJ Vision Service Ltd, 61 Jeddo Road

London W12 9ED

NEW! The Complete Printer Interface for the Commodore 64

The Grappler gives you the print out you need from Epson, Star, Oki, Brother, Prowriter and other popular printers. Graphics screen dumps including inversed, double-sized, rotated/enhanced graphics with special features
for Epson FX and RX printers.

£102.00 + VAT =
£117.30

DAISY STEP 2000

£249.00 + VAT =
£286.35

7 DAYS
A WEEK

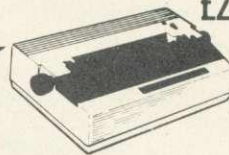

18cps; Bi-directional logic seeking; 10, 12, 15cps; Wordstar compatible; 13 inch platen; 12 inch print line; auto underscore; bold and shadow printing; subscripts and superscripts; Qume compatible daisy ribbons; Qume compatible daisy wheel; optional tractor and sheet feeder; optional RS 232C; serial interface; low noise; low cost; high reliability.

Don't accept anything less

WHEELS ★ CABLES ★ INTERFACES ★ PAPER ★

TABLES ★ DAISY WHEELS ★ CABLES ★

INTERFACES ★ PAPER ★ TABLES ★ DAISY

WHEELS ★ CABLES ★ INTERFACES ★ PAPER ★

TABLES ★ DAISY

INTERFACES

WHEELS ★ CABLES ★ INTERFACES ★ PAPER ★

TABLES ★ DAISY WHEELS ★ CABLES ★

INTERFACES ★ PAPER ★ TABLES ★ DAISY

WHEELS ★ CABLES ★ INTERFACES ★ PAPER ★

TABLES ★ DAISY WHEELS ★ CABLES ★

INTERFACES ★ PAPER ★ TABLES ★ DAISY

WHEELS ★ CABLES ★ INTERFACES ★ PAPER ★

TABLES ★ DAISY WHEELS ★ CABLES ★

INTERFACES ★ PAPER ★ TABLES ★ DAISY

WHEELS ★ CABLES ★ INTERFACES ★ PAPER ★

TABLES ★ DAISY WHEELS ★ CABLES ★

INTERFACES ★ PAPER ★ TABLES ★ DAISY

WHEELS ★ CABLES ★ INTERFACES ★ PAPER ★

TABLES ★ DAISY WHEELS ★ CABLES ★

INTERFACES ★ PAPER ★ TABLES ★ DAISY

WHEELS ★ CABLES ★ INTERFACES ★ PAPER ★

TABLES ★ DAISY WHEELS ★ CABLES ★

INTERFACES ★ PAPER ★ TABLES ★ DAISY

WHEELS ★ CABLES ★ INTERFACES ★ PAPER ★

TABLES ★ DAISY WHEELS ★ CABLES ★

INTERFACES ★ PAPER ★ TABLES ★ DAISY

WHEELS ★ CABLES ★ INTERFACES ★ PAPER ★

TABLES ★ DAISY WHEELS ★ CABLES ★

INTERFACES ★ PAPER ★ TABLES ★ DAISY

WHEELS ★ CABLES ★ INTERFACES ★ PAPER ★

TABLES ★ DAISY WHEELS ★ CABLES ★

INTERFACES ★ PAPER ★ TABLES ★ DAISY

WHEELS ★ CABLES ★ INTERFACES ★ PAPER ★

TABLES ★ DAISY WHEELS ★ CABLES ★

INTERFACES ★ PAPER ★ TABLES ★ DAISY

WHEELS ★ CABLES ★ INTERFACES ★ PAPER ★

TABLES ★ DAISY WHEELS ★ CABLES ★

INTERFACES ★ PAPER ★ TABLES ★ DAISY

WHEELS ★ CABLES ★ INTERFACES ★ PAPER ★

TABLES ★ DAISY WHEELS ★ CABLES ★

ADMATE DP-80

£169.00 + VAT =
£194.50

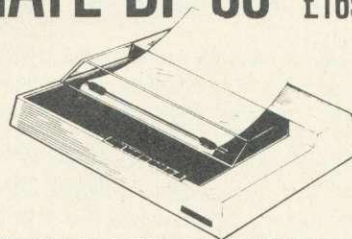

The Admate DP-80 has a large range of features and a low price. Ideal for the first time user. 80 CPS; 80 column; Bi-directional logic seeking; block and dot addressable graphics; sub/superscript, auto underline, condensed, emphasised, expanded and italic print.



24 hour nationwide delivery by
Securicor £9.50 + vat. Bankers
Orders; Building Society

Cheques; Postal Orders; - same day despatch. All orders covered by
the Mail Order Protection Scheme.

SCI(UK)
0730 68521

**FREEPOST
PETERSFIELD
HANTS GU32 2BR**
TELEX 86626 MYNEWS G

**PERSONAL CALLERS WELCOME AT OUR
MAGNIFICENT NEW SHOWROOMS AT
12 HIGH ST., PETERSFIELD, HANTS**

culations with the previously generated number.

The minimum time needed to read the digital RNG is five microseconds, assuming that the X register is available with zero in it to put into the high byte of Timer 1, and that you do not bother checking whether the timer 1 flag is set. If you do this, you must be sure that the time taken to process each number is greater than 15 microseconds. If you try to read the number too soon then you will get an incorrect reading and the randomness will be reduced.

To read the analogue RNG, again assuming that you do not try to read it too soon, takes only 2.5 microseconds – the time of an LDA & FE6A.

Clearly the software generator is the easiest to implement since no hardware needs to be made available. This would be a considerable advantage if, for example, you wanted a class of students to run the same simulation on

each of say 10 microcomputers. Also, this generator can be used on the Electron directly, whereas for the hardware RNGs you'd need to add a 6522 VIA interface (as explained in *Acorn User*, December 1983). Remember though that the timings on the Electron will be different as the RAM works at half the speed of the ROM.

Which of the two hardware generators you think is simpler to construct depends on whether you prefer to make up digital circuits or analogue circuits. In terms of software though, as you can see from program 2, the digital generator needs more instructions – an interrupt routine needs setting up, and you need to control Timer 1 instead of it working entirely automatically on Timer 2, as with the analogue generator. Also the digital generator uses two extra control lines – PB0 and PB7.

It would be helpful to know which one gives the 'best' random numbers. Unfortunately the two tests we have used

can only show whether there are any obvious defects. In theory though, since the analogue generator is based on a truly random process, it should be the best. Whether it is or not, and which of the other two generators is the better, we cannot as yet say, since we know of no more rigorous tests. We issued a plea last month for any tame statisticians who know how we could test our generators to contact us via the editor, but so far we've had no response. When we do, we'll publish the results for all the generators that we've looked at in both articles.

Next month: If you have made up the digital random number generator you'll be well on the way to having a system that can be used to 'exercise' different parts of your computer. You'll be able to find out if there are any faults in the computer's hardware, and go some way towards locating them through a process known as 'signature analysis'.

ARIES UPGRADE FOR WORDWISE

Jacquetta Megarry finds the advantages . . . and snags

Wordwise-Aries wordprocessing ROM, BBC, Computer Concepts, £46 inc (or £10 in exchange for Wordwise ROM)

A NEW version of the Wordwise wordprocessing ROM for the BBC micro is now available. The upgrade costs £10 if you return your existing chip to Computer Concepts; new customers can get the latest version from dealers at the same price as the old.

Called the Wordwise-Aries, the upgrade – now being sold as the standard Wordwise ROM – has been designed to capitalise on the Aries RAM expansion board from Cambridge Computer Consultants. With the Aries B20 board fitted, Wordwise users can preview the format of long documents at 80 characters per line. In the previous standard set-up, this was only possible up to around 1,500 words; longer documents have to be previewed at 40 characters per line, making format difficult to check. The overall word limit (about 4,500 words) for a Wordwise text file remains the same.

Users without the Aries board may still prefer the new Wordwise, as it incorporates worthwhile extra features without any vices of incompatibility. Pauses can be forced during preview or printing instantaneously by pressing the space bar, or in advance by inserting an embedded command into the text. This is useful to arrest unwanted

scrolling or to permit a change of daisy-wheel.

A powerful new feature allows commands to be passed to the BBC's operating system from *within* the text. For example, the embedded command OS"CAT" would cause a catalogue of all the files held on disc to be printed as part of the document. Using the OS command to access other ROMs or files, you can make spreadsheets, screen dumps of graphics and fancy lettering an integral part of documents printed out under Wordwise.

Other features of the Wordwise-Aries include the ability to switch between or suppress printers at the output stage and the option to print multiple copies automatically using a machine code routine.

What are the snags with the new arrangement? The main benefits will only be felt if you buy the Aries board, which means spending another £99.95. However, this gives you 20k of extra RAM for Basic programs too (making 51k addressable in mode 7). It will not fit if you already have a sideways ROM board – essential for combining Wordwise with other firmware like the Graphics ROM, the new Printmaster, Microtext and spreadsheet or database chips. However, Cambridge Computer Consultants has brought out a compatible board (the B12) at £46 which

accepts 12 ROMs. The B20 and B12 can both be fitted at once and together they represent a major upgrade to an already powerful machine. This is an option which should be considered by anyone who regularly uses Wordwise on long documents or who finds the 32k RAM limit restrictive.

What I greatly regret is that the opportunity was not taken to correct Wordwise's unfriendliest feature: the system will accept an instruction to save to a filename already in use without asking if the user really means it. So if you hit Save by mistake instead of Load (easily done as they are adjacent on the menu) you can overwrite a live file with an empty memory. Designer Charles Moir is aware of this problem and considered trapping it. Alas, the Aries modifications left too little space on the ROM. But I bet more people have accidentally lost a file this way than have been handicapped by the 40-column preview. Let's hope Computer Concepts does a fresh upgrade for occasionally absent-minded users like me.

Computer Concepts is at 16 Wayside, Chipperfield, Herts WD4 9JJ. Tel (09277) 69727.

Cambridge Computer Consultants is at Science Park, Milton Road, Cambridge CB4 4BH. Tel (0223) 862614.

The Aries File

CRUSHED BETWEEN AN IRRESISTIBLE FORCE AND AN IMMOVABLE OBJECT?

If your high-resolution screen is squeezing you from one side, and your operating system from the other, isn't it time you tried the ARIES solution? ARIES-B20 is the board which banishes forever the conflict between screen graphics and program memory. "bad mode" and "No room" become nightmares of the past when your Beeb possesses this unique expansion.

Unlike "sideways-RAM" systems, ARIES-B20 offers you *transparent* access to 20K of extra memory, replacing the RAM swallowed up by the high-resolution graphics modes. The extra RAM is switched in completely automatically, meaning that your existing software can make use of it *without modification*.

This means that if you're a programmer, you have up to 28K RAM available for BASIC, FORTH, LISP, BCPL, LOGO and COMAL programs in *ANY SCREEN MODE*. If you're a business user, the extra memory is used by

VIEW, VIEWSHEET, WORDWISE and many other applications. And if you're a scientific type, you can get access to a massive 47K of data storage using the Acorn-approved ARIES ★FX call.

COMPATIBILITY ASSURED

With the huge range of Beeb add-ons that are becoming available, compatibility has become a real headache. Every extra you buy your computer might lock you out from a host of others, even if it works with those you already possess.

ARIES-B20, designed by BBC Micro experts, offers you true upgradeability. In addition to the rest of the ARIES family (the ARIES-B12 ROM expansion board and the ARIES-B488 IEEE-488 interface unit), ARIES-B20 is compatible with double-density disc controllers, second processors, ECONET, hard discs, EPROM programmers and

much more. Several major companies now test all their products with ARIES-B20 to ensure compatibility.

PROFESSIONAL QUALITY

The ARIES range is designed to work with *all* BBC Micros, not just some of them. This means it has a sensible regard for the capacity of the power supply and the natural variations in critical timings between machines. All new ARIES products are subjected to brutal testing in extreme conditions before they are released on the market.

In quality of construction, the ARIES range sets a standard against which others are judged. Custom-made connectors eliminate the damage to the BBC machine caused by inferior products. Units are electronically tested before, during and after manufacture. And all this is backed up by the ARIES 1 year no quibble guarantee.

WHAT THE PRESS SAID

"the most exciting add-on"

- Times Educational Supplement, March 1984

"a very professional product"

- A & B Computing, March/April 1984

"an attractive solution to the lack of sufficient memory on the Beeb"

- Beebug, March 1984

"this is an impressive piece of equipment in its own right and deserves to be taken seriously"

- Acorn User, April 1984

"the trouble with a paged RAM system is that the software has to be aware that it is there. The Aries RAM board gets round this limitation brilliantly"

- The Micro User, June 1984

NOW AVAILABLE THROUGH DEALERS

To cope with the continuing growth of demand, the unique ARIES-B20 RAM expansion has now been made available through selected dealers. Although ARIES-B20 can be fitted by a complete layman in a matter of minutes, a fitting service is offered by approved dealers to those customers unwilling to delve inside the case of their BBC Micro.

The recommended retail price of ARIES-B20 is just £115 (inc VAT) for the B20 board, operating system extension ROM and detailed manual. Enquire at your local dealer or order direct by post from the Manufacturers (see below).

(Machine requirements: Model 'B', MOS 1.2. Hardware plugs into CPU socket, software uses one sideways ROM socket

How to order:

Send cheque or postal order made payable to:

Aries Computers
and forward to:

Aries Computers
Science Park, Milton Road,
Cambridge CB4 4BH
Telephone Cambridge (0223) 862614

Aries Computers is a division of
Cambridge Computer Consultants Limited.

Please send me (Qty.) ARIES-B20(s) at £115.00
(incl. P.P. & VAT)

I enclose a cheque/postal order made payable to

Aries Computers for £.

Signed

Name (block letters)

Address

Post Code.

ORBIT ORBIT ORBIT ORBIT ORBIT ORBIT ORBIT ORBIT ORBIT ORBIT ORBIT ORBIT ORBIT ORBIT ORBIT ORBIT ORBIT

ELBUG FOR THE ACORN ELECTRON

JOIN NOW
FOR A
FREE
CASSETTE

Join the Electron User Group

Members receive 10 copies of the magazine **ELBUG** each year. **ELBUG** is devoted **EXCLUSIVELY** to the **ELECTRON MICRO**. It is packed with News, Reviews, Hints, Tips, Programming ideas, Major articles, plus Regular program features including games and useful utilities.

ELBUG is produced by **BEEBUG** Publications Ltd., publishers of **BEEBUG**, the magazine of the National User Group for the BBC Micro. **BEEBUG** now has some 20,000 members and has achieved a high reputation both in this country and abroad.

The formula which makes **BEEBUG** an invaluable companion for users of the BBC micro, has been applied to **ELBUG**.

By subscribing to **ELBUG** you gain all the advantages of a single-micro magazine, with

no space wasted on programs and articles for other computers.

BENEFITS OF MEMBERSHIP

ELBUG MAGAZINE

Ten copies a year mailed free of charge.

DISCOUNT SCHEME

Extensive discount scheme with major retailers.

SOFTWARE LIBRARY

A growing range of software titles at budget prices for members.

SOFTWARE CLUB

Substantial discounts on software from major software houses.

LOCAL USER GROUPS

Lists of local affiliated user groups.

SPECIAL OFFER 8 FREE PROGRAMS

Subscribe now, and get a free introductory cassette containing 8 tested programs for the Electron.

1. **SPACE CITY**. Defeat the invading Aliens with your laser, and save the city
2. **3D NOUGHTS AND CROSSES**. Pit your wits against the **ELECTRON** on a 4x4x4 board
3. **RACER**. Guide your racing car to victory, avoiding other cars and obstacles on the track
4. **3D MAZE**. In this challenging game, you must escape from the maze - The screen displays a 3D view from inside the maze
5. **PATCHWORK**. A multicoloured display of continuously changing patterns
6. **KEY SET ROUTINE**. A program to set up the user function keys
7. **MEMORY DISPLAY**. An efficiently written utility to display the contents of memory (ROM and RAM)
8. **CHARACTER DEFINER**. Define individual graphics characters with this useful utility for use in your own programs.



SPACE CITY

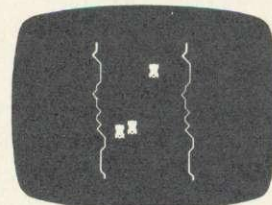

RACER

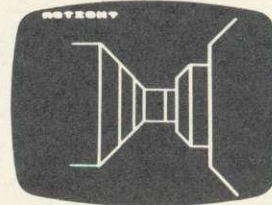

3D MAZE

HOW TO JOIN

To subscribe for one year, and get your FREE CASSETTE send £9.90 (payable to Orbit) plus a strong stamped addressed envelope (for the cassette)

SUBSCRIPTIONS TO: ELBUG, DEPT 13, PO BOX 109, HIGH WYCOMBE, BUCKS

Six months trial subscription (5 issues) UK only £5.90—FREE CASSETTE OFFER STILL STANDS
Membership outside UK (one year only): Eire and Europe £16.00. Middle East £19.00. Americas and Africa £21.00, other countries £23.00.
Editorial Address: ORBIT, PO BOX 50, St Albans, Herts.

John Vaux wraps up his Z80 bundle of reviews with a look at Nucleus and the languages

YOUR OWN MASTER FILES

113

IN THE first two articles on the 'free' software that comes with Acorn's Z80 second processor we looked at the *Accountant* book-keeping program, *MemoPlan* (a word processor), *GraphPlan* (a spreadsheet) and *FilePlan* (an indexed data storage program). Now we'll consider the remaining packages in the bundle and summarise the whole Z80 package.

NUCLEUS

This is a system generator written by Compact Software International, which also wrote *Accountant* (see July issue). It is a program that creates computer programs based on a menu-driven question-and-answer session with the user. Its usefulness is based on the fact that a large proportion of the activities in many business applications are similar, differing only in the structure of the data being processed. These operations are data input (including validation); data viewing, including sorting and selection; and updating, particularly of master files such as ledgers and printing reports from the data, possibly combining information from more than one file. *Nucleus* can generate programs to do all these things.

Using Nucleus

The documentation for *Nucleus* is in the same house style as the rest of the packages and is again very good. It contains easy to follow step-by-step instructions on how to do the various operations and useful information on how to design your system. An example system—a school records system—is used to illustrate how to build up quite a useful set of programs. On-screen help is displayed as the operation continues, telling you what is going on and prompting you.

Like *Accountant*, the whole operation starts from the start-of-day disc. The program asks you for the date and then a program disc. This is the last you see of the start-of-day disc unless you need to restart the system.

Running *Nucleus* involves a lot of disc changing. Apart from the start-of-

already been done for you in this package.

2. Create a system definition. This has the name of the system and a system code (used for generating program names, etc).

3. Create file definitions. With this you indicate if it is a master file or a transaction file and enter details of each data field (name, length, type and so on). At this stage you also specify the key field or fields to be used for direct access to your file. Up to five key fields may be specified, but more than two slows down the processing time noticeably.

4. Create update program. You specify here the file and fields to be updated, and a data input screen is automatically generated. If you do not like the screen layout provided you can change it. While it is generating the program it shows on the screen the number of lines created so you can see that something is happening. A typical simple update program contained 130 lines and took just over a minute to generate.

5. Create file linkage.

This is an optional feature but a powerful one. Two files may be linked via a key field to enable automatic updating of one from the other

(for example, updating of master file from transaction file) or automatic picking up of data for validation or printing (for example, fetching a description for a code). Full explanations of how to design and implement linked files are in the manual.

6. Print file definitions. This option prints details of the file, including the generated file name—in case you want to do clever things with the data. It also prints a specification of all the fields, including their positions in the record.

7. Create master file print program. This and subsequent options are in the

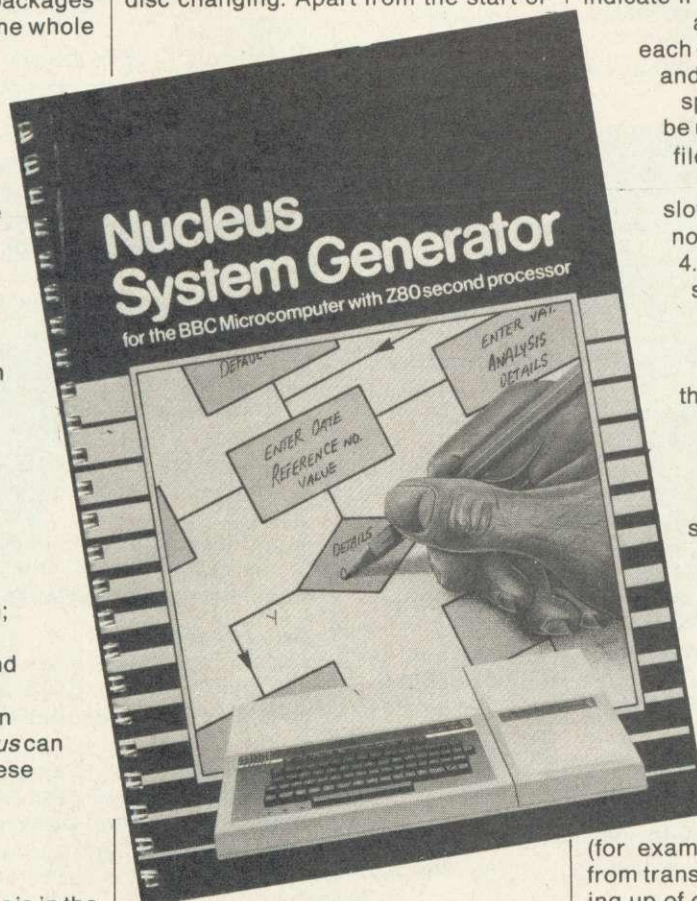

day disc there are three *Nucleus* discs—definition, reporting and parameter file—and discs for your created programs and data.

All I have space to do is summarise the operations required to set up a system.

1. Create a parameter file if one does not already exist. This procedure need be done only once and indeed has

A little bit of magic from MERLIN COMPUTER PRODUCTS

AN UNBEATABLE COMBINATION! A WORD PROCESSOR
AND DATABASE WHICH CAN BE INTEGRATED.

MERLIN SCRIBE

The first professional
word
processor
for the
BBC disc
system.

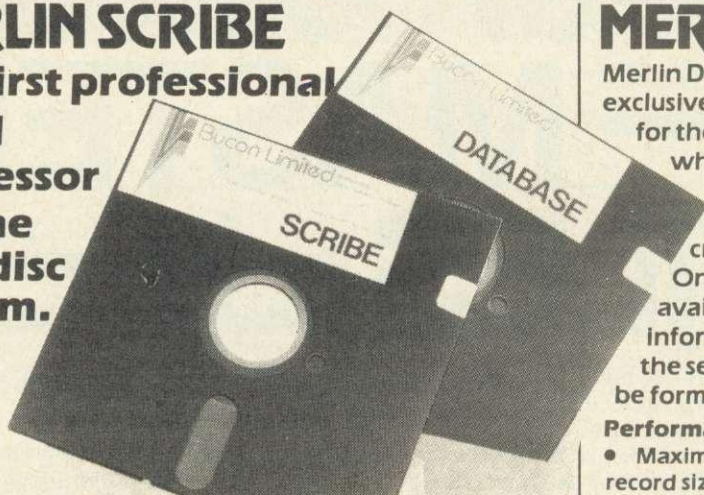

Among the many features available are:

- Create up to 255 pages in a single document.
- Screen user selectable 40 or 80 column with choice of background and text colours.
- Insert text at any page on the document whether currently in memory or not.
- Powerful editing commands: Move, copy and delete with affected text displayed in reverse video. Will move or copy within a page or to any other page in the document.
- Word search and replace — item by item or globally throughout the document.
- "Go to page" — next and previous using up and down cursor keys or go directly to page numbers
- On screen underlining.
- Format line controls document width and allows setting of right and left margins.
- Tabs set on format line as required.
- Automatic centre and decimal tab.
- Text reformatting.
- Split page and dynamic page break display.
- Word count and display of cursor position by column & line number.
- Will use disc surfaces 0 to 3 as allowed by the BBC system.
- All disc filing operations menu driven, eg. re-name, copy, delete document, compact and catalogue disc, etc. No knowledge of the disc system required.
- Exec document — allows conversion of BASIC programs for editing by word processor and then re-conversion back to either text or program files.
- File merge — one or more documents or other text files may be merged in sequence from any disc drive between 0 and 3.
- Automatic page numbering with page number insertion at any point on the page.
- Headers and footers.
- Total facility print module including selection of serial or parallel output, global printer control codes, page numbering offset, print from page to page, repeat print, etc.
- Selection of up to nine user definable keys for insertion of printer control codes into text, with up to five codes allocated to each key.
- Control number of page display lines for scroll speed increase.

The program comes attractively packaged in a simulated leather grain wallet which contains the manual, disc, chip & function key legend strip.

MERLIN DATABASE

Merlin Database is a database system designed exclusively for the BBC disc based computer. It provides for the structural input of text and numerical data which is stored permanently as a record on the computer. A group of records constitutes a database. Any number of databases may be created using Merlin Database.

Once created there are sophisticated facilities available for searching, selecting and drawing off information from the database by means of defining the search characteristics. This information can then be formatted for producing printed reports, lists etc.

Performance

- Maximum records per database 4000
- Maximum record size 1800 characters
- Maximum no. of fields 32
- Maximum no. of characters for any single field 900
- Find any record in 2 seconds via key field access
- Search every character in a 100 kb database in 29 secs

Field Types

- Numeric — up to 9 digits
- Date
- Sub fields for economic disc usage i.e. specify average & maximum field size

Data Search

- Search results directory held with database on disc
- Data can be passed to mail merge and report writer
- 16 level conditional search
- Search conditions include 'not', '>', '<', '='.
- Wild card
- Database automatically sorted by key field
- Database can be set to re-sort to any alternative set of key fields

Report Writing

- Database will integrate with Merlin Scribe word processor
- Format printer output with simple forms editor
- High powered forms layout & editing using Scribe (alls. rt. justify)
- Arithmetic calculations & accumulators
- Conditional report writing
- Semi programming facility for forms & report generation

Other Facilities

- Mail merge using Scribe
- Conditional mail merge
- Automatic reformatting of lines
- Capable of conditional transfer of information between databases.

Database comes in chip with manual, simple fitting instructions & systems disc. Also planned is the production of Database integrated with the Merlin Scribe word processor in a single chip although the database is designed to integrate easily with Scribe in a separate chip.

MERLIN DATABASE £49.00
MERLIN SCRIBE £59.95
MERLIN SCRIBE/DATABASE £95.00

Prices include VAT. Price and specification subject to change without prior notice.

Credit card orders accepted. Special discounts for educational establishments and dealers.

MERLIN COMPUTER PRODUCTS (BUCON LTD)
35/36 SINGLETON STREET, SWANSEA SA1 3QN
Tel: (0792) 467980 (3 lines)



reporting section of *Nucleus*. This gives a simple print of a master file.

8. Create selected report program. This gives you a more complex print of any file. You may specify headings, which fields are to be printed and any values to be computed. You may also select and/or sort your data records and create totals.

9. Label printing. This is a program for printing out labels from your files on continuous label paper. To allow for small variations in label printing paper you may specify width to the nearest tenth of an inch and height to the nearest sixth of an inch.

10. Standard letters. To generate a continuous run of standard letters from a file (say, for a mail shot) this is the program to use. It has its own simple word-processor to input the text of the letter and you indicate where the variable text from the file is to appear.

11. Document writer. This is similar to the standard letter option but instead of generating a letter for each record it generates a report with an inbuilt listing of the data incorporated. This is a rather complex routine and in the short time available to look at it I was not able to make it work fully. Careful study of the manual and a step-by-step approach should eventually give results.

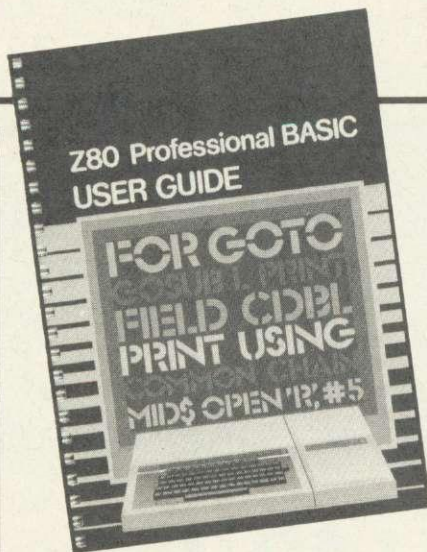

ity discs with reinforced centres should be used. Having said that it is certainly possible for intelligent non-programmers to use it and it is a worthy addition to this bundle of software.

LANGUAGES

Two versions of Basic and CIS Cobol are provided. The two Basics are the Z80 version of BBC Basic and a 'Professional' Basic more like the traditional Basics that have been around for some time.

BBC Basic is virtually identical to that provided with your BBC micro. A small manual is provided giving the differences between them, the main one of course being that the built-in assembler is Z80 code rather than 6502. Other differences are to do with the CP/M operating environment. A utility program called *Dip* is provided to enable programs to be copied from DFS disc format to CP/M format. Also on the disc are the well-known 'Welcome' programs, which all worked like the originals.

Professional Basic is a 'run only' implementation. This means that there is no built-in editor for interactive development of a program. This Basic reads and executes Basic ASCII source code programs. The idea is that you take the ASCII files of existing business programs and, provided you can get them copied onto BBC discs, you can run them unchanged on the Z80 second processor. They can, of course, be edited using a wordprocessor such as *MemoPlan*, or new programs may be written in the same way.

Benchmarks on the two Basics and on 6502 BBC Basic were as follows:

<i>Prime numbers to 5000 (Sieve method)</i>
6502 48 secs
Z80 38 secs
Prof. 30 secs
<i>PCW Benchmark No. 7.</i>
6502 22 secs
Z80 17 secs
Prof. 15 secs

As BBC Basic is known to be fast, the

fact that Professional Basic is even faster is quite impressive.

You are either a Cobol programmer or you are not. For the Cobol enthusiast this is a full implementation of this well-known version of Cobol, complete with 'Forms2' screen designer and 'Animator' debugging tool for stepping through your program. The retail price of this alone is way above the price of the Z80 second processor.

OVERALL CONCLUSIONS

The Z80 second processor runs the CP/M operating system, which is the standard for eight-bit micros. This potentially gives you access to the hundreds of application packages written for that system. All that is required is for the package to be made available on BBC disc format and for it to be configured for the BBC micro's screen and keyboard control sequences.

Most good packages have a configure program to achieve the latter. No doubt the software distributors are



already working on this. In fact, Software Limited is promising 300 packages 'soon' (July issue, page 9). In the meantime Acorn has provided this free bundle of software. Many people will not need to buy any more, as there is something for everyone. In fact they are unlikely to find a use for all the software provided.

All of it is professionally written and documented and I rate it from good to excellent. I thoroughly recommend the Z80 second processor with all its free software to anyone with a BBC micro wishing to upgrade to a full business system. Indeed, it should be considered as a cost-effective way to obtain a business system even if you haven't already got a BBC machine. The main problem is the amount of desk space required as nothing can really stand on anything else.

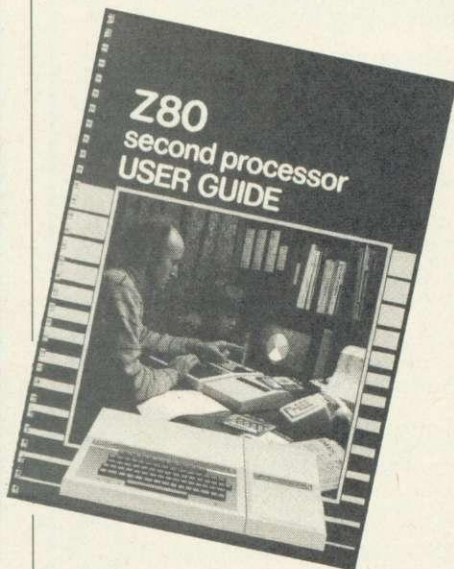

Conclusion

The above brief summary is an indication of what you can do with *Nucleus*. As long as you don't require your system to do clever data manipulation, you should be able to design and implement a fairly complex system in a matter of days instead of the weeks or months it would take with traditional programming languages. It tends to become a bit fiddly at times with lots of 'Details OK (Y/N)' prompts to answer and lots of disc changes, so good qual-

Tandy® The Tandy® Four Colour Graphics Printer

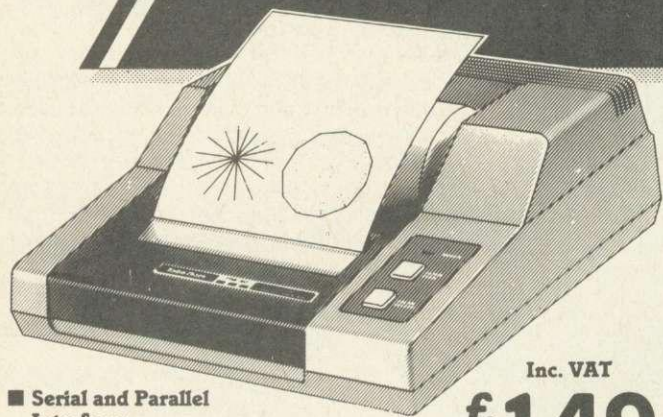

- Serial and Parallel Interfaces
- Easily Replaceable Ink Cartridges

Inc. VAT
£149

CGP115. Compact TRS-80 colour printer creates beautiful graphics in red, blue, green and black. Text mode prints 40 or 80 characters per line at 12 characters per second. Includes serial and parallel interfaces and easily replaceable ink cartridges and standard 4 1/2" paper rolls.
26-1192 £149.00

Model 100 Printer Cable. 26-1409 £9.95

Take A Look At Tandy, Today!
See Our Extensive Range of Microcomputer Accessories
At Any One of the 350 Tandy Stores Nationwide!

Prior to this advertisement, all quoted regular prices have been charged during the last six months at the Tandy Store, Tameway Tower, Bridge Street, Walsall, West Midlands, WS1 1LA

Known As Radio Shack In The U.S.A.
Prices may vary at Dealers
Offers Subject to availability

2 NEW BUSINESS SOFTWARE PROGRAMS FOR THE BBC MICRO

MAIL LIST £34.95
inc. VAT & p/p
STOCK CONTROL £34.95
inc. VAT & p/p

HUGE STORAGE CAPACITY
UP TO 1600 FULL ENTRIES

FAST WRITE AND READ CAPABILITY

EASY UPDATES AND AMENDMENTS
WITH COMPREHENSIVE MENU

FULLY AUTOMATIC ALPHA-SORTING

VERY USER FRIENDLY

FULL COLOUR GRAPHICS UTILISED

EASY TO FOLLOW USER GUIDE MANUAL

DISK ONLY * PRICES INCLUDE VAT & DELIVERY BY REGISTERED MAIL WITHIN 10 DAYS
EITHER PROGRAM £34.95 * BOTH TOGETHER £60 * STATE SINGLE OR DOUBLE DRIVE. 40/80 TRACK
CHEQUE/P.O. PAYABLE TO MLC COMPUTERS LTD * FULLY GUARANTEED

MLC

DEALER ENQUIRIES WELCOME

PEAR TREE MEADOW • ELLINGTON THORPE • HUNTINGDON • CAMBS ☎ 0480-811573

HARRIS McCUTCHEON SYSTEMS

are pleased to release

HMS HOME ACCOUNTS.....	£28.75
HMS VAT TRADER'S LEDGER.....	£21.50
HMS BASIC ENVIRONMENT.....	£14.50

to BBC Microcomputer users with a minimum configuration of 1 x 40 track single sided disc and an 8" 132-column (condensed mode) printer, to a maximum configuration of 2 x 80 track double sided disc and a 15" printer. The programs allow user allocation of each file between * DRIVE 0, 1, 2 or 3, thus making full use of the disc space available.

HMS HOME ACCOUNTS allows all financial transactions within a defined environment to be recorded, printed and analysed. Accounts may be reconciled with statements or passbooks, uncleared entries being highlighted. Depending on the analysis structure you choose, the system can keep track of anything from answering "how much is in the piggybank?" to independent tracking of multiple bank accounts, credit cards, building society accounts and cash in hand. The only reason for keeping home accounts in any form is to have your current financial state apparent on demand and reconcile statements received in order to find out where the money goes. This program is designed expressly for these requirements. You wouldn't keep them if these areas were of no concern, and being of concern you want to keep them thoroughly and effectively. HMS HOME ACCOUNTS allows this.

HMS VAT TRADER'S LEDGER, on the other hand, fulfills a different requirement. Instead of emphasizing analysis, the VAT trader wants to record all his invoices and bills in the least time possible consistent with making out the quarterly VAT return and getting a well-presented ledger listing on demand. Varying and multiple VAT rates are of course catered for. Add the facility to maintain period totals on user-defined bases other than VAT quarters (such as weekly, monthly and to the end of each trading account), and HMS VAT TRADER'S LEDGER should be a boon to you as a sole trader through to the low transaction company.

Both systems allow for 1000 to 10000 records per file depending on configuration and use, and initialise on shift-BREAK without user OS intervention. Fully documented source listings and optional user-modifiable VIEW text operating documentation are included on the master disc, and hard copy manuals are provided.

HMS BASIC ENVIRONMENT is specifically an aid to BASIC program development designed to encourage the creation of well-structured readable code in circumstances where memory becomes a constraint. Procedures to handle screen I/O, cursor switching, CLI invocation, and keyboard validation are provided, with a linking BASIC source file compressor which includes variable name compression to two bytes. The ability to link as many BASIC source modules as desired into a single condensed running version resolves the coder's conflict between space and intelligibility; 60% compression is effected on our sources for the above accounts packages.

The disc, manual and information contained are sold under license subject to the condition that they are for single user single site application by or on behalf of the purchaser, are not for resale in whole or in part either as originals or copies, and may not be supplied to a third party as part of a package or used as part of a package supplied by a third party to the purchaser, without the written consent of the copyright holders. Damages will be claimed where this occurs, with revocation of license. Purchase indicates acceptance of license terms.

I enclose £..... for the following products (tick and delete where appropriate)

HMS HOME ACCOUNTS (£28.75).....
HMS VAT TRADER'S LEDGER (£21.50).....
HMS BASIC ENVIRONMENT (£14.50).....

VAT, disc, manual, post and packing inclusive.

The credit card companies 4% take precludes our offering their service.

Please supply on 40/80 track disc. I have VIEW/WORDWISE; OS 1.0/1.2; BASIC I/II

Name.....

Address.....

..... Postcode.....
Telephone..... Date.....

Please send with cheque or postal order to: Harris McCutcheon Systems, 40 Huntingdon Street, London N1 1HM (01 609 3207)

ACORNSOFT/MI

A complete easy-to-use business package for the BBC Microcomputer

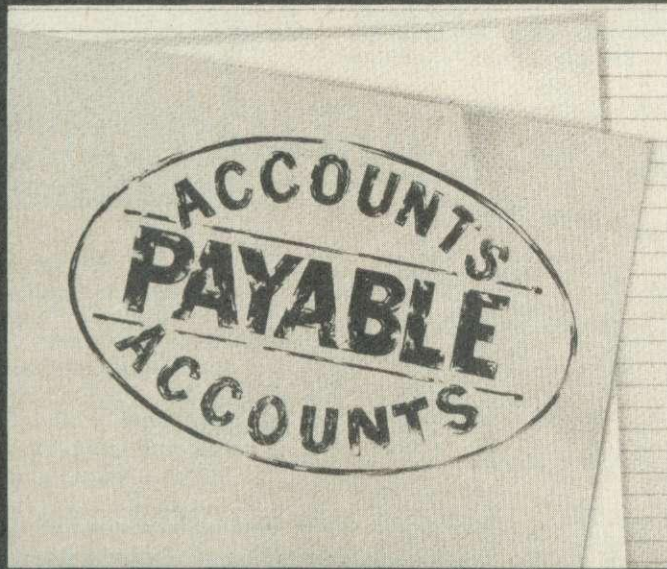

LIVE

LEDGERS

Paul Beverley rounds up the last of the Acornsoft business suite, the small company accounts packs

'Accounts Payable' and 'Accounts Receivable', Acornsoft, £24.95 each (inc VAT)

ONE OF the difficulties of using micros for doing the accounts for a small business is that no two applications are alike. The solution would be an accounting system tailor-made for your business, but this would be too expensive for most small businesses, so we have to rely on off-the-shelf accounting packages.

The problem is, which one best suits your requirements? Writers of accounting packages have to avoid the extremes of having too many facilities, making the package slow, cumbersome or expensive, or not enough of them to give the package appeal to a large enough market.

These two Acornsoft programs have a wide range of facilities, but are not excessively expensive, though for most applications you will need both *Accounts Receivable* and *Accounts Payable* (if anyone knows of a business which only receives payments and does not have to make any, let me know!). So really you have to think of these two programs as making up a system costing virtually £50.

The other point to consider is whether you want just an accounting package or whether you also want some of the other facilities aimed at small businesses that Acornsoft has produced alongside the accounts packages. These include *Invoicing*, *Order Processing*, *Stock Control*, *Purchasing* and *Mailing List* (see reviews in the

ACCOUNTS PAYABLE

Purpose - maintain the purchase ledger, analyse input VAT, produce remittance advices and creditor analyses

- Supplier Update
 - New Entries
 - Enquiry
 - Amendment
 - Deletion
 - List All Records
- Ledger Postings
 - Invoice Entry
 - Credit Note Entry
 - Adjustment Entry
- Remittance Advice

This updates the purchase ledger and prints remittance advice notes to accompany payments
- VAT Analysis
- Account Analysis
 - Account Enquiry
 - Aged Creditor Analysis*
- Close Ledger

This deletes from the purchase ledger all transactions (before a certain date) which balance at zero, thus cleaning up the ledger and saving file space

Figure 1. Sub-menus of the 'Accounts Payable' package, set out as headings and sub-headings

June issue). This present review does not extend to any of these modules, but the idea of the system as a whole is that you make use of common data files, so that as you add more customers or suppliers you need change only one file.

These are disc and printer based systems - you can't run them without having both. You could get away with a single disc but this would involve a lot of changing of discs since the system programs are held on a different disc from the data. It would be possible to put the data on the programs disc, but on a 100k drive it wouldn't leave much room for the data file - less than 20k, in fact.

When setting up your system, the first thing to do is put in your own business information, tell it which of the modules you are using and what sort of printer and disc system, and set up your data files for suppliers and/or customers. You then go in through a series of menus to the facility you want.

To give some idea of the facilities here are the menus available beyond the main menu of system set-up, listed as headings and sub-headings (figures 1 and 2).

As with much Acornsoft material, these packages are very professionally produced. I test software by deliberately trying to enter all the wrong responses I can, but at no point could I get

either of them to do anything wrong. The screen presentation is clear and, generally speaking, the speed response good, though I had only very small files to work.

The manuals are well set out and explain clearly what each function does and how to operate it, though most of the time the programs are self-docu-

menting and tell you what inputs are necessary. Because the system as a whole covers so many different functions – invoicing, mailing and so on – the format for entering information on customers and suppliers is rather rigid and asks for information which you may not want to use. However, it does mean that if you decide later on that one of the

ACORNSOFT/MI

A complete easy-to-use business package for the BBC Microcomputer

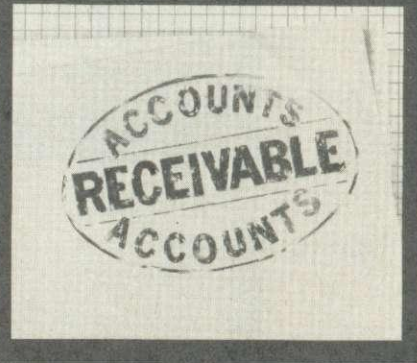

other modules would be useful – say, invoicing – it's easy to build that module into your system.

This is a very professionally produced system, is very easy to use, and you get a lot of facilities for your money. If the other modules are as well produced as these then the more you buy, the better value for money you get.

ACCOUNTS RECEIVABLE

Purpose – maintain sales ledger, analyse VAT, produce customer statements and debtor analyses

- Customer Update
Sub menu as in 'Accounts Payable'
- Ledger Postings
 - Invoice Entry
 - Credit Note Entry
 - Amendment
 - Deletion
- Cash Allocation
Posts payments to account, either 'open item' when pay-

ments are allocated to specific invoices or 'brought forward' when they are allocated to the latest invoice

- Select Account Type (O/I or B/F)
- Cash Allocation
- VAT Analysis
- Account Analysis
 - Account Enquiry
 - Customer Statements
 - Credit Limit Report
 - Aged Debtor Analysis*
- Close Ledger
As 'Accounts Payable'

**Aged debtor and creditor analyses refer to unpaid invoices. What it means is that you get an analysis, either by week or by month, of all outstanding payments – ie, who has owed you what and for how long, or to whom you owe money and for how long you have owed it.*

Figure 2. Sub-menus of 'Accounts Receivable'

118

SYSTEM SOFTWARE

Write your own compositions for the BBC microcomputer with



- full GRAPHIC display showing treble and bass staves
- VERSATILE SCREEN EDITOR with single key input
- up to 1,000 note compositions on tape (800 on disc)
- SAVE your music/sound effects on disc or tape
- write in ANY KEY; sharps and flats are put in automatically
- up to 3 VOICES
- redefine up to 16 ENVELOPES
- HEAR the notes as you enter them
- FULL DOCUMENTATION in USERS GUIDE
- PLAYBACK any tune/sound effect IN YOUR OWN PROGRAMS
- completely compatible with the graphical ENVELOPE GENERATOR program which is still available from SYSTEM at £7.00 inc vat disc or tape

6 It's a gift to every frustrated composer, thwarted music teacher and parent who wants to give a child something that is amusing yet educational. And it's so much fun to use!
This excellent piece of software was a pleasure to review. Thoroughly recommended. 9

Micro User Dec 83

6... you are presented with a well laid out editing mode, with which you enter the notes.

The Music Editor system allows creative use of the Beeb's sound capabilities. ... 9

Acorn User April 84

Disc or Tape OS 1.0 and above **£9.00 incl. vat**

Please enclose cash with order or an official order form.

SYSTEM Dept. A 12 Collegiate Crescent Sheffield S10 2BA (0742) 682321



QUIXLEARN

The System That's An Education In Itself

COMPUTER BASED AUTHORIZING

If you are involved in teaching, whether in school or industry whatever your subject then QUIXLEARN will interest you. No need to search for ready-made educational software. QUIXLEARN now enables you the teacher to design and write teaching material.

You need have no programming experience. QUIXLEARN is easy to master but with powerful facilities.

Construct lessons containing text and pictures in colour using TELETEXT characters or your own set of 128 graphics characters. Include questions for the student to answer – you decide how the lesson proceeds. Link a lesson to cassette tape for simultaneous audio instruction. Set up your own libraries of text and pictures for use in different lessons. Ideal for preparing lectures, training courses, advertising material and demonstrations.

Designed to be used with the BBC Model 'B' (OS1.0) and disks. (5 1/4")

QUIXLEARN is supplied on disk, with audio cassette, and instructional material included. The disk and cassette contain a lesson which will teach you how to use the system. Price £75 (incl. VAT + P&P)

State 40 or 80-track DISK DRIVE

Payment with order to:

QUIXTOR LIMITED, 7 HASLEMERE AVENUE, HALE BARN, WA15 0AU.

QUIXLEARN was developed as part of an Open Tech project.

VIGLEN

branches out

to offer the best value in monitors & printers

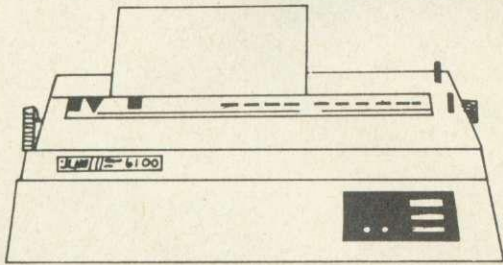

**NEW
SPECIAL
OFFERS**

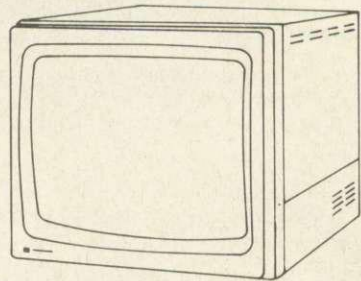

Dot Matrix Printers

Epson RX80/FT **£269.00**
80 cps with friction & tractor feed.
A reliable printer competitively priced.
Epson FX80 **£379.00**
Canon PW 1080 A **£339.00**
160 cps with near letter quality printing
including friction & tractor feed.
Cosmos **£209.00**

Colour Monitors

Microvitec standard 1431 **£199.95**
Microvitec medium 1451 **£315.00**
Microvitec high 1441 **£442.00**
Philips 14" TV/monitor **£235.00**
(RGB Input)

Daisywheel Printers

Juki 6100 **£375.00**
Epson DX100 **£450.00***
SAN PLE 2000 **£299.00**
*Previously £499.00 Limited Stock

Monochrome Monitors

Philips 12" Green V2001 **£75.00**

1½ metre length printer leads for BBC Micro **£8.00**
All prices include VAT.

Please add £8.00 for carriage.

We also stock other computer peripherals, accessories and complete work processor systems at unbelievable prices. Please call for our latest offers.

You may also purchase these items direct by calling at our factory/showroom in Hanwell, London.

Prices correct at time of going to press and offers subject to availability.

Post to: VIGLEN COMPUTER SUPPLIES UNIT 7, TRUMPERS WAY, HANWELL W7 2QA

Please send me (state number required)

I prefer to pay ACCESS/BARCLAYCARD (Delete whichever is not applicable)

Card No. _____ Incl. £8 carriage. Cheques payable to Vigen Computer Supplies.

Signature _____ card holder. Address below must be the same as card holder.

Name _____

Address _____

AUG/1

HACKERS!

SEE US AT

The 2nd
Official
Acorn User
Exhibition

OLYMPIA
16-19 AUGUST
1984

HERE, NOW, AN ADVANCED MODEM
ESPECIALLY DESIGNED FOR YOU AND
THE BBC MICROCOMPUTER.
ONLY THE LOCO SYSTEMS SCM-100
OFFERS ALL THESE ADVANCED
FEATURES:

- MULTI STANDARD - V21, V23; BELL 103,202 - gives access to Bulletin boards home and abroad and Prestel
- FULL SOFTWARE CONTROL of all modes plus: orig/ans; line seize; carrier detect etc., using BBC micro user port
- AUTO ANSWER - software monitoring facilities give automatic mode selection on answer
- OPERATING SOFTWARE in ROM gives 12 new O.S. commands for easy control
- COMPATIBLE WITH standard comms software including TERMI etc.
- EXPANSION PORT in modem allows for future developments. These include telephone answering capability using BBC speech synthesiser and tone/pulse dialler
- POWERED FROM BBC MICRO - splitter available for use with discs if required
- B.T. APPROVED ISOLATION COMPONENTS - BAPT approval applied for
- INCLUDES ALL CONNECTING LEADS

THERE IS ONLY ONE CHOICE

LOCO SYSTEMS



LOCO SYSTEMS, PO BOX 9, TWICKENHAM, MIDDX.

Please send me _____ SCM-100 software controlled modems @ £149.95 each. _____ Disc power adaptor @ £5.95 each

I enclose a cheque/PO order for £ _____ made payable to Loco Systems

Please send me further details (enclose S.A.E.) _____

Name _____

Address _____

please allow 28 days for delivery

ATOM ATOMIC MACHINE CODE

A book containing 23 fully explained machine code programmes for the Atom.

DATA SORTS ● MODE 4 CHARACTERS ●
GAMES ● POOLS PREDICTION ● TOOL KIT ●

Over 50K of programmes in 1 book for £5.75 inc.
Book and Cassette (source code) £15.50.
Book and Cassette (ready to run) £15.50.
Cassette only £11.50.

BBC ATOM LOAD

If you now own a BBC don't throw away your tapes, for ATOM LOAD allows you to load Atom tapes directly into the BBC Micro (Model B).

BBC-TYPE BASIC ● ATOM BASIC ● ATOM
TEXT FILES ● ATOM MACHINE CODE ●
ATOM DATA FILES ●

Checks for Syntax differences, checks for direct addressing of memory, disassembles machine code, and in all cases flags possible errors.

On Cassette - All this and more for only £9.75 inc.

ECCE Productions, 3/73 Station Road,
Sidcup, Kent. DA15 7DR.
01 302 1667. (Mail order only)

DUCKWORTH HOME COMPUTING

EXPLORING ADVENTURES ON THE BBC MODEL B by Peter Gerrard £6.95

This is a complete look at the fabulous world of Adventure Games for the BBC Computer. Starting with an introduction to adventures, and their early history, it takes you gently through the basic programming necessary on the BBC before you can start writing your own games.

Inputting information, room mapping, movement, vocabulary - everything required to write an adventure game is explored in detail. There follow a number of adventure scenarios, just to get you started, and finally three complete listings written specially for the BBC, which will send you off into wonderful worlds where almost anything can happen.

The three games listed in this book are available on one cassette.

BBC PROGRAMS 1 Edited by Nick Hampshire

This book provides you with a range of useful and exciting programs for the BBC Micro. Games, utilities, graphics and functional programs are covered. The games include an exciting version of Star Trek, a full length adventure game, Space Invaders, Battleships, Space Blaster, Brick Basher, and many others. Among the functional programs is a personal information retrieval package which enables you to create and manipulate up to 365 records. This is a basic book for every user of the BBC Micro.

Written by Carl Graham and edited by Nick Hampshire, publisher of *Commodore Computing International*. £6.95

Write in for a catalogue.



DUCKWORTH

The Old Piano Factory, 43 Gloucester Crescent, London NW1 7DY
Tel: 01-485 3484

Put an end to inefficient, slow cassette tape storage



Speed your data access with a TEAC disk drive from Viglen

Comprehensive, fact-filled, 53 page manual including techniques of loading from cassette to disc. Not available elsewhere



Replacing your cassette with a disk drive means data access in seconds! VIGLEN TEACS *unlike others* have been specially modified to operate successfully with ACORN and other filing systems, over coming RANDOM accessing problems normally experienced with these disk drives. Prices include VAT, Formatting Disk, User Manual, Case and Leads.

When ordering Dual Drives, please state which layout you prefer A or B.



TEAC 55 Slimline Drives

SINGLE DRIVES CASED	Incl. VAT	Excl. VAT	DUAL DRIVES CASED	Incl. VAT	Excl. VAT
40 TRACK 100K	£143.76	£128.00	40 TRACK 200K	£287.50	£249.57
40 TRACK 200K	£195.00	£169.56	40/80 TRACK SWITCHABLE 400K	£358.00	£311.30
40/80 TRACK SWITCHABLE 200K	£179.00	£155.65	40/80 TRACK SWITCHABLE 800K	£450.00	£391.30
40/80 TRACK SWITCHABLE 400K	£225.00	£195.65	DFS KIT - Acorn or C.U.C.	POA	POA
			Disc Filing System 100% Acorn Compatible		
			Integral Power Supply	£30.00	£26.09

All prices correct at time of going to press and all offers subject to availability.

● Utilities disk includes 13 useful utilities including: ● formatting ● verifying ● screen dump ● disassembler ● generating 62 files, etc.

● Orders welcomed from Educational Establishments and Government Departments.



Full Twelve Months Guarantee

How to order

By post: To purchase any of the items simply fill in the coupon with your requirements. Enclose your Cheque/P.O. or use your Access/Barclaycard. Please make cheques payable to: VIGLEN COMPUTER SUPPLIES and post to above address. Allow seven days for delivery and add £8.00 carriage, package and insurance on all items.

By telephone: Ring (01) 843 9903. Credit Card holders (Access/Barclaycard only) can purchase by telephone. Please give Card No., Name, Address and the items required.

Viglen

COMPUTER SUPPLIES

Unit 7 Trumplers Way
Hanwell W7 2QA
Tel: (01) 843 9903

EASY ON-THE-SPOT PARKING. AND IT'S FREE!
Post to: VIGLEN COMPUTER SUPPLIES UNIT 7, TRUMPERS WAY, HANWELL, W7 2QA

Please send me the following items:
I enclose Cheque/P.O. for &
I prefer to pay by ACCESS/BARCLAYCARD* Card No. 751
Signature _____
Name _____
Address _____

Add £8 carriage. *Delete as necessary

TEC ● Viglen ● TEC ● Viglen ● TEC ● Viglen

TEC DRIVES

(As used by Cumana)

	Inc VAT	Excl VAT
Single sided 40 TRACK 100K 5 1/4"	£129.00	£112.17
Single sided 40/80 TRACK 200K switchable 5 1/4"	£169.00	£146.95
Double sided 40/80 TRACK 400K switchable 5 1/4"	£199.00	£173.04
For Dual-TEC drives the price is double the single drive prices		
Integral Power Supply	£30.00	£26.08

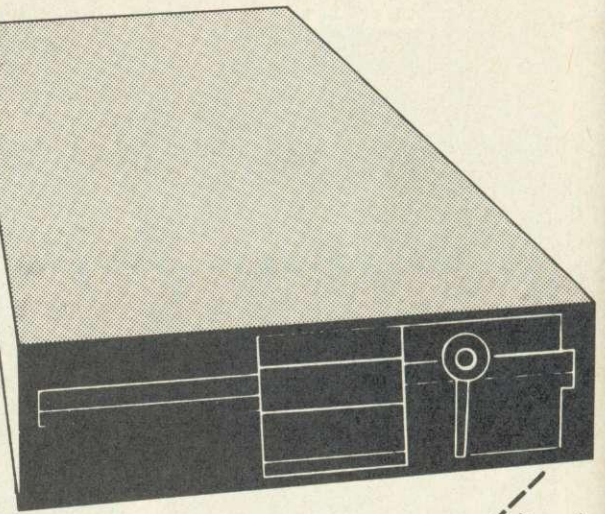

Please add £8 for carriage

All disc drives complete with Professional Case – Ribbon Cable to connect to BBC Micro – Power cable to connect to BBC Micro – Comprehensive Manual – Formatting and utilities disc.

Viglen

COMPUTER SUPPLIES

Unit 7 Trumpers Way
Hanwell W7 2QA
Tel: (01) 843 9903

Post to: VIGLEN COMPUTER SUPPLIES UNIT 7, TRUMPERS WAY, HANWELL, W7 2QA
Telephone: 01 843 9903. Personal Callers Welcome

Please send me

I enclose Cheque/PO for £

I prefer to pay ACCESS/BARCLAYCARD (Delete whichever is not applicable)

Card No. _____

Signature _____

Name _____

Address _____

Use for payment: Cheques payable to Viglen Computer Supplies
and other orders may be sent to
Viglen Computer Supplies
Unit 7 Trumpers Way, Hanwell, W7 2QA

BS

AU 9/6

LIMITED OFFER FROM

Viglen

COMPUTER SUPPLIES

Unit 7 Trumpers Way
Hanwell W7 2QA
Tel: (01) 843 9903

BBC MODEL B : £369.00 incl VAT

**BBC MODEL B
FITTED WITH ACORN DFS : £459.00 incl VAT**

PLEASE ADD £8.00 for carriage

OFFER WHILE STOCKS LAST

Post to: VIGLEN COMPUTER SUPPLIES UNIT 7, TRUMPERS WAY, HANWELL, W7 2QA
Telephone: 01 843 9903. Personal Callers Welcome

Please send me

I enclose Cheque/PO for £

I prefer to pay ACCESS/BARCLAYCARD (Delete whichever is not applicable)

Card No. _____

Signature _____

Name _____

Address _____

Use for payment: Cheques payable to Viglen Computer Supplies
and other orders may be sent to
Viglen Computer Supplies
Unit 7 Trumpers Way, Hanwell, W7 2QA

BS

PHILIPS 14" COLOUR TV/MONITOR

£235 inc VAT

TV/Monitor (resolution better than 585 x 450 pixels. Dot-to-dot distance .65mm)

(TV only: £185 inc VAT)

As a company we chose the Philips because we believe it to have the clearest picture as well as being the best value. Take our word for it, or come and see for yourself.

EASY ON-THE-SPOT PARKING. AND IT'S FREE!

Viglen
COMPUTER SUPPLIES

Plus £8 carriage and packing

Personal Service & Quality coupled with Wholesale Prices, Unit 7 Trumpers Way, Hanwell, London W7 2QA. Telephone: 01-843 9903

For special attention to your orders or enquiries concerning MONITORS, PRINTERS, COMPUTERS, DISC DRIVES, ring 01-843 9903 NOW or fill in the coupon below.

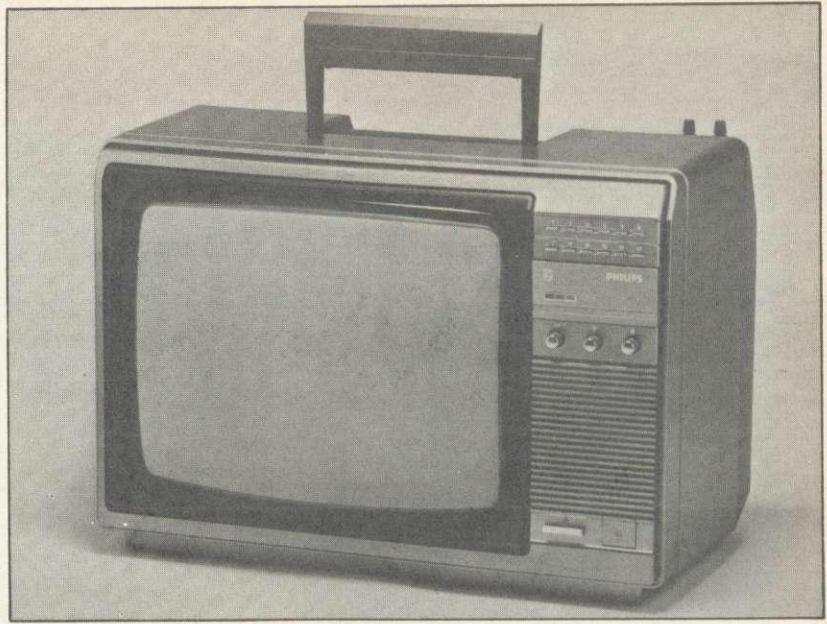



- Easy to carry • Lightweight • Sparkling picture in seconds • Reliability and performance excellent • Headphone Socket can also be connected to tape recorder • Loudspeaker mute switch • Retractable carrying handle
- Monitor/TV selected by switch • Includes RGB lead connecting direct to your BBC Micro. • Philips Model No. 14CT 2006/05T

Post to: VIGLEN COMPUTER SUPPLIES, UNIT 7, TRUMPERS WAY, HANWELL, LONDON W7 2QA.

Please send me _____ (qty) Philips TV/Monitor at £243 each. I enclose Cheque/P.O. for £ _____ made out to

VIGLEN COMPUTER SUPPLIES or debit my ACCESS/BARCLAYCARD No. _____

Name _____   Signature _____

Address _____ AU 9/3

NEW!

from

Viglen
COMPUTER SUPPLIES

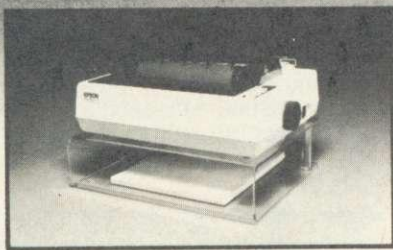

Printer Stand

£12.95 INC. VAT

Carriage & Packing £3.00

A PRINTER STAND

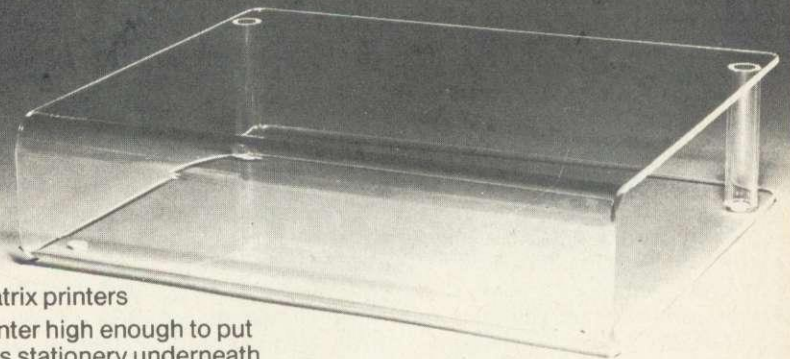

- For dot matrix printers
- Raises printer high enough to put continuous stationery underneath
- Beautifully finished in clear perspex • Viglen quality every time
- Will accept paper up to 12½" wide • Non slip rubber pads

Dimensions: 15" (380mm) wide 12½" (320mm) deep 4" (90mm) high



COME TO VIGLEN FOR A FAST, FRIENDLY, PERSONAL SERVICE

DEALER ENQUIRIES WELCOME

Post to: VIGLEN COMPUTER SUPPLIES, UNIT 7, TRUMPERS WAY, HANWELL, LONDON W7 2QA.

Please send me _____ (qty) PRINTER STANDS at £15.95 each. I enclose Cheque/P.O. for £ _____ made out to

VIGLEN COMPUTER SUPPLIES or debit my ACCESS/BARCLAYCARD No. _____

Name _____   Signature _____

Address _____ AU 9/4

SMART OPERATORS

Barry Pickles clears up the '?' and '!' confusion

124

A LETTER from reader Simon Fernie of London NW2 made me recall my first encounters with Acorn's Basic, and reminded me that among the most confusing things for a newcomer are the indirection operators – query (?) and pling (!). Matters are not helped by their description in the various manuals. '?' is described as 'a binary and unary operator, giving eight-bit indirection'. This kind of computerspeak seems designed to induce panic in the hearts of even experienced hackers but, once you get used to it you begin to appreciate the simple logic. OK, let's try and make some sense of it all.

Microsoft-type Basics have peek and poke. Peek allows you to examine the contents of a byte, while poke allows you to alter the contents. Those machines that think they are clever also have deek and doke, which peek and poke two consecutive bytes. As we shall see, all three Acorn computers go one better but, before reading the next paragraph, I suggest you get hold of something solid!

The '?' and '!' operators of both Atom and BBC Basics are derived from BCPL (see *Acorn User*, April 1983) and are really a very efficient way of indirectly addressing sections of memory. The '?' operator works on single bytes (eight bits), while the '!' operator works on four bytes at a time (four bytes are known as a 'word', hence its definition 'word indirection').

Both '?' and '!' can perform *either* a peek or a poke, depending upon the context. (I did warn you!). If the operators are on the right-hand side of an expression, they are always taken to mean peek. The same applies to conditionals and connectives (IF, AND and OR). On the left-hand side of an expression, the operators are taken to mean poke. Thus, `A=?32768` really means in Microsoft Basic `A=PEEK(32768)` and `?A=32` would be `POKE A,32`, while `?A=?B` translates as `POKE A,(PEEK(B))`. It is absolutely vital that you understand this, or the rest of the article won't make any sense. Read this paragraph again if you're unsure – suck your thumb if it helps!

Right, now we've got the basics out of the way, let's deal with the 'indirection' bit. String variables can be of indeterminate length, so they are normally stored after the program text. To keep track of them, the base address (start

```

5REM: byte indirection
10DIMA32; PRINT#12;@=0; DO
20INPUT"TYPE YOUR NAME AND PRESS return"#A
30IF LENA>32 PRINT"TOO LONG TRY AGAIN"
40UNTIL LENA<=32
49REM: get vector for $A
50C=?#33D*256+?#322
60PRINT""$A IS NOW STORED AND READS:"'$A''
70PRINT"ITS LENGTH IS "LENA" CHARACTERS""
80PRINT"IT IS STORED FROM LOCATION #"&C''
90GOSUBp
100PRINT"STORAGE IS AS FOLLOWS:"
110GOSUBh
120X=0; DO
130PRINT" #"&C+X" "
140IF A?X=32 PRINT#8"<SP> ";GOTOa
150IF A?X=13 PRINT#8"<CR>";GOTOb
160PRINT$(A?X)" "
170aP."A?"X'
179REM: format
180bX=X+1; IF X%10=0 GOSUBp;GOSUBh
190UNTIL A?(X-1)=13
200PRINT"END OF $A - NEXT STRING WOULD BE"
210PRINT"STORED FROM #"&C+X'
220@=B;END
229REM: page & header
230PPRINT"PRESS return TO CONTINUE"
240LIST#FFE3; PRINT#12; RETURN
250hPRINT"location character element";RETURN
    
```

Listing 1. Provides a graphic representation of string storage

of the actual stored string is allocated to the string pointer storage area, in block-zero memory. Thus, for a variable called \$A, the A actually holds a pointer to where the string really is – this is known as 'vectoring'. A string is a series of characters ending in a carriage return (#0D) so, to find \$A, the Atom looks up the vector and then prints everything from that address as an ASCII character, until it finds a carriage return.

Let's look at a typical example. Imagine we have stored at #3000 a string, reading 'THIS IS AN EXAMPLE'. Now, if you used the ASCII dump program given in June's Atom Forum to look at that part of the memory, you would see the following display:

```

3000: THIS IS
3008: AN EXAMP
3010: LE OD.....
    
```

If you wanted to find the Nth character of this string, the formula would be `?#(3000+N-1)` – the first character would be `?#(3000+0)`, the fourth character `?#(3000+3)`, and so on. This translates in Atom or BBC Basic to `N?#3000` or `#3000?N` – it doesn't matter which way round you put it. Likewise, if you refer to \$A instead of `##3000`, you would say `A?N` (or `N?A`). This is known as 'string indirection'.

'Byte indirection' is really the same thing, but works on an array of numbers, whose values are less than 256 – see page 53 of the Atom manual – and these are commonly used for simple look-up tables.

To help you understand further, listing 1 provides a graphic representation of string storage. Once you understand indirection, the Atom's string manipulation routines become much clearer and you'll begin to appreciate why I believe them to represent a more logical approach than Microsoft's and BBC Basic's `LEFT$`, `RIGHT$` and `MID$-A?N` is much simpler to understand than `MID$(A$,N,1)`.

Arrays of strings are handled in much the same way, but here the base address of the string is held in the array *element*. It is placed there using a 'dummy' string variable and assigning this with a statement of the form: `AA(N)=A`, where AA is the array, N the element and A the dummy variable. Once assigned, you can forget the dummy and use indirection on the array element as if it were a normal string (ie, `AA(N)`) – see page 62 of the Atom manual for an example. Once you've mastered this, string sorts become much less of a problem, since you treat them as numeric sorts, using

page 130 ►

SIMPLE
TO USE



The only ROM Cartridge System that does not overload your pocket or your BBC Micro

Why risk damage to your BBC micro every time you want to change ROM's? Instead, store your growing collection of ROM's in professionally-made protective cartridges!

- Insert and remove Wordwise, View, Disc Doctor etc. at will from your micro in absolute safety - no wear or damage to pins to your ROM's.
- Low, low power consumption unlike other systems.
- Saves on memory.
- Price for complete kit including one cartridge only **£19.95 inc. VAT.**
- Extra ROM cartridges £27.75 for five, £49.50 for ten cartridges and single cartridges £6.95 each.

Dealer enquiries welcome.

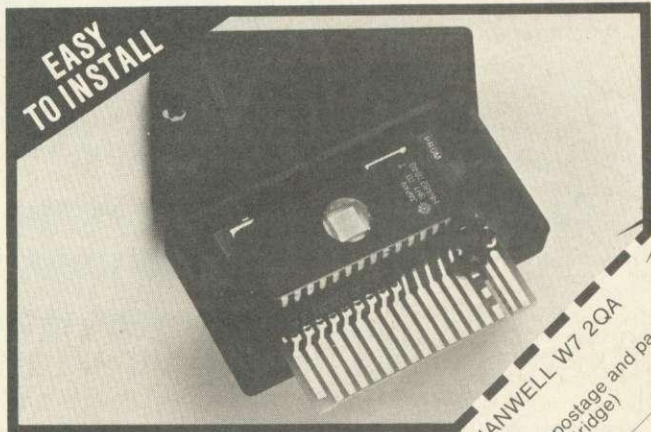

EASY
TO INSTALL

Viglen

COMPUTER SUPPLIES

Unit 7 Trumplers Way
Hanwell W7 2QA
Tel: (01) 843 9903

Post to: VIGLEN COMPUTER SUPPLIES UNIT 7, TRUMPERS WAY, HANWELL W7 2QA
Telephone: 01-843-9903. Personal Callers Welcome.
I enclose Cheque/P.O. for £
I prefer to pay ACCESS/BARCLAYCARD (Delete whichever is not applicable)

Card No.

Signature

Name

Address

Please add £2.00 for postage and packing.
(50p only for single cartridge)
Kits
Cartridges

Credit cards valid only if signed by card holder. Address below must be the same as card holder.

Cheques payable to
Viglen Computer Supplies

AU9/5

We're on the MOVE

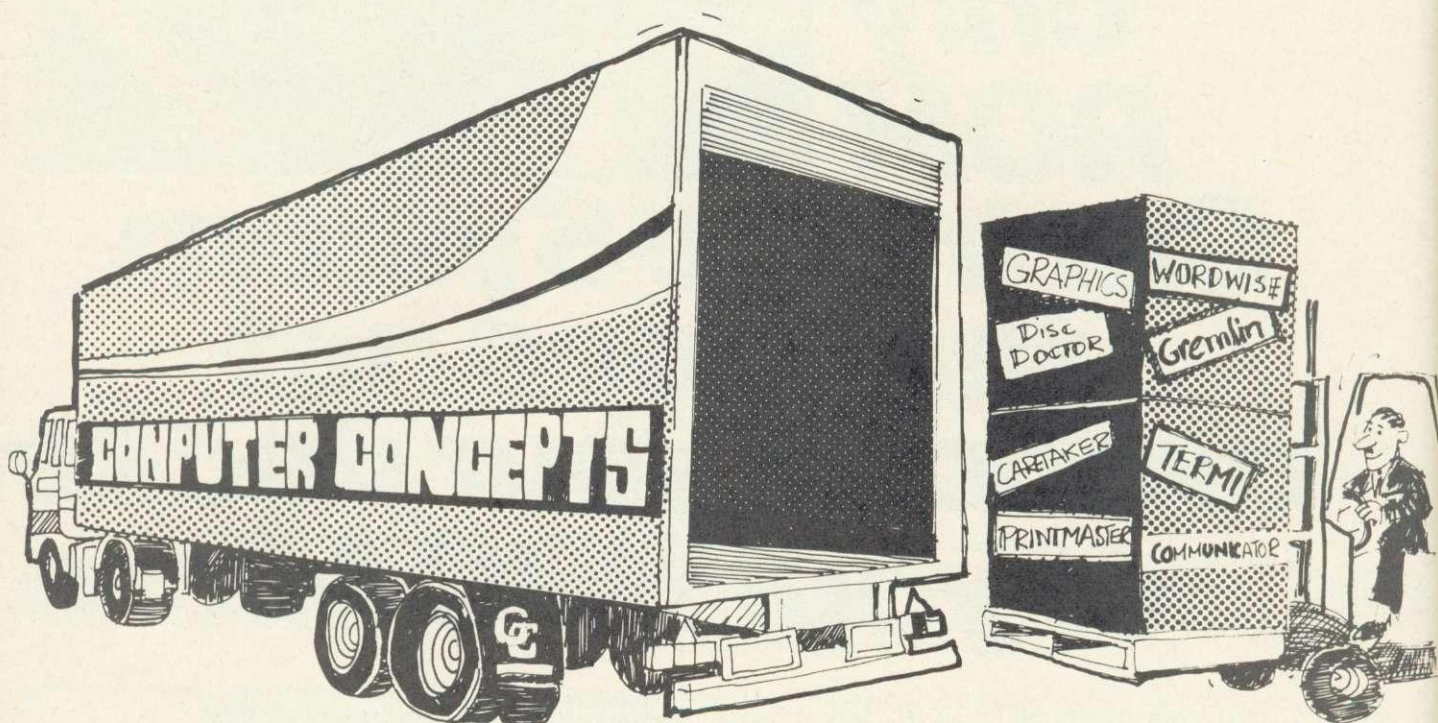

To Gaddesden Place, Hemel Hempstead, Herts HP2 6EX
Telephone: (0442) 63933
On the 1st August 1984

*Computer Concepts are expanding and require machine code programmers
with experience of Z80/6502 processors.
For further details of vacancies write to:*

**The Manager
Computer Concepts
Gaddesden Place
Hemel Hempstead
HERTS HP2 6EX**

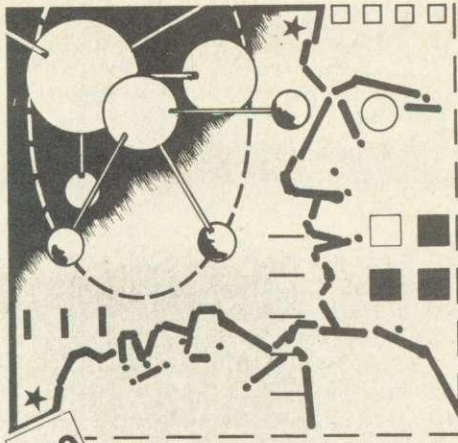

Base-2 text processor

AS PROMISED in last month's Atom Forum, here are screen dump routines for the Seikosha and Centronics 737/739 printers (listings 1 and 2).

```

995REM: SCREEN DUMP FOR
996REM: CENTRONICS 737/9
997REM: by Barry Pickles
998REM: (c)ACORN USER 1984
999
1000dP.$21$2$27$37$48'
1010 A=160;S=32
1020 F.N=0 TO 1740 S.192
1030 F.J=0 TO 31;M=128
1040 F.K=0 TO 7
1050 X=#8000+N+J;D=32;P=1
1060 F.L=0 TO A S.S
1070 IF(X?L&M); D=D+P
1080 P=P+P;N.L
1090 P.$D;M=M/2;N.K
1100 N.J;P.';N.N
1110 P.$27$19$3$6;R.
    
```

Listing 1. Centronics 737/9 screen dump

While we are on the subject of printers, David Legg of South Godstone has supplied a simple but effective text processor (listing 3, yellow page xvi), which earns him £20. It was written for the Base-2 printer, and lines 136 and 137 select double and single spacing respectively. Likewise, line 345 selects elongated print. The appropriate code sequences for your printer should replace those in the above lines. Instructions are simple:

On running the program the menu is printed. New text is entered by typing 1. The computer will then ask for the required line length ('Enter number of characters per line'). The next question is Draft? This is specific for the Base-2 printer and so can be omitted. (On the Base-2 it will double-space.)

When all the questions have been answered an INPUT question mark will appear. Up to 64 characters may be entered. The program consolidates the text printing. Pressing RETURN enters the string and offers a new question mark. When a new line or paragraph is required type in ↑ (this will be omitted during printing). Note that lines 285 and 345 are specific for Base-2 printers. On entering ↑ elongated letters are printed. To return to the menu enter MENU on a new line then press RETURN.

Barry Pickles starts you off with printer dumps and readers' gems include routines for single stepping and a FILL command

LIST TEXT - The text is listed line by line by typing RETURN.

LIST TEXT + NO'S - The text is again listed by typing RETURN but also allows for alteration. Each line is printed with its line number. By typing A at the first query and pressing RETURN a new altered line can be entered. The new line is then printed out, so allowing two bites of the cherry.

The remaining functions are self-explanatory. On PRINT TEXT there is a delay while the text is being justified.

When loading from tape the normal requirement of waiting for the 'Leader' must take place.

Single-stepping

with VIA fitted

THIS submission from Andrew Luck, who wins £10, describes a means of single-stepping through a machine code program on an Atom equipped with a VIA (listing 4, page xvi). Link 2 must be fitted to enable interrupts from the VIA.

Timer 1 of the VIA is used in the one-shot mode to generate an interrupt after a set length of time. As the 6502

finishes executing the current instruction before responding to the interrupt, the timer must be set to interrupt the program during the next instruction. This causes the 6502 to branch to the interrupt service routine to display the contents of the registers. The target program must not contain SEI or BRK instructions as these would disable the single-step routine.

The set-up routine at KK0 is called instead of the target routine and this sets up the timer and clears the interrupt disable flag before executing an indirect jump to the target program, line 520. The IRQ vector at #204, #205 is set to point at the single step interrupt handler. When an interrupt occurs, the Atom stacks the accumulator before jumping to the interrupt routine. The interrupt routine displays the program counter, the contents of the status register and the A, X and Y registers. After waiting for a keypress, the timer is set running again and a return is made

Invented a routine or discovered a hardware modification for the Atom? Here's a chance to show your originality and win some cash. Send your idea to: Atom Forum, Acorn User, Redwood Publishing, 68 Long Acre, London WC2 9JH.

```

5REM: SCREEN DUMP FOR
6REM: SEIKOSHA PRINTERS
7REM: by Barry Pickles
8REM: (c) ACORN USER '84
10 DIM LL10;Z=#FEFB
20 IN."ASSEMBLE FROM"Q
30 F.N=0 TO 10;LLN=Q;N.
40 P.$21;F.N=0 TO 1
50 P=Q;[
60:LL0 LDA@2;JSR Z;LDA@8
70 JSR Z;LDA@7F
80 STA#8A;STA#81
90 LDA@#E0;STA#80
100 LDA@0;STA#8D
110 LDX@1;STX#8B
120:LL1 LDY@0;STY#89
130 LDA@27;JSR Z
140 LDA@16;JSR Z;LDA@0
150 JSR Z;LDA@#70;JSRZ
160 LDA#B002;ORA@8
170 STA#B002;LDA@#7F
180 AND#8A;JSR#FF10
190:LL2 LDX@7;CLC
200:LL3 LDA(#80),Y
210 STA#81,X;TYA
220 ADC@32;TAY;DEX
230 BNE LL3;LDY@8
240:LL4 LDX@7
250:LL5 ASL#81,X;RORA;DEX
260 BNE LL5;RORA;ORA#8B
270 AND#8A;JSR#FF10;DEY
280 BNE LL4;INC#89
290 LDY#89;CPY@32
300 BNE LL2;LDA@0
310 STA#8B;LDA@#7F
320 AND#8A;JSR Z
330 LDA#B002;AND@#F7
340 STA#B002;LDA@13
350 JSR Z;LDA@224;CLC
360 ADC#80;STA#80;LDA@0
370 ADC#81;STA#81
380 INC#8D;LDA#8D
390 CMP@27;BMI LL6
400 BNE LL7
410 LDA@63;STA#8A
420 LDA@32;STA#8B
430:LL6 JMP LL1
440:LL7 LDA@15;JSR Z
450 LDA@3;JSR Z;RTS;];N.
460@=0;P."*SAVE ""SCRNDUMP""
470P.&Q" "&P'
480P."LINK #"&LL0" TO USE""
490END
    
```

Listing 2. Seikosha printers screen dump

Draw with the BBC micro and show the true potential of your machine

Fill shapes in one of 23 colours (Mode I)
 Draw points, lines, rectangles ellipses and circles
 Smooth curves
 Wire frame diagrams
 Hidden line removal
 Draw in perspective
 Measure scaled distances
 Ekta sketch lines, Half tone facility
 Mirror images
 Repeat images, SS, enlarged, reduced, stretched
 Actual colour displayed
 Store up to 10 ellipses or circles in memory
 Redraw any one of these at cursor position
 Change any actual colour for one of 8 others
 Clear screen, load screen, save screen
 Print characters or numbers at any pixel point
 Error messages for incorrect input
 Fully comprehensive manual

356 496 • □ •••

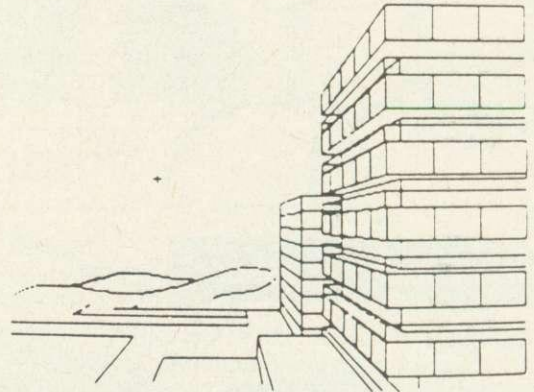

This programme has been purpose designed by professional Graphic Designers for simplicity and ease of use, and is undoubtedly the most versatile drawing programme on the market at this time. There is no need to input any numerical data, as all judgements are made visually. The BBC Micro is the finest drawing machine in its price range. Find out what it can do.

The A. B. Designs drawing programme costs only £36 for over 70 functions (model B). New AB2 Program, available on disc (price £61) and cassette (price £51). When ordering send Cheque/PO and VAT at 15%. Please include phone no. with all correspondence. For further information send SAE and phone no. to A. B. Designs, 81 Sutton Common Road, Sutton, Surrey, 01.644 6643 (closed all day Thursday).



'ROM/RAM EXPANSION BOARD



£54.95

THE ULTIMATE ROM/RAM EXPANSION SYSTEM FOR THE BBC MICRO

- ★ 12 extra ROM sockets complement those already provided by the micro to allow up to 256K ROM space.
- ★ Four of these sockets can support either ROM or Static RAM (up to 16K maximum RAM).
- ★ The Model 2 board allows switching between multiples of 2K, 4K, 8K or 16K ROM/RAM.
- ★ Compatible with most other add-ons including TORCH, 2nd processors.
- ★ Additional features include the ability to transfer paged firmware to disc, and then load back into sideways RAM for future use - giving you no limit to the number of effective ROMs accessible!
- ★ NO soldering, plug-in design.
- ★ Fits easily inside BBC case.
- ★ Plugs into CPU socket via short flexible connector.
- ★ Improved plug design allows the Model 2 board to connect securely to any type of BBC CPU socket with no harm to micro or board.
- ★ Board is held in place by sturdy supports.
- ★ Full instructions provided.

All our prices are inclusive of VAT unless specified otherwise.
Postage and Packing: Please add £1 for small items (ROM/RAM Boards, software, etc.)
 £2.50 for medium items (disc drives, BBC Computers).
 £10 for larger items (monitors, printers, etc.).
 (Postal rates apply within U.K. only. Please telephone for export rates)
 Access/Barclaycard Telephone orders welcome.

SIR BUSINESS & COMMUNICATIONS

We announce our appointment as TORCH UNICORN Dealers, at a time when Acorn & TORCH are joining forces. . .

THE TORCH UNICORN RANGE:

CP/M compatible extensions to the BBC

Microcomputer System:

ZEP 100: Z80 2nd processor card; 64K RAM; FREE SOFTWARE (see below) £299 + VAT

ZDP 240: Z80 Disc Pack comprising ZEP 100; 2 x 400K floppy disc drive; FREE SOFTWARE (see below) £799 including VAT.

HDP 240: As ZDP 240 but with one 400K drive replaced by a 20MB Winchester Hard Disc unit . . . around £1,995 + VAT.

HDP 68K: As HDP 240 but with twin (Z80B and 68000) "second" processors; provides an extra 256K RAM! . . . around £2,495 + VAT.

THE UNICORN: Top of the range. The TORCH UNICORN comprises HDP 68K plus FULL UNIX III Operating System . . . around £2,895 + VAT.

TORCH C-500: Complete self-contained unit (NO BBC MICRO REQUIRED) comprising BBC Micro system, ZDP, hi-res colour monitor & British Telecom-approved communications card. Price available on application.

FREE SOFTWARE: BBC BASIC (Z80) [allowing almost 48K User Memory!]; 'Perfect' Writer (word processor); 'Perfect' Calc (spreadsheet); 'Perfect' Filer (database filing system); Complete software package normally worth about £1,000!!

BBC MICROCOMPUTER

BBC Model A £299.00

BBC Model B £399.00

BBC Model BD £469.00

DISC DRIVES

Single 100K NOW £139.00

Dual 100K NOW £279.00

Dual 400K (40/80T switchable) NOW ONLY £399.00

PRINTERS

Dot Matrix:

Shinwa CP-80 £219.00

Epson RX-80 F/T £275.00

Epson FX-80 £389.00

Daisywheel:

Juki 6100 £389.00

MONITORS

Sanyo B/G £85.00

Microvitec RGB £219.00

SOFTWARE

We have a diverse range of titles currently in stock including ROM based programs such as VIEW

(£59.80), (NEW 2.1 VERSION), Computer Concepts' GRAPHICS ROM (£32.20), WORDWISE (£39.95) and DISC DOCTOR (£29.95).

Please telephone for full details of software range and current stock.

ACORN BBC SECOND PROCESSORS

6502 2nd Processor £199.00 Z80 2nd Processor £299.00

SIR COMPUTERS LTD, 91 Whitchurch Road, Cardiff CF4 3JP. Telephone: Cardiff (0222) 621813

to the target program.

Lines 70-160 set up the display, lines 180-200 display PC, lines 210-260 display P, and lines 270-290 display A, X and Y.

If the machine code is relocated, the address in line 40 of part 2 should be set to the end address of the m/c + 1. The address in line 50 should be set to the value of KK0.

Part 1 should be entered and run. Part 2 should then be entered in any convenient text space except #2800 and then run. The target routine should already be resident.

£20 Command for clearing, filling and inverting

The graphics commands in AtomBasic are fairly comprehensive, says Mark Bryson of Yealand Redmayne, Lancashire, in that they allow the use of absolute or relative plotting co-ordinates with clear, set or invert options in both point and line drawing, as well as move operations. Yet one facility often found on other machines that is not provided is the FILL 'area' command.

As listed the routine (listing 5) works properly only in the highest resolution graphics mode (CLEAR4), the reason

being that enabling it to take account of the different resolutions makes the code significantly longer and more complicated, and anyway AtomBasic is usually fast enough at low resolution.

Information on how to use the point-plotting routine in ROM is given in the Atom manual (page 88). This routine plots points one at a time - although it does so rather quickly! The 'fill' routine works by calculating the changes to eight points (pixels) at once and then it uses part of the point plotting routine in ROM to actually put them on the screen. Incidentally, no screen interference will be seen during a 'fill', which is not the case when filling using plot or draw.

To make the programming easier Mark decided to dedicate certain variables to be used by the routine, rather than allow any to be used. Other variables could be used providing you alter the assembler program accordingly; in fact, any free bytes could be used, although this may mean you will find it less simple to assign values to the variables from Basic. Also if you use free locations in zero page RAM the relative jumps in the assembler will need to be reduced in size accordingly (or the code 'padded out' with NOPs).

The routine allows clearing, filling and inverting of all points in any rectangle, ranging in size from a single

point (ie one pixel) to the whole screen. It uses but does not corrupt the least significant bytes of the variables L, T, R, B and I. These define the X and Y co-ordinates of the Left, Top (L, T) and Right, Bottom (R, B) corners of the rectangle to be filled, while I determines the effect produced.

There are six possibilities. Assigning to I a value of zero (or 3 to 127 inclusive) means that all points in the specified rectangle will be cleared, 1 sets and 2 inverts all points. By ORing these values of 1 with 128 a sort of half-intensity fill is possible. For example, I = 2 OR 128 (equivalent to I = 130) gives a half-intensity inversion of the defined rectangle. The half-intensity options work by affecting alternate points only, the remaining ones being left unchanged.

The code produced is less than 250 bytes long, which means that it fits neatly into the floating-point workspace at #2800. However it is re-locatable (even when assembled) as it contains no 'jump' instructions other than to an address in ROM, and so can be *LOADed to any position in RAM.

Two demonstration programs are included. These are called by typing 6.1000 or 6.2000. Finally, the routine included delays to avoid screen noise. If

129

Listing 5. Mark Bryson's FILL routine

```

2800 38 AD 33 3 ED 2D 3 B0 135LDY@0;STY@AE;STY@AF
2808 1 60 AD 35 3 ED 23 3 140\calc R,B byte
2810 90 F7 A0 0 84 AE 84 AF 145LDA@191;SBC@323;BCCP-20
2818 A9 BF ED 23 3 90 EA A2 150LDX@3
2820 3 4A 66 AF CA D0 FA 9 155LSRA;ROR@AE;DEX;BNEP-4
2828 80 85 A9 AD 33 3 48 4A 160DRA@E80;STAE@9 high byte
2830 4A 4A 5 AF 85 A8 68 29 165LDA@333;PHA
2838 7 AA E8 98 38 6A CA D0 170LSRA;LSRA;LSRA
2840 FB 85 AD 38 A9 BF ED 35 175ORA@AF;STAE@8 low byte
2848 3 B0 1 98 A2 3 4A 66 180PLA;AND@7;TAX;INX;TYA
2850 AE CA D0 FA 9 80 85 AB 185SEC;RORA;DEX;BNEP-3
2858 AD 2D 3 48 4A 4A 5 190STAE@D
2860 AE 85 AA 68 29 7 AA E8 195\calc L,T byte
2868 98 38 6A CA D0 FB A 49 200SEC
2870 FF 85 AC 38 A5 A8 E5 AA 205LDA@191;SBC@335;BCSP+3
2878 85 AE A5 A9 E5 AB A2 5 210TYA;LDX@3
2880 4A 66 AE CA D0 FA A6 AE 215LSRA;ROR@AE;DEX;BNEP-4
2888 E8 86 AE 86 AF AD 2A 3 220ORA@E80;STAE@B high byte
2890 29 7F 85 5E 98 2C 2A 3 225LDA@32D;PHA
2898 10 2 9 AA 49 FF 48 A5 230LSRA;LSRA;LSRA
28A0 AA 45 A8 29 1F D0 8 A5 235ORA@EAE;STAE@A low byte
28A8 AC 25 AD 85 AC 84 A9 A5 240PLA;AND@7;TAX;INX;TYA
28B0 AA 85 5F A5 AE 85 60 18 245SEC;RORA;DEX;BNEP-3;ASLA
28B8 68 10 1 38 2A 48 2C 2 250DRA@255;STAE@C
28C0 B0 30 FB 25 AC 20 20 F7 255\calc no horiz. lines
28C8 18 A5 5F 69 20 85 5F A5 260SEC
28D0 60 69 0 85 60 C6 AE D0 265LDA@EAE;SBC@EAA;STAE@E
28D8 DF A5 A9 D0 2 68 60 A9 270LDA@EA9;SBC@EAB;LDX@5
28E0 FF 85 AC E6 AA A5 AF 85 275LSRA;ROR@AE;DEX;BNEP-4
28E8 AE 29 1 F0 B2 18 68 10 280LDX@EAE;INX;STX@AE;STX@AF
28F0 1 38 2A 48 D0 A9 0 0 285LDA@32A;AND@127;STAE@E
100P=#2800 290TYA;BIT@32A;BPLP+4
105P.#21;C 295ORA@170;DRA@255;PHA
110\check R>=L and T>=B 300\begin new column
115SEC 305LDA@EAA;DRA@EAB;AND@31
120LDA@333;SBC@32D;BCSP+3;RTS 310BNEP+10
125LDA@335;SBC@323;BCCP-7 315LDA@EAC;AND@EAD;STAE@C
130\clear masks 320STY@A9 finish flag
325LDA@EAA;STAE@F
330LDA@EAB;STAE@0
335\plot one byte
340CLC;PLA;BPLP+3;SEC
345ROLA;PHA
350BIT@B002;BMIP-3
355AND@EAC;JSR@F720;CLC
360LDA@E5F;ADDC@32;STAE@F
365LDA@E60;ADDC@0;STAE@0
370DEC@EAE;BNEP-31
375LDA@EA9;BNEP+4;PLA;RTS
380LDA@255;STAE@C;INC@EAA
385LDA@EAF;STAE@E;AND@1
390BEQP-76
395CLC;PLA;BPLP+3;SEC
400ROLA;PHA;
405BNEP-85
410J
415P.#6
999REM random rectangles
1000K=0
1010DO CLEAR4
1020 K=K:128
1030 FOR J=0 TO 99
1040 I=A.R./%3+K
1050 L=A.R./%128
1060 R=A.R./%128+L
1070 B=A.R./%96
1080 T=A.R./%96+B
1090 LINK#2800
1100 NEXT J
1110UNTIL 0
1120END
1999REM animation
2000CLEAR4;B=150;T=B+8;I=2
2010DO L=L-2;R=L+8
2030 LINK#2800;LINK#2800
2040UNTIL 0
2050END

```



```

10REM      A C O R N
20REM      MADE IN HOLLAND BY:
30REM      ANDRE DE BRUIN
40REM
50 DIMAA100, BB100, CC100, DD100
60 CLEAR4
70a
80 FOR O= 0 TO 3
90 K=0;L=125
100 IF0=0;X=75;S=175;%S=(2*PI/13);R=6;V=4;
    F=0;H=50
110 IF0=1;X=65;S=185;%S=(2*PI/15);R=5;V=4;
    F=1;H=60
120 IF0=2;X=120 ;S=134;%S=1;R=2;V=2;F=0;H=0
130 IF 0=3;X=0;S=14;%S=(2*PI)/7;R=5;V=1;F=0;
    H=0;L=188
140 FOR J = 1 TO R
150 B=S-X;GOSUB c; X=X+ %(H/R);S=S- %(H/R)
160 NEXT J
170 NEXT O
180 X=0;Y=0
190END
200c
210 IF0=0;Y= %(-0.04*((X-125)*(X-125)) +190 )
220 IF0=1;Y=%(( 4/360)*((X-125)*(X-125)))+40
230 IF0=2;IFJ=1;Y=40
240 IF0=2;IFJ=2;Y=20
250 IF0=3;Y=%((-10/4115)*((L-125)*(L-125))+19);
    L=L-20;S=S-1
260 T=((B/2)+L);U=Y; %R=0;Z=0
270o
280 P=%( COS%R*(B/2)+L); Q=%(SIN%R*((B/2)/V)+Y)
290 MOVE T,U;PLOT5,P,Q;T=P;U=Q
300 IF K%2 =0 THEN AAZ=P;BBZ=Q
310 IF K%2 <>0 THEN CCZ=P;DDZ=Q
320 IFK=0 THEN GOTO r
330 IF 0=1 GOSUB n
340 MOVE AAZ,BBZ;PLOT5,CCZ,DDZ
350r %R=%R+%S;Z=Z+1
360 FIF %R<(2*PI+0.1);GOTO o
370 AAZ=AA1;BBZ=BB1;CCZ=CC1;DDZ=DD1;K=K+1
380RETURN
390n
400 IFK%2=0;MOVECCZ,DDZ;PLOT5,AAZ,BBZ;PLOT5,
    CC(Z+1),DD(Z+1)
410 IFK%2<>0;MOVEAAZ,BBZ;PLOT5,CCZ,DDZ;PLOT5,
    AA(Z+1),BB(Z+1)
420RETURN
    
```

Listing 6. Wire-frame acorn, wrought by André de Bruin of the Netherlands

this doesn't bother you, you can speed it up considerably by rewriting two lines as follows:

```

105P.$21;[;LDA#334;STA #80
350LDY #80;DEX;BNE P-1
    
```

Mark's reward for Atomfill is £20.

£5

Dutch acorn

THE ACORN graphics routine (listing 6) is courtesy of André de Bruin of the Netherlands. It would convert easily to the Beeb if the X and Y co-ordinates are scaled up.

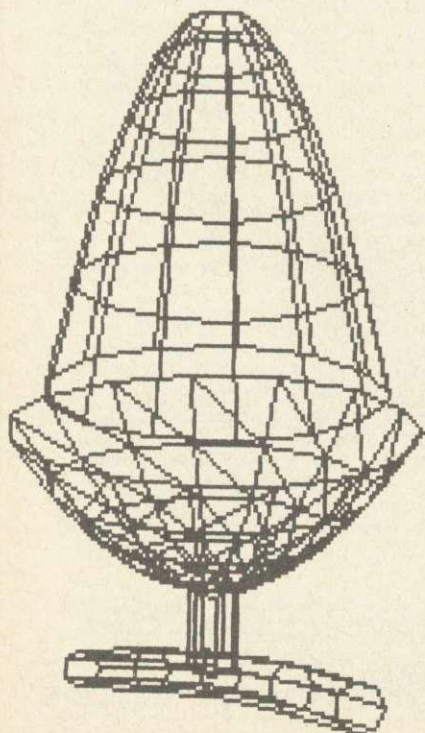

SMART OPERATORS

```

5REM: word indirection
10 PRINT$12; @=1; INPUT"HEX NUMBER "A
20 PRINT"WORD IS DESIGNATED AS !A"
30 PRINT"!A=#"&A
40 PRINT"IT IS STORED AS FOLLOWS:"
50 FOR N=1 TO 4
60 PRINT"STEP "N" "; B=A#&FF
70 A=((A#&FFFFFF00)/256#&FFFFFF)
80 PRINT"A?"(N-1)"="#&B" A=#"&A
90 NEXT;END
    
```

Listing 2. How the interpreter handles a sequence of numbers

◀ page 124

the ASCII value of the Nth character (obtained by for example A?N) – see June's *Acorn User* for some Basic sorting techniques.

Now let's return to simple numeric arrays and let's suppose that you want to store four (or more) consecutive numbers, from #3000 onwards. You could write:

```

A=#3000;A?0=255;A?1=254;
A?2=253;A?3=252
    
```

That's not only a lot of typing, it uses 45 bytes of program space (including line numbers and delimiters). If we convert each number to hex format, we can now write:

```

A=#3000;A!0=#FCFDFF
    
```

This only uses 22 bytes and, what's more, it executes faster than the first method (almost four times faster). The more observant among you will have noticed that, in the conversion, the order of the numbers has become reversed. You must remember this when using word indirection. To see

why this should be, listing 2 emulates the way the interpreter handles this statement. Word indirection is a fast and compact way of setting up long tables (eg for character generation). To illustrate its usefulness, try the following on the Atom, which clears a mode 4 screen to white:

```

F.N=#8000 TO #9800 S.4; !N = -1; N.
    
```

Then compare the speed with a similar routine, using the ? operator:

```

F.N=#8000 TO #9800; ?N=#FF; N.
    
```

You may have noticed that, instead of writing N!0 and N?0, we used !A and ?A. The Atom assumes the zero if no other subscript is given. You should also note that writing values using '!' always works on four bytes. If you use less, eg, !A=#FF3B, Atom will assume leading zeros and store it as 3BFF0000.

I hope I've now sorted out some of the confusion. These two operators are really powerful, once you get used to them, and Acorn must obviously agree, since it has been carried over into BBC Basic.

TECHNICAL EDITOR £8000 to £14000

BEEBUG Publications Ltd. require a **Technical Editor** to take an important and responsible role in a team producing two computer magazines, for the Acorn Electron and BBC microcomputers. Previous experience with either of these machines is highly desirable together with the ability to write in a clear and interesting style.

The successful candidate will probably have a number of years experience either in microcomputing or in journalism. If you think that you have the right skills and experience to undertake this demanding and interesting job then write to:

BEEBUG Publications Ltd., Personnel Department, P.O. BOX 50, St. Albans, Herts.
enclosing a curriculum vitae, and samples of your own work.

StarBASE... a new database

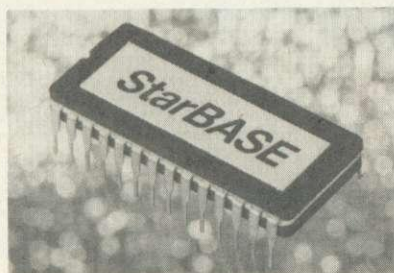

StarBASE... for the BBC

Will now mail merge with Wordwise or View

STOCK SUBJECT TO PRIOR SALE

Local authority enquiries welcome.
Prices correct at time of going to press.



GCC (Cambridge) Limited
66 High Street, Sawston, Cambridge CB2 4BG
Telephone: Cambridge (0223) 835330/834641
Telex: 81594 SAWCOM

The StarBASE professional database management system consists of a 16K ROM, 51K of extension and applications software on disc and a comprehensive manual. StarBASE was designed by a chartered electronics and software engineer to meet a defined need for a high specification, disc-based random access system. The database program and extension software is "Menu Driven", particularly user-friendly, quick to use, but extremely powerful and totally flexible. It is absolutely ideal for use in schools, clubs, colleges, small businesses and in the home.

- Menu Driven throughout
- True random access – will locate a single record in under 2 seconds typically.
- File size is the capacity of a single disc (double sided if applicable) – minus 5K.
- Maximum number of fields 69.
- Maximum number of characters in a field 255 (subject to an overall maximum of 920 in a record).
- Up to 4096 records.
- Records are displayed and input on a "Card Screen" principle. Layout of fields and headings are built entirely by the user by "Painting" on the screen (colour can be used).
- Direct and rapid entry of data into all or selected fields.
- Search criteria include =, <, >, <., >., and a wildcard "anywhere in the field".
- Unlimited and rapid sequential searching and selecting.
- All or selected records can be sorted to a depth of 5 fields, each in ascending or descending order, using the super-fast Shell-Metzner routine.
- Instant print or display review of file, giving breakdown of record size, number of records possible and space used, etc.
- Address and label printing (up to 8 across the page).
- Selected whole or part field-content printing, with left and right justification, tabbing, and embedded printer control codes possible. Can be mixed with text for invoices and form letters etc.
- Can be configured for any printer (including £ character definition).
- Continuous or paged printout with page heading and pause at each page end, with "New Page" prompt.
- Repeat printing for multiple copies.
- Percentage and arithmetic operations to specified decimal placing.
- Field statistics giving totals, mean and standard deviation, variance and squares.
- Optional password lock.
- Fully documented routines (in Basic) which can be spooled onto user-written tailor-made file management and interrogation programs.

StarBASE meets and even exceeds professional standards found on large installations. It is unique in speed, flexibility and ease of use.

Price? Only £69.00 inc VAT (plus £1.50 p & p).

CHASE DATA

PRICES SENSATION

Canon 110: Case/Cables all INCL £99

Canon 220: 400K (40/80 switching)

Case/Cables all INCL £169

N.B. These are state of the Art Disc Drives; Direct Drive
40 track 6mms Access/80 track 3ms Access.

DFS Kits available
ex stock
all inclusive price £109

SLIM CANON DISC DRIVES:

MODEL:	SPECIFICATION OF EACH DRIVE
110	S/SIDED 40 TRACK 100K
210	D/SIDED 40 TRACK 200K
220	D/SIDED 80 TRACK 400K (40/80 TRACK SWITCHING)

■ All **CANON** 40/80 switchable disc drives feature an on-board dual-colour LED on the front panel to show track mode selected. This is coupled with our own unique two-stage illumination, to give a clear operating status, as follows:

40 TRACK MODE: _____ LED GREEN

80 TRACK MODE: _____ LED RED

POWER ON: _____ HALF-ILLUMINATION (GREEN OR RED)

DRIVE SELECTED _____ FULL-ILLUMINATION (GREEN OR RED)

■ Super-slim **CANON** drives, models 211 and 221 and the **SANYO** model 548S, are available with their own **custom-built secondary switching power supply**. This is safe, low in heat generation and excellent value for money.

■ The **SANYO** disc drive is our latest acquisition in quality Japanese products. This is a "half-height" unit of standard dimensions.

LTD DISC DRIVES

**FOR THE
BBC
MICRO**

SLIM SANYO DISC DRIVES:

MODEL: SPECIFICATION OF EACH DRIVE
548S S/SIDED 40 TRACK 100K

SUPER-SLIM CANON DISC DRIVES:

MODEL: SPECIFICATION OF EACH DRIVE
211 D/SIDED 40 TRACK 200K
221 D/SIDED 80 TRACK 400K
(40/80 TRACK SWITCHING)

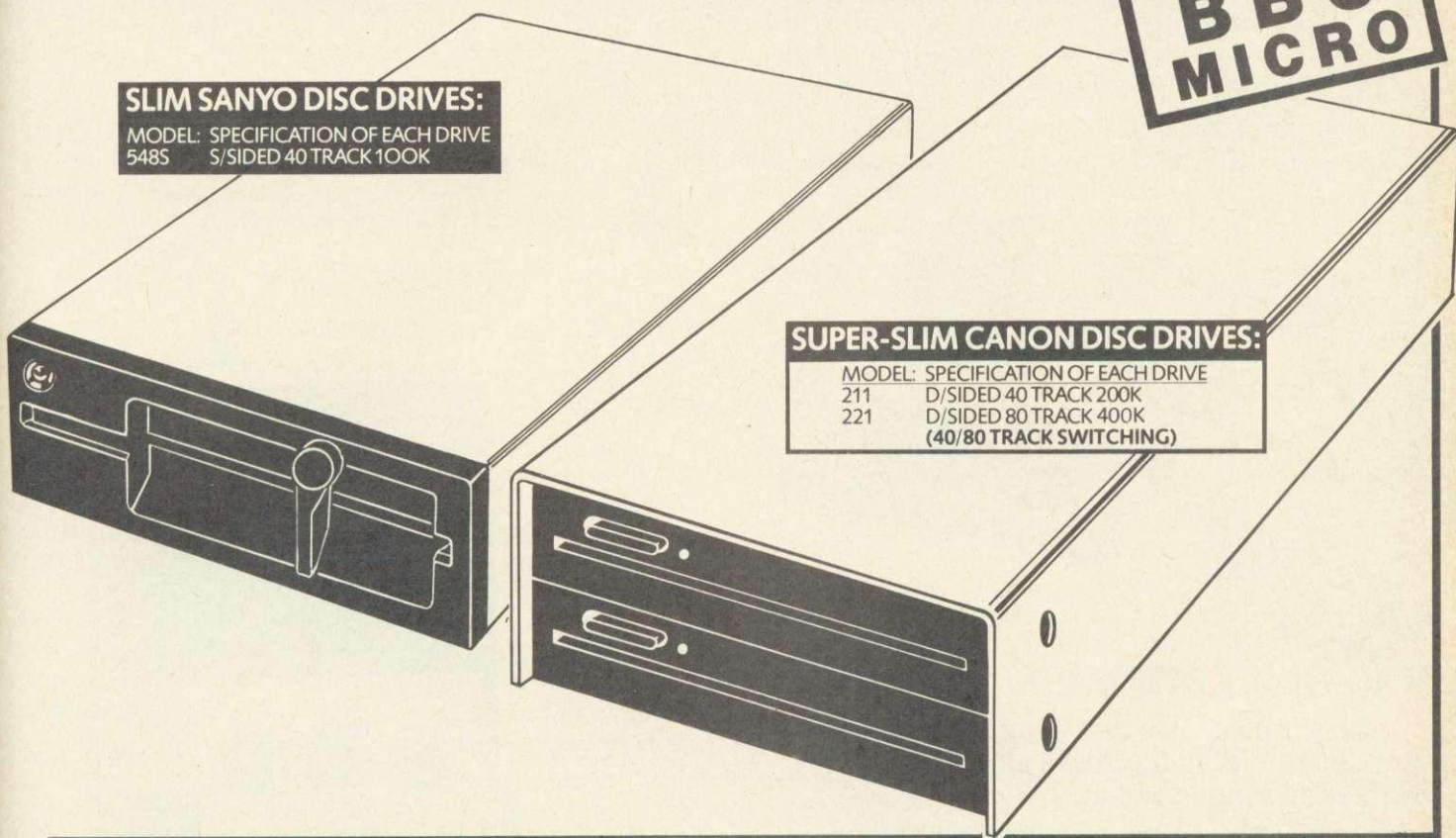

All inclusive price list:

This means: disc drive + case + all power & data cables + U.K. carriage + utilities disc & manual + V.A.T.

	CANON					SANYO
MODEL:	110	210	220	211	221	548S
Formatted Capacity per drive on BBC Micro:	100k	200k	400k	200k	400k	100k
Single Drive & Case:	£99	£139	£169	£179	£236	£154
Single Drive & Case/P. Supply:	£124	£164	£194	£209	£266	£184
Dual Drive & Case:	£204	£274	£314	£329	£437	£284
Dual Drive & Case/P. Supply:	£229	£299	£339	£359	£467	£314

Support:

Warranty: All disc drives sold by Chase Data Ltd. come with a full one-year warranty on parts & labour.

Non-warranty service: As THE experts in our field we can offer service on most makes of floppy disc drive.

Recalibration & Alignment ... £25 per unit inc. VAT. (parts extra). Phone for details: (Tel: 0784 38487)

Payment



By Post: Send your remittance (cheques only please) with your order to:

CHASE DATA LTD

P.O. Box 6, Woking, Surrey, GU21 4PB.

By Phone:  (Tel: 0784 38487).

CLEARLY HE HAD ONLY ONE KEYBOARD IN MIND WHEN HE DESIGNED THE HUMAN HAND

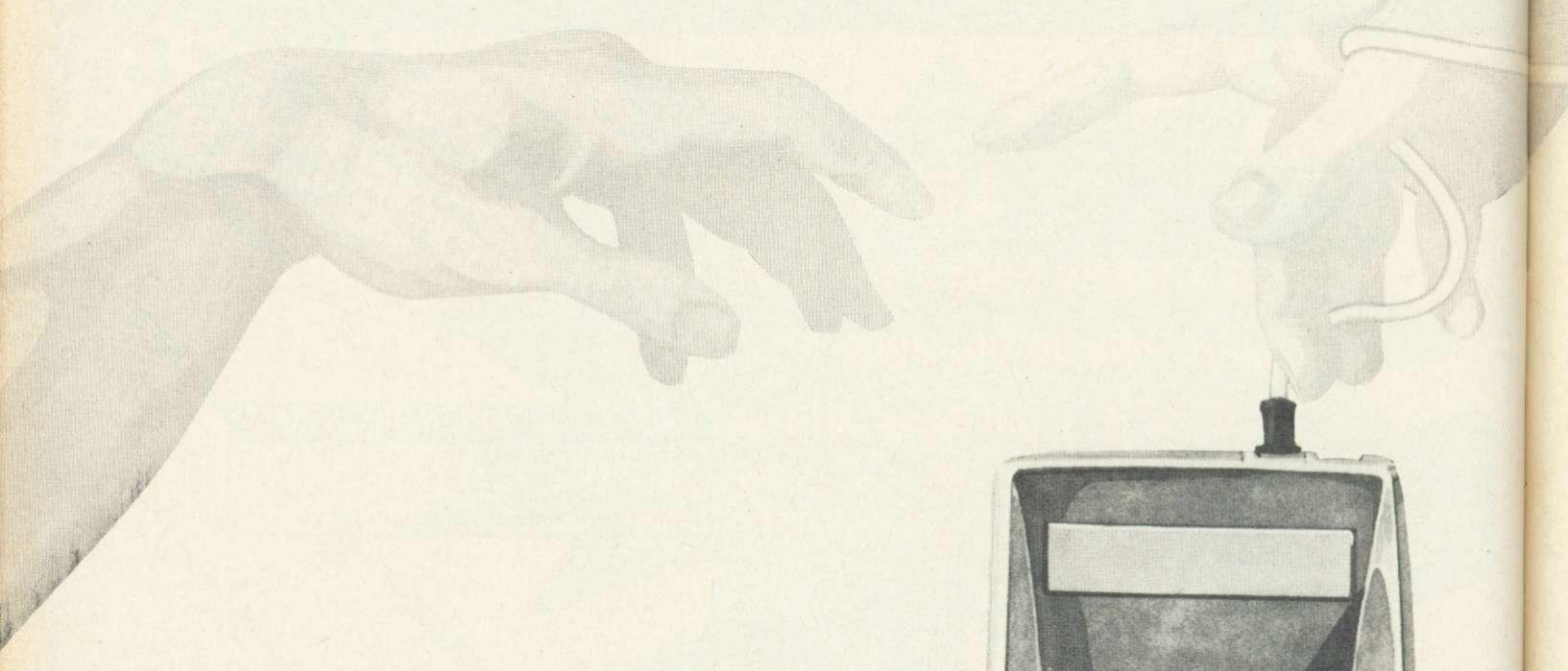

IMAGINE A KEYBOARD

... so simple to use that in under an hour you're touch typing the entire alphabet, numbers and punctuation.

... so effortless it needs only one hand, your eyes never leaving the screen or the document you're copying.

A keyboard you can hold in your palm, and yet, so powerful, it can replace every input, command and function key of your BBC computer...

Just think how effortless it would be if you could *touch type* your programs, data and text.

How you could lean back and relax; be faster and more accurate; your mind free to think, and your eyes to read.

IT'S CALLED **QUINKEY**

And for **£49.95** you'll get everything you need — hardware and software — to use Quinkey with your BBC computer.

HOW CAN 6 KEYS DO THE WORK OF 72?

You simply press the keys in different combinations. Each combination represents a character.

Quinkey has 5 keys plus a Control key, each finger belonging to its own key — so there's no need to hunt and peck... BUT...

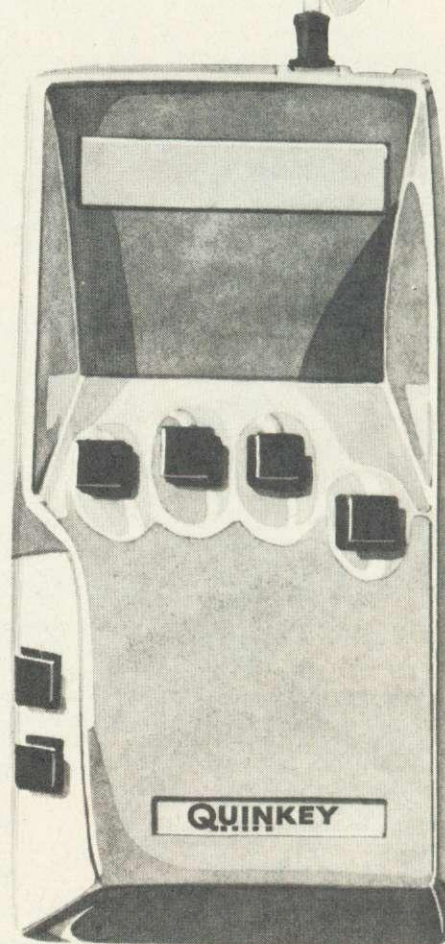

... HERE'S THE MAGIC!

Look at these diagrams:

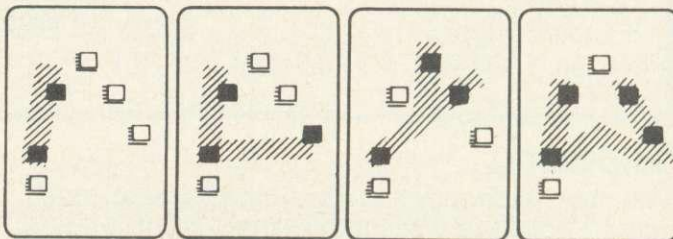

See how the lines joining the key combinations form the characters? For each letter there's an instantly recognised and easily memorised visual clue.

That's the trick — and it works!

YOU CAN TRY IT NOW!

Rest the fingers of your right hand on a table top. Imagine the keys.

To write an "I" you press your Thumb and Index finger down at the same time.

For an "L" you press your Thumb, Index and Little fingers.

To write "Y" you use your Thumb, Middle and Ring fingers . . . and so on.

That's all there is to it.

Here's what users are saying about the keyboard:

- PETER RODWELL (as Editor of 'Personal Computer World') "took me half an hour to learn the alphabet . . . far easier than learning to type. It's an addictive device, and I'm starting to wonder how I ever managed without one."

- PETER WHEELER (in the 'Times Educational Supplement') "a new user can start to touch type after one hour's usage."

- FRANK DALE (BBC Producer - writing in 'Electronic Times') "no other machine is so easy to use, so easy to learn, so generally useful . . ."

NO RISK, MONEY BACK GUARANTEE.

If you're unhappy with your Quinkey just return it within two weeks for a full and courteous refund.

ONLY £49.95 (including VAT and postage & packing).
HERE'S WHAT YOU GET.

- ★ One Quinkey keyboard.
- ★ Breakthrough multi-channel interface for up to four keyboards (plug into analogue port).
- ★ Two new powerful software packages, PROG & WP (described below).
- ★ Comprehensive Quinkey manual.

"PROG" and "WP" (free with the Quinkey package) are utility programs written specially for the BBC.

"PROC" enables your BBC to recognise and interpret the signals from the Quinkey keyboard. It combines easily with your application programs enabling you to use Quinkey as a comprehensive alternative keyboard.

"WP" optimises Quinkey to work with word-processing packages "Wordwise," "View" and "Edword" - a perfect text-writing combination.

KEYBOARD RANGE.

All BBC "B" keyboard inputs generate from the Quinkey, except the hard-wire key, "Break."

TECHNICAL DATA:

Loading length: &605. Running length: &300.
No zero-page locations, all ADC channels.
Interrupt service vector IRQ2V, correctly chained.

TESTED COMPATIBILITY

BBC Model "B"

Acorn

OS 1.2

BASIC I or BASIC II (unless using INKEY with negative argument)

Acorn

DFS 0.90

Acorn

View A1.4

Acornsoft

Wordwise 1.17

Computer Concepts

Edword

Clwyd Technics

QUINKEY IN THE CLASSROOM.

Quinkey keyboards allow up to four children to use one BBC computer at the same time. "QUAD" software supplied with the Educational Pack enables children to write simultaneously on a split screen and print out their work separately.

(Send the coupon if you would like more information about the remarkable results that children of all ages and abilities are having with Quinkey.)



Order from your nearest BBC Acorn dealer or by sending in the coupon below, now.

microwriter

An associate company of the Hambro Life Group of Companies

31 Southampton Row, London WC1B 5HJ

To: Vector Marketing Ltd., Denington Estate, Wellingborough, Northants. NN8 2RL.

PLEASE SEND:		
001	Quinkey pack(s) @ £49.95	£ _____
002	Extra keyboard(s) @ £29.95	£ _____
003	Educational Pack(s) @ £148.80 (Quinkey pack plus 3 extra keyboards and additional "QUAD" software)	£ _____
	postage and packing	£ 2.50

I realise that I can return the pack(s) undamaged within two weeks of receipt of order, if I am not fully satisfied, for a complete refund.

Send more information about Quinkey in the classroom.

I enclose a cheque made payable to:
Vector Marketing "Microwriter Ltd" for £ _____

Or debit my Visa/Access credit card No. _____

SIGNED: _____

NAME: _____

ADDRESS: _____

MU 7/84

Please allow up to 28 days for delivery.

Reg. no. 1374069

microwriter
QUINKEY

THE BEST IDEA SINCE THE HUMAN HAND

BBC NEWS FROM DPI

- Case to hold one drive
- Ribbon cable to connect one drive to BBC Micro
- Power cable to power one drive from BBC Micro
- Switch on rear of case to select 40 or 80 TPI operation when using FD55E or FD55F.



BBC COMPATIBLE FLOPPY DISC SYSTEMS AND DRIVES

- CASE to hold two drives (complete with blanking panel for use should only one drive be installed).
- Ribbon cable to connect **two** drives to B.B.C. Micro.
- Integral power supply for **two** drives.
- Switch on rear of case to select 40 or 80 TPI operation when using FD55E or FD55F.

THIS CASE CONTAINS ALL HARDWARE NECESSARY FOR TWO DRIVES. JUST SELECT ONE OR TWO DRIVES FROM THOSE SHOWN BELOW. IF YOU SELECT JUST ONE NOW, THE SECOND CAN JUST PLUG IN LATER. CASES ONLY SOLD WITH DRIVES.

TEAC. FD55 SERIES 5.25" 1/2 HEIGHT SLIM-LINE DISC DRIVES.

	Capacity	40TPI	80TPI	Price
FD55A	40 Track. Single Sided.	100K	N/A	£130
FD55B	40 Track. Double Sided.	200K	N/A	£180
FD55E	40 or 80 Track. Single Sided.	100K	200K	£155
FD55F	40 to 80 Track. Double Sided.	200K	400K	£218

HANDBOOK AND FORMATTING DISC

£15

DELIVERY: Up to 28 days.
WARRANTY: 90 days.
TERMS: Strictly cheque with order.
Send to P.O. Box 11, Stroud, Glos. UK GL5 1JN.
or phone through your
Access or Barclay Card number.

TO ORDER: ADD CARRIAGE/PACKING/INSURANCE AT £10 (COVERS NEXT DAY SECURICOR DELIVERY). THEN V.A.T. AT 15% TO TOTAL. THE ABOVE PRICES ARE VALID UNTIL END OF APRIL 1984.



PRINTER AND PLOTTER — MCP 40

- 4 colours
- Selectable 40 or 80 characters per line
- Easy to use—simple software commands
- Standard Centronics interface—cables available for most micros
- Uses 4 1/2" plain paper
- High resolution—over 100 steps/inch



DIGITAL PERIPHERALS LTD.

Rodney House, Church Street, Stroud, Glos. U.K. GL5 1JN
Tel: (04536) 71387. Telex 43551.

A **Cristie** Company

diamondsoft
A better way of computing

NOW
on 40/80 track
DISC

BBC
i

Integrated Accounting

Business Software for the BBC microcomputer

The **complete** disc based package:

- Sales / Purchase / Nominal Ledgers
- Cashbook ● VAT Accounting
- Full double entry system
- Trial Balance ● Age Analyses

£125

Requires 40 or 80 track disc drive(s) and printer.

Please add VAT and send remittance (or send for more details) to:

Diamondsoft Ltd., FREEPOST,
Cheadle Hulme, Cheshire, SK8 5YB Tel: 061-485 8705

diamondsoft
A better way of computing

THE DATABASE SOFTWARE FOR THE BBC THAT GROWS WITH YOUR NEEDS

Filebase II

£19.95
inc.

- Operates on any format DISC or CASSETTE
- Unique TURBOFILE and MAXIFILE options
- HIGH CAPACITY files (up to a full disc with the MAXIFILE option)
- Files created to USER DEFINED format
 - up to 20 items per record
 - each record up to 255 characters
- VIEW file by easy use of cursor keys
- PRINT files (optional report layouts)
- Print LABELS
- Powerful SEARCH features
- SELECT records to view, print, count, total, change or write a file
- SORT file on any item
- Convert TURBOFILE to MAXIFILE (on disc)

Requires BBC 32K (OS 1.0 or later). Optional disc/printer. Supplied on cassette — loads to any format disc.

Can be supplied on 40 track disc (please add £3)
Overseas orders please add £2.50 to cover postage.

Cheques or P.O. to Diamondsoft Ltd., FREEPOST,
Cheadle Hulme, Cheshire SK8 5YB. Tel: 061-485 8705 (24 hrs).

SOFTWARE CHART

TITLE	PUBLISHER	PRICE	MICRO	REVIEWED
1 (—) Aviator	Acornsoft	£14.95 (£17.95)	B	May '84
2 (1) Fortress	Amcom	£8.95	B	September '84
3 (—) Blagger	Alligata	£7.95	B/E	
4 (12) Battletank	Superior	£7.95	B	September '84
5 (5) Twin-Kingdom Valley	Bug-Byte	£9.50	B	
6 (4) White Knight II	BBCSoft	£10.00	B	January '84
7 (14) Mr Wimpey	Ocean	£6.90	B	
8 (3) 737 Flight Simulator	Salamander	£9.95	B/E	December '83
9 (—) Football Manager	Addictive	£7.95	B	
10 (—) Overdrive	Superior	£7.95	B	September '84
11 (2) Snooker	Visions	£7.95	B/E	
12 (6) Dare Devil Denis	Visions	£7.95	B/E	July '84
13 (7) Chukkie Egg	A&F	£7.95	B/E	September '84
14 (—) Lords of Time	Level 9	£9.90	B	July '84
15 (13) Hunchback	Superior	£7.95 (£11.95)	B	September '84
16 (re) Killer Gorilla	Micro Power	£7.95	B/E	November '83
17 (10) The Hobbit	Melbourne House	£14.95	B	
18 (9) Cylon Attack	A&F	£7.95	B/E	April '84
19 (—) JCB Digger	Acornsoft	£9.95 (£11.50)	B	June '84
20 (—) Ghouls	Micro Power	£7.95	B	June '84

B=BBC E=Electron re=re-entry Prices in brackets are for disc version

BUBBLING UNDER

Mr Men (Mirrorsoft)
Jet-Power Jack (Micro Power) – reviewed July '84
Guardian (Alligata)

Sheepdog (Longman)
Confrontation (Lothlorien)

Compiled by RAM/Computer

ZOOM – straight up to number 1 goes *Aviator*, without even observing the formality last month of bubbling under – and we're sure it'll stay sky high for quite a while. Just as spectacular – because his arrival was more sudden – is the way Roger the Dodger, master burglar, has stolen his way into our chart in *Blagger*.

Otherwise things look quite stable, with *Fortress* only just slipping from number 1, the *Twin-Kingdom Valley* adventure level-pegging with last month and *White Knight* defending itself well at number 6. Flight

simulator *737* is also enjoying a long run.

Five more new entries, too, but at only number 19 *JCB Digger* is making a shaky start to its progress up the list – it is, after all, nicknamed 'JCB Judder'. And *Ghouls* at number 20 isn't proving as spine-tingling as its name suggests. *Lords of Time* has warped in at number 14 and Sue Gazzard's witty, fast and ingenious concoction deserves to climb high.

Even out of season, *Football Manager* has shot into the premier league, closely pursued by *Overdrive*. Superior's car chase

game, though, is surely too straightforward to stay the distance (review page 157). If you don't already know, find out in this issue why *Cylon Attack* and *Chukkie Egg* have been such tenacious middle-rankers.

Bubbling Under features some almost-unknowns, but perhaps most interesting is one that isn't there at all: Aadvark's *Frak!* The game, named after the bubble captions its hero produces, uses some lovely sprite graphics centring on a caveman and his handy yo-yo. Look out for it! (review page 155).

M I C R O P O W E R M I C R O P O W E R M I C R O P O W E R



GET ON THE RIGHT TRACK WITH MICRO POWER



Micro Power are an official service and information centre, and we are major suppliers to Government and educational establishments. We stock the complete range of Acornsoft and Micro Power software as well as a wide range of B.B.C. Micro and general computing books. Our expert staff are always on hand to provide advice and assistance in the relaxed atmosphere of our showroom.

COMPUTERS

SUMMER SPECIALS

- B.B.C. Micro + Cassette Recorder AND Five Micro Power or selected Acornsoft Tapes 399.00
- B.B.C. Model B plus DFS + 4 tapes 469.00
- B.B.C. Model B plus Econet + 4 tapes 446.00
- B.B.C. Model B plus DFS and Econet 516.00
- Acorn Electron + Cassette Recorder OR Five Micro Power Tapes 199.00

MONITORS

- Kaga 12" Green Screen 123.05
- Ferguson TX Monitor/TV 335.95
- Sanyo DM2112 12" Green Screen 74.95
- Microvitec 14" RGB/PAL and audio output 258.75
- Microvitec monitor (plastic) 286.85
- Microvitec monitor (metal) 228.85
- Plinth for above 5.75

DISK DRIVES

- Pace 40 track 100K 156.40
- Pace 40 track double sided 200K 220.80
- Pace 40/80 track double sided 200/400K 241.50
- Pace 40 track dual drive 200K 310.50
- Pace 40 track double sided dual drive 400K 434.70
- Mitsubishi 40/80 track double sided dual drive 400/800K 567.85
- Torch Z80 Disk Pack 80 track double sided dual drive (including Perfect software) 803.85
- AMS HFD 3055 3" 100K 199.00

ALL PRICES INCLUSIVE OF V.A.T.
We provide free fitting for all firmware.

PRINTERS

- Epson FX80 416.40
- Epson RX80 F/T 268.90
- Juki 6100 Daisywheel 375.00
- Smith Corona TP-1 daisywheel 270.20
- Cannon PW1080 332.58

ACCESSORIES

- Acorn B.B.C. cassette recorder (inc. leads) 35.00
- Morwood B.B.C. cassette recorder (inc. leads) 29.95
- Sureshot self-centering arcade joystick 18.22
- Micro Power potentiometer joystick 12.95
- Acorn Disk Interface (Free 1.2 ROM if req.) 97.00
- 1.2 ROM upgrade 11.50
- Speech synthesiser plus cartridge socket (Free 1.2 ROM if required) 55.00
- View wordprocessor ROM 59.80
- Wordwise wordprocessor ROM 45.42
- Electron Plus 1 printer/joystick interface 59.90
- First Byte Electron joystick interface (including cassette) 24.95
- ATPL sideways RAM board 45.00
- Teletext adapter (Free 1.2 ROM if req.) 225.00
- Softlight EPROM programmer 75.90
- Printer cables (parallel or serial) 15.50
- System Sac (B.B.C. canvas carrying case) 19.95
- 3M unlabelled disks (ten) 15.00
- Scotch D/S D/D disks (Box of ten) 32.50
- Maxell 3" disk 4.95
- Disk storage case 19.95
- Vinyl dust cover for computers, disk drives, monitors and printers 4.50
- Stack light pen 28.75
- Tutor Mate Monitor stands 10.50

Wide selection of computer leads and printer ribbons in stock.

ALL ROADS LEAD TO MICRO POWER!



*HP facilities available. Please contact us for further details.

*Free parking. All prices correct at time of going to press.



Showroom: MICRO POWER LTD., Northwood House, North Street, Leeds LS7 2AA; Tel: (0532) 458800

Mail Order: MICRO POWER LTD., Dept. AU9 Sheepscair House, Sheepscair Street South, Leeds LS7 1AD; Tel: (0532) 434006

Send an SAE for our complete listing of hardware, software and books.

CARRIAGE FREE for ALL hardware

Books and software only 55p per order U.K. Mainland Only

SPECIALISTS IN ECONET



M I C R O P O W E R M I C R O P O W E R M I C R O P O W E R

UNICORN: CHEAPEST ROUTE TO UNIX

Andrew Cummins and Peter Voke test Torch's 16-bitter

THE Unicorn system from Torch is a good deal more expensive than other second processor systems, but it gives you something special for your money. The system given for review contained a 68000 (16-bit) second processor with a quarter megabyte of RAM (256k), a Z80 processor with 64k of RAM, a 20Mb hard disc drive, and a single 5¼in floppy drive with a slimline profile, similar to one you may already have connected to your BBC micro, storing up to 400k. The whole package sat in a buff-coloured box that stood on one of its ends beside the BBC micro, looking rather like a squat tower 7½in wide, 10½in deep and 12½in high.

It had to be connected to the BBC micro not only via the Tube, but also through the 1MHz bus (for the hard disc) and the disc drive port (for the floppy). This took about 20 minutes to sort out, and left the squat tower of the Unicorn a few inches from the right hand side of the BBC—close, but not so close as to interfere with typing. The fan in the Unicorn was pleasantly quiet; it was a while before we noticed it at all.

Normally, on receiving a Unicorn system the user would have to load the main utilities (CPN, Perfect software, and Unix—more on these later) from the dozen or so floppy discs. This exercise might well take a day if you encountered problems, but fortunately we were spared the exercise: Torch had already loaded up the hard disc with everything. Once that is done, it should not need to be repeated, short of disaster. The only other thing to be done is to put a ROM in the BBC micro in one of the spare slots. Then you are ready to go.

First impressions of using the Unicorn revealed some good, some bad features. We were using a colour monitor and found the mode 1 80-column display the best to use. This would not have been acceptable on a TV, so a monitor is really necessary, preferably a good resolution monochrome monitor—you are unlikely to need colour. It is in fact quite easy to issue instructions to the BBC (which is acting here as a front-end processor, chief cook and bottle-washer to the 68000) from within the CPN environment, to change the screen background colour, mode or anything else.

Less satisfactory was the way that the Unicorn ignored several obvious

terms, is constantly swapping data in and out of disc, and pressing BREAK as often as not left the hard disc corrupted.

Paging mode (CTRL-N) was switched off, and could not be changed. Small points like this, making use of the best features of the BBC micro, could make the difference between the Unicorn being a joy to use and being frankly annoying.

Once the Unicorn is connected and working, the user is interacting with the CPN operating system running on the Z80. To anyone familiar with CP/M 2.2 this will not bring many surprises. All the utilities you would expect are there. We found this part of the system easy to use and the documentation first-class.

Supplied to run under CPN is a package of integrated business applications programs under the Perfect label. There are three programs, the *Perfect-Writer* word-processor, *Perfect-Calc* spreadsheet, and *Perfect-Filer* database program. These have a standard command structure and inter-workable files, as you would expect of a properly integrated package.

Perfect-Writer and *Perfect-Calc* are both quite ade-

quate, the wordprocessor being analogous to *Wordstar* but including a spelling checker and mail-merge facilities. *Perfect-Filer* is a fairly simple database program.

Documentation was again excellent with tutorials available on-screen if required.

The command inputs and printer drivers were configurable, but there was no real evidence that the packages had been tailored to use any features of the BBC microcomputer: it was



A Unix combination: monitor, Beeb and Unicorn box containing 68000 second processor, Z80 processor, 20Mb hard disc drive and 5¼in floppy drive

special features of the BBC micro. For instance, the ESCAPE key was not used, as it clearly should be, to generate the normal escape code of Unix (^C).

More serious was the fact that the BREAK key was left in normal operation. It is difficult to make sure that pressing the BREAK key leaves all processors and disc drives in a reasonable condition: difficult, but not impossible. In our opinion it should have been done. The Unicorn, like all Unix sys-

STACOM - STACOM - STACOM

Disk Drives for the Acorn user



Stacom Distribution Ltd, are main distributors for Datafax Disk Drives in the U.K.

Whatever your needs . . . talk to us.

An amazing range of top quality drives, supplied with leads, cables and utility disks from a single 100K (200K flipable disk) with or without power supply unit, right through to a dual 400K, double sided unit (800K double density) with power supply unit.

We also distribute a complete range of 5 1/4" disk drives.

All finished in an attractive metal case to match your BBC

datafax

STACOM DISTRIBUTION LTD, 15-17 CHEAM ROAD, SUTTON, SURREY SM1 1SW 01-661 2266

CUBE INDUSTRIAL MICROCOMPUTER SYSTEMS



The CUBE range of industrial microcomputer modules, with BBC BASIC or FLEX, can provide the complete solution to your microprocessor control application.

Develop your target application with:

- BBC BASIC, using our EuroBEEB 6502 target processor developed with a BBC Microcomputer.
- PL/9, Pascal or 'C', using our Eurorack system or our BeebFLEX 6809 Second Processor for the BBC Microcomputer.

Extend your system with our comprehensive range of peripheral Eurocards which includes memory, high-resolution video, digital, analog and serial I/O, floppy disk controllers, EPROM programmers, and many more.

Control Universal Limited

CUBE Industrial Microcomputers

Andersons Court, Newnham Road,
Cambridge CB3 9EZ. Tel (0223) 358757

If you want to know more about CUBE products, please contact our team of sales engineers for an appointment at our premises or yours.

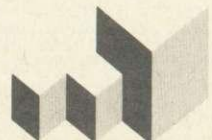

really just acting as a CPN terminal.

The main feature of the Unicorn is its low-cost approach to providing Unix. If you have a BBC micro and want CP/M plus applications software, you will probably get a second processor from Acorn or elsewhere. The person who buys the Unicorn is paying a lot more and is presumably looking for more, namely the Unix programming environment.

For those unfamiliar with Unix, it will be useful to give some idea of what it is (or should be) and what it does. Unix is not just another operating system (like CP/M) or even a super-operating system. Originally designed in 1969 as a multi-user scheduling program or time-sharing system, it has come to include so many powerful tools and utilities that it is probably the programming environment *par excellence*: not so much a system, more a way of life. The only comparable environment I've come across is the Structured Programming Facility now available on IBM and Amdahl mainframes.

Unix, however, has been around a lot longer than SPF, and, because its 'kernel' is written in the high-level language C, it has spread rapidly to every level and type of computer. Anyone who can provide a C compiler and some machine-specific routines to handle disc drives, I/O and so on can put Unix on their machine. Now it is becoming available on microcomputers. In ten years' time, the megabyte micros we all hope to have will almost certainly provide Unix or a descendant of it.

What does it do? A good Unix system should provide compilers/interpreters for all the well-known languages: Pascal, Basic, Fortran, Cobol, C (of course) and perhaps more specialised languages such as Lisp. It gives the user a convenient hierarchical file structure that keeps his files separate from those of other users, protecting access by means of passwords. It provides a large number of utility programs—usually several hundred in all—that can be called up by a simple command from the keyboard. And the commands in turn can be combined or altered by the user at will, to create new commands to his own specification.

The people who created and developed Unix were programmers. They wanted the kind of power that normal operating systems, then and now, have a habit of denying programmers—who, after all, are the ones who actually use operating systems. If you've ever looked up something in a manual, found you can't do it, and said to yourself 'Why not?', then Unix was made for you.

The result is that Unix is very flexible,

very powerful, rather complex, and potentially dangerous. For instance, the commands tend to be terse, that is, short two or three-letter abbreviations. This makes Unix somewhat more difficult to learn than your average micro-computer Basic, but less frustrating to use once one is adept. The whole Unix system is now sufficiently complex for even an experienced user to overlook the best way of doing something, or simply do it wrong. Unix is not really a system for the beginner in computing or the business person with a smattering of computer literacy. It is a programmer's tool, not an executive toy. Unix is like a blunderbuss in that it is easy to shoot yourself in the foot unless you are careful. If you know what you are doing, it will help you to lick programming problems faster than you ever knew you could.

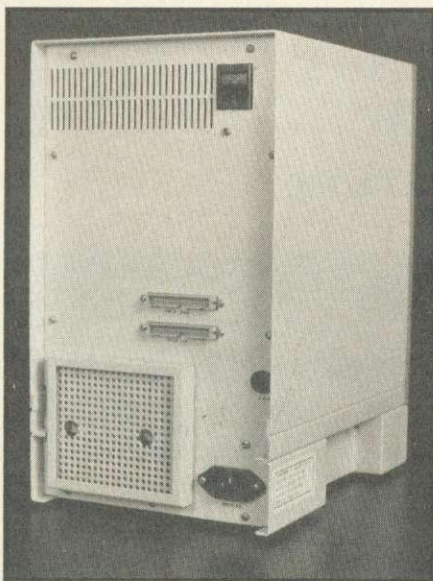

Back of the Unicorn box showing connections to 1MHz bus and disc interface, with power switch (top) and cable connection (bottom right)

Just to give a taste, here are some of the utilities available on the Torch Unicorn Unix, and any other decent Unix system. You have the choice of several editors including 'ed', which is fairly simple, and 'vi', which is, if anything, too powerful. You have 'sed', a search-and-replace editor.

The number of file manipulation programs is enormous. You even have programs that allow you to create your own computer language and compile programs in it, as well as being able to run programs in any of the existing common languages. You can create your own commands, either by combining existing commands or from scratch, using C. There is 'nroff', a text formatter, and 'sccs', designed for software project control.

You have full control over your filing

system, I/O, and the destination of the output from any process. Fundamental to Unix, in fact, is the idea of stringing programs together so that the output of one becomes the input of the next; the implications of this in text-processing applications are mind-boggling.

You can set up one program to run in the background while you get on with something else. If you don't like the command structure ('shell', in Unix jargon) you are working in, pick another—or create your own. Unix is all about freedom and power, breaking down barriers to what you want to do rather than creating them, as other more limited operating systems frequently seem to do.

It all sounds wonderful, and indeed it is. People who get to know Unix well usually have nothing but praise for its power and flexibility, and if you are already a Unix user you will probably not need convincing.

The Unicorn, however, is a rather special implementation of Unix. If you already own a BBC micro with disc interface and high-resolution monitor, it will be the cheapest way of getting hold of Unix. Even if you don't own a Beeb it is still a cheap route to Unix. The problem is that, to some extent, you only get what you pay for. The power of Unix carries a cost, in terms of memory requirements and speed, that the Unicorn is barely capable of meeting.

Unix is entered from CPN by typing 'unix'. There follows a long logging-in sequence, in which the first big disadvantage of running Unix on the Unicorn becomes quickly apparent. Everything takes much longer than one is used to on bigger machines (or with less ambitious systems on smaller ones), even though only one person at a time can use the Unicorn.

The reason for the slowness is partly that the system I was given had 'only' 256k of RAM for the 68000 to use, and upgrades to 512k or 1Mb (available towards the end of this year, according to Torch) would allow easier caching of the hard disc transfers. However, another feature of the design is also fundamentally responsible for the slowness; the hard disc (and the floppy too) are not controlled directly by either the Z80 or 68000 processors within the Unicorn box. Instead they are connected separately to the BBC micro through the 1MHz bus and the disc port respectively.

In the case of the hard disc, this presents a severe bottleneck for transfers from the disc to the Unicorn processors. All data has to go via the 1MHz expansion port, through the 6502 in the BBC micro and back out along the Tube to the 68000. This convoluted journey is

page 165 ►



NEW FOOD FOR YOUR BEEB!

NEW LOW SUMMER PRICES!

Looking for something different? Third Program software will prove to your sceptical friends and family that the computer is not so bad after all!

HOROSCOPES

Produces personalised horoscopes, based on the traditional personality attributes of the twelve signs of the zodiac. Terrific at parties, and a lucrative fund-raiser at fetes etc.

WHAT MAKES YOU TICK?

A personality profile test, based on your responses to fifty questions which rate you on two personality dimensions - introversion/extroversion and stability/neuroticism.

BEST SELLERS

A unique concept from Third Program! Choose between a slushy romance, a spy story or a whodunnit, and the computer writes a "novel" with YOU as the hero or heroine! You can even specify the name of your paramour!

Horoscopes and What Makes You Tick? are available for the BBC Micro 32K or the Acorn Electron. State which when ordering. Best Sellers is for BBC only.

One program £4.95
Two programs £8.90
All three £11.85.

One 40-track disc for only £2 extra per order.

Orders to:

Third Program, 50 Peel Road, Chelmsford, Essex CM2 6AL.

THIRD PROGRAM

... THERE IS A SOFT OPTION!

SCREEN HANDLER ROM BBC MICRO MODEL B (OS 1.0 and later)

- ★ No more tiresome bottom line entry
- ★ Create/amend screen formats on screen
- ★ Full screen data entry in fields
- ★ Full edit facilities
- ★ Error highlighting
- ★ Greatly increases program efficiency
- ★ Uses no RAM - dramatically reduces program size
- ★ User program calls ROM based machine code routine to display screen and handle data entry
- ★ Easy to fit and use - full instructions supplied

£29.95 inc. only from

MICROSOLVE (BOLTON) LTD.
60 Birches Road, Turton,
Bolton BL7 0DX. Tel. 0204 852922

Cash with order or send SAE for full description

Micro Resources Limited

Southfield House, 11 Liverpool Gardens, Worthing, Sussex BN11 1RY
Telephone: Worthing (0903) 213174

BBC Model B	£399.00
BBC Model B Disc Interface	£469.00
BBC Model B Econet	£446.00
BBC Model B Econet & Disc	£516.00
Acorn Electron	£199.00

Acorn 6502 2nd Processor £199.00

This allows the BBC Model B to run faster with greatly increased memory especially in high resolution graphics modes, the package includes Tube software, the latest version of the DFS & NFS called DNFS, a Rom containing Hi-Basic and a comprehensive User Guide.

Acorn Z80 2nd Processor £299.00

If you have wondered how to make the best use of your BBC for Business, then the Z80 2nd Processor and CP/M must be the answer. This package comes with a suite of business programs, including Memoplan, Fileplan, Graphplan, Accountant, BBC Basic (Z80 Version), Cobal, Neculeus (Programming Aid), Professional Basic. This software alone is worth hundreds of pounds and with CP/M you can buy any of the programs written for this operating system.

Dual 800K Disc Drive £359.00

Superb British made disc drive unit ideal for use with the 280 2nd processor.

Acorn Teletext Adaptor £225.00

Allows the downloading, storing and running of programs via Ceefax, transmitted free of charge, pages can also be saved and printed from all 4 channels.

Acorn Bitsik £375.00

This superb menu driven graphics package allows high quality CAD at a modest price. Needs 6502 2nd Processor and dual 80 track discs drives, a must for all design teams.

Acorn IEEE 488 Interface £325.00

Provides computer control of compatible scientific and technical equipment. Useful in experimental work in industry and education.

Acorn Word Processor View £59.00

This Rom based word processor has many advanced features including macros, still one of the best available on the market.

Acorn Spreadsheet Viewsheet £59.00

A new spreadsheet from Acornsoft comes in a 16K Rom with a comprehensive manual, it is compatible with view and the 6502 2nd processor.

Mass Marco Assembler £35.00

A superb machine code assembler in Rom, includes comprehensive manual where the user is introduced to Mass and given step-by-step guide to writing source code and assembling it using Mass. Also includes a utility disc with many useful routines.

All prices include VAT and delivery

QUINKEY FINGERS

Peter Voke lays a hand on the new Microwriter add-on for the Beeb

A SURPRISING new hardware add-on for the BBC micro has appeared. The Quinkey is a one-handed keyboard produced by Microwriter that provides a novel way of accessing the computer. It costs a little under £50, including VAT.

The Microwriter, from which the Quinkey is derived, was invented by a film director, and is reputed to have been used to write the film *Zulu Dawn*. That may not strike everyone as much of a recommendation, but the Microwriter has survived, and flourishes. Basically a portable text-recording device, in the Quinkey it has found a new and potentially revolutionary application as a plug-in keyboard for the Beeb. Versions are likely to follow for the Electron, the Spectrum, and the Commodore 64.

What is special about the Quinkey? First, in place of the conventional typewriter keyboard there's a specially shaped block about the size of a paperback book, with just six keys on it. Five of these six keys lie naturally under the fingers and thumb of the right hand, while the sixth is reached by a slight downward movement of the thumb. On starting to use the Quinkey the naturalness of the position of one's hand compared to a conventional keyboard is immediately apparent – and one can sit back in an easy chair with the Quinkey on one knee, rather than having to hunch over the keyboard in the usual hacker's style. Microwriter has been sensible enough to give the Quinkey a long lead.

So, one up for the Quinkey: no more backache. The next test is whether it does what it is supposed to do. The letters of the alphabet are entered by pressing combinations of fingers on the right hand, as a pianist plays chords, rather than one key at a time. This might sound more complicated than typing, but you quickly discover that the claims of Microwriter are no exaggeration: the finger combinations have been chosen to seem so natural that it takes only a few minutes – literally – to remember all the shapes for a to z. I didn't believe this claim until I tried it

myself, but only needed to go back to the manual once to check a few letters a second time.

To cope with the BBC control codes (things like CTRL-U and CTRL-N) the Microwriter scheme has been extended in a simple way, and one presses a special 'shape' with one's fingers (COM-X) followed by the letter concerned. Yet another special shape (COM-H) allows the Quinkey to mimic the red function keys on the BBC micro, and a few non-standard characters



Microwriter's Quinkey, a 'complete alternative keyboard' for the BBC micro at £49.95

such as # and >. It might seem impossible to remember all the finger combinations involved, but once the basic 26 letters and five common punctuation marks are learned, the rest comes fairly naturally.

Microwriter claims that people take to the Quinkey-style keyboard much quicker than to a qwerty typewriter layout. A typing speed of 25 words per minute is reached faster, though it is difficult to get beyond 40 or 45 words per minute because of the one-handed nature of the action. This is likely to bother only the superfast professional typist, who can get up to 90 words per minute on a qwerty keyboard, and is not really a limitation for the micro user. Having used a Quinkey for a couple of hours, I am convinced Microwriter is correct.

The Quinkey arrives from Vector

Marketing in a good solid polystyrene pack, with a separate interface pack. The latter contains a user's guide that is exceptionally clear and complete, with a useful technical section at the back. (One or two small points: the use of the thumb key alone for the space character is not dealt with properly along with the other main letters, and numeric-X actually produces an asterisk, not a letter X.)

In addition you get a small adapter, which plugs into the back of the micro-computer, allowing four Quinkeys to access the computer simultaneously. I had only one Quinkey and so cannot comment on the practicality of up to four people using the computer simultaneously.

To use the Quinkey you obviously have to program the Beeb to accept its input, and Microwriter provides two programs on tape to do this. One, called *Prog*, is for ordinary use in programming, or in programs designed to use the Quinkey input, and the other called *WP*, is for use with wordprocessors. The Quinkey works with either *Wordwise* or *View*.

In addition, the tape has a tutor program which some people may like to use, although it isn't really needed to learn to use the Quinkey.

When the *Prog* is run, it relocates some machine code of length &300 bytes to just above PAGE, and shifts PAGE up by &300. You now have a situation rather like that produced by an extra ROM that uses private workspace. The three pages you have lost are occupied in this case by the software that reads the Quinkey keyboard.

What happens is that the 100Hz interrupt from the system VIA is intercepted through IRQ2V and redirected to the Quinkey software. This technical mumbo-jumbo boils down to some-

PRICES

Basic: Interface, keyboard and two software packs, £49.95 (each keyboard £29.95)

Education: Interface, four keyboards and multi-user software, £148.80

What the competition hasn't been waiting for.

Latest version of Forth for the BBC
(Is not rehashed Forth 79 Code)

Unique Stack Display Utility



16k Eprom type 27128

Multi-tasking operating system
for Real-Time use.

Here's the Forth Eprom for the BBC Micro that makes all others out of date.

It's Multi-Forth 83 from David Husband who has built his reputation for Quality Forth products with his ZX81-Forth ROM, Spectrum Forth-I/O Cartridge and now New Multi-Forth 83 for the BBC Micro. This is not rehashed Forth 79 Code, but a completely new version of the Forth 83 Standard. It's unique in that it Multi-tasks, and therefore the user can have a number of Forth programs executing simultaneously and transparently of each other.

Multi-Forth 83 sits in the sideways ROM area of the BBC along with any other ROMs in use. It is compatible with the MOS, and specially vectored to enable a system to be reconfigured. It contains a Standard 6502 Assembler, a Standard Screen Editor, and a Unique Stack Display Utility.

With this Forth, David Husband has provided the BBC Micro with capabilities never before realised. And being 16K rather than 8K is twice the size of other versions. Multi-Forth 83 is supplied with an

extensive Manual (170 pages plus) and at £45+VAT it is superb value.

Order it using the coupon adding £2.30 p&p (£5 for Europe, £10 outside) or if you want more information, tick that box instead. Either way, it will put you one step ahead of the competition.

Please send me Multi-Forth 83 for BBC Micro. £45+VAT. De-luxe System inc. Disc £80+VAT
Cheques to Skywave Software Readers' A/C (or enter Visa No.)

Name _____
Address _____
Post code _____

Please send me more information:
 Multi-Forth 83
 ZX81-Forth ROM
 Spectrum Forth-I/O Cartridge

Skywave SOFTWARE

SUBJECT TO AVAILABILITY. FOR 1.0.5 ONWARDS.
Send to Skywave Software, 73 Curzon Road, Bournemouth,
BH1 4PW, Dorset, England. Tel: (0202) 302385

MULTI-FORTH 83 FOR THE BBC MICRO

3D COMPUTERS

THE HOME COMPUTER
SPECIALISTS

WITH MORE BRANCHES THAN
ANY OTHER ACORN DEALER
WE OFFER

ONE-STOP SHOPPING

FOR YOUR
BBC MICRO
AND
ELECTRON

SPECIAL ELECTRON PACKAGE INCLUDES
JOYSTICK INTERFACE + QUICKSHOT
JOYSTICK WORTH £30

ALL FOR **£199**

INSTANT CREDIT UP TO £1000.

SOFTWARE

PROGRAM POWER
BUG-BYTE
SUPERIOR SOFTWARE
A & F
SIMON HESSEL
MOLIMERX
ALLIGATA
ACORNSOFT

PERIPHERALS

DISCS SINGLE/DUAL
TORCH Z80 DISCS
MIDWICH DISCS
PRINTERS
JOYSTICKS
MONITORS
B & W/COLOUR
LIGHT PENS
BBC BUGGY

*large range of books,
diskettes, cassettes &
printer paper always
in stock*

*Easy parking at all
branches*

TOLWORTH

230 Tolworth Rise South,
Tolworth, Surbiton,
Surrey KT5 9NB.
Tel: 01-337 4317

SUTTON

30 Station Road,
Belmont, Sutton,
Surrey SM2 6BS.
Tel: 01-642 2534

EALING

114 Gunnersbury Avenue,
Ealing, London W5 4HB.
Tel: 01-992 5855

NEWBURY

26, Stanley Road,
Newbury
Berks RG14 7PB.
Tel: (0635) 30047

RICKMANSWORTH

Grey Stone Works,
The Green, Croxley Green,
Rickmansworth,
Herts WO3 3AJ.
Tel: 0923 779250

LUTON

1 Manor Road,
Caddington, Luton,
Beds LU1 4EE.
Tel: (0582) 458575

thing very simple: the BBC micro checks the analogue input a hundred times a second to see if you are doing anything with the Quinkey keyboard. If you are, it updates its 'current key press' and then, when you release the keys completely, puts the character into the input buffer.

One thing to note: the character is input when you release the keys, not before. This is slightly disconcerting at first, but makes sense, since it means that the keys you want pressed don't all have to all go down or spring up together. If they did, using a Quinkey or Microwriter would be impossible.

Taking a look at the machine code that runs the Quinkey, it turns out to be fairly simple but efficient. No workspace is used outside the 3/4k of Quinkey private workspace. You can adjust the action of the Quinkey in a number of ways, simply by knowing a little about what is going on in those three pages. So, for the benefit of present and future Quinkey owners, here are some hints.

First, the characters output by the Quinkey are held in lookup tables, 32 at a time. If *Prog* is loaded at &1900 (set PAGE = &1900 and LOAD 'PROG'), the data tables for all the characters lie between &1C4C and &1D0A. Locations &1C4C to &1C6B contain the ordinary lower-case letters plus the five common punctuation marks produced by the unshifted Quinkey. The Quinkey 'command' codes are in memory from &1C6C to &1C8B (though it is noticeable that the second 16 bytes are all zero, meaning that key presses involving both the thumb keys produce nothing). From &1C8C to &1CAB the capitals are stored, from &1CAC to &1CCB the Quinkey 'numeric shift' characters, and from &1CCC to &1CEB the 'special shift' characters introduced to cope with the BBC function keys and non-standard characters. The BBC control codes (ASCII 01 to 26) follow from &1CEC to &1D0B.

Of course, the characters are not in alphabetical order in these blocks. The position of the characters in the tables determines which character appears on the screen for a particular combination of keys pressed. The five fingers of the right hand each trigger one bit of a five-bit number. For instance, the Quinkey finger shape for the letter 'j' is thumb, ring finger and little finger. The five bit number is therefore 10011, or 19. The Quinkey produces a 'j' in response to this because a 'j' is at position 19 in the table beginning at &1C4C. The little finger alone is the letter 'u', and 'u' is the first letter in the table, as we expect. The whole table from &1C4C contains:

```
usgoqnbev,t,a-.m hjkczxyilrwd'fp
in the form of ASCII codes.
```

This should allow you to reprogram the Quinkey without difficulty. For instance, to swap the Quinkey finger presses for 'u' and 's', you just swap their positions in the table, putting the ASCII code for 's' (&73) into &1C4C, and the code for 'u' (&75) into &1C4D. It makes more sense to do something useful, like putting the SHIFT + function key codes into unused spaces in the tables: in my personalised version of *Prog* I have put &92, &93, &95 and &96 into locations &1C7C, &1C7D, &1C7F and &1C83 respectively. The Quinkey then produces the teletext colour characters for green, yellow, magenta and cyan when two thumb keys are pressed with one other key.



Four Quinkeys can access the Beeb simultaneously

One major way in which the Quinkey differs from the ordinary keyboard is in its handling of autorepeat. Because a character is put into the buffer only when the finger keys are released, no autorepeat takes place when the keys are held down. (If you are not sure what 'autorepeat' means compare this with the action of the BBC micro when you put your finger on a key and keep it there.)

A simulation of autorepeat has been put into the Quinkey, however, which works like this: if, after entering a character, all the keys are pressed including both thumb keys, the character last entered starts to autorepeat at about the normal default rate used on the main keyboard (5/100 second). This rate is not affected by *FX12 but can be altered by changing a byte in the Quinkey driver machine code at &1AAC. This is normally 5 (the second byte of LDA #5) but can be changed to 2 or 3 for a faster autorepeat.

The only keys that need to autorepeat on a regular basis are the four cursor keys, Copy, and perhaps Delete. I feel it would be nice if these keypresses, all of which are Quinkey 'command' shapes, could autorepeat just by holding them down for more than one

third of a second or so, at a controllable rate. Since the actual handling of the Quinkey input is done entirely by software, it is likely that improvements and enhancements like these (if such they are) will become available in due course.

One keyboard facility the Quinkey cannot mimic is the INKEY(-N) statement in Basic, or the equivalent OSBYTE call in machine code. These access the hardware connected to the keyboard rather than the input buffer, and cannot be intercepted through RDCHV: possibly they could be intercepted through BYTEV.

This is not a great problem so long as the Quinkey is considered a text input device rather than a games controller halfway between a keyboard and a joystick. However, I'm sufficiently enthusiastic about the Quinkey after a week of use to think that Microwriter can afford to set its sights as high as possible. It is conceivable, with advances in Very Large Scale Integration continuing, and tiny flat-screen TVs starting to make their appearance, that portable computers in ten years will be no larger than the Quinkey itself - and that is all you will need. If this prediction turns out to be true, the six-button keyboard is the interface of the future, and could be the death of qwerty sooner than anyone expects. Before that happens, we are likely to see Quinkeys linked to the computer by infra-red rather than wires, like the IBM PC keyboard.

Because the Quinkey has not been programmed to intercept INKEY with a negative argument, one popular feature of the BBC micro does not work from it. This is the use of the SHIFT key in scrolling listings in paged mode. Paged mode can still be switched on and off, since CTRL-N and CTRL-O are both characters the Quinkey can output. But once you are in paged mode, you have to press the SHIFT key on the keyboard to keep a listing going.

For a programmer (Basic or assembly language) this is a real disadvantage. The problem that the Quinkey is up against is that it really has to provide all the functions of the keyboard, without exception, if it is going to compete. It comes so close that it's a pity Microwriter didn't make sure of the paging facility at least.

You will probably expect me to finish by saying this article was typed using a Quinkey. It wasn't. I'm still a lot faster on the keyboard, and possibly always will be. Old habits are hard to kill. But I'm going to persevere with the Quinkey, if only to avoid developing the dreaded Hacker's Shoulder in my old age. And to be ready for the hand-held supermicros of the 1990s, of course.

microFAST LATEST BARGAIN PRICES

MONITORS

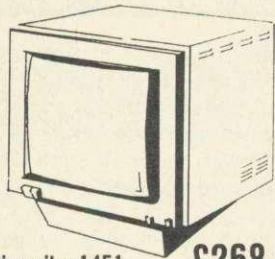

Microvitec 1451 **£268.69**
+ VAT = £309

Monochrome

Sanyo DM2112 **£75**
Sanyo DM8112CX **£103**
Teco with Zoom **£105**

Colour

Microvitec 1431 **£195**
1431 (RGB/PAL/Audio) **£225**
Microvitec 1451/1453QL **£309**
1451 (RGB/PAL/Audio) **£340**
Microvitec 1441 Hi resolution
Plastic case **£499**

DISK DRIVES

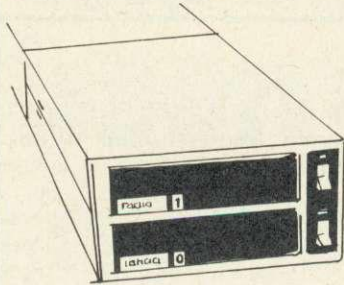

Special Offer 3" drives Zook
Single 40T **£185 inc VAT**
400K Dual 40T **£369 inc VAT**

Single

100 SD 40T **£127**
400K Mitsubishi 40/80T **£199**

Double

800K Cumana 80T **£409**
800K Mitsubishi 40/80T **£489**

Floppy Disks

3" **£4-50**
5 1/4" S/S 40T **£1-80**
5 1/4" D/S 40T **£2-10**
5 1/4" D/S 80T **£2-90**

TV/MONITORS

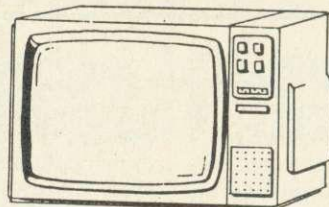

£280
inc VAT

ITT RL2301 **£280**

VARIOUS

Torch Ext. Processor
+ Software **£299**

Torch Ext. Processor
+ software + twin drives **£749**

Computer Concepts ROMs
from **£32**

Acorn Business Software **£24**

Acorn Data Recorder **£32**

Computer Work Station **£57**

Holds Micro *, Monitor, Printer
with Storage Space.

Printer Stands **£17**

Desk Stacking Unit **£23**

(Lockable version available)

DOT MATRIX

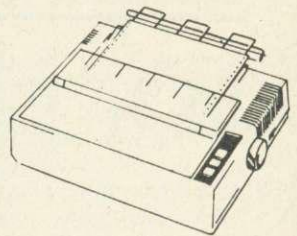

Epson RX80FT **£221.73**
+ VAT = £255

Star Gemini 10 **£249**

Star Delta 10 **£365**

KDC FT-5001 **£234**

Epson RX80 **£219**

Epson RX80 F/T **£255**

Epson FX80 **£379**

Mannesman MT80 **£225**

DAISYWHEEL

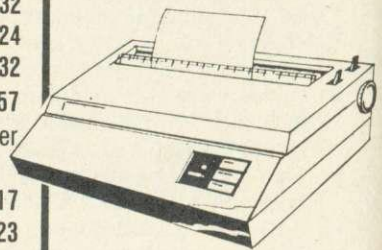

Juki 6100 **£326.08**
+ VAT = £375

JUKI 6100 **£375**

Silver Reed EXP500 **£315**

Daisy Step 2000 **£289**

Plus

JUKI Sheet Feeder **£239**

JUKI Tractor Feed **£109**

Serial Interface Conversions

8143—Epson **£30**

8148—Epson (2k buffer
XON/XOFF protocol) **£65**

JUKI **£55**

Plus cables from **£12**

PROCESSORS

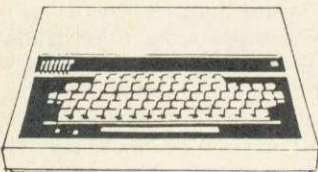

BBC Model B **£338.26**
+ VAT = £389

BBC MODEL B **£389**

BBC 'B' WITH DFS **£459**

Acorn Z80 Ext. Processor **£299**

Acorn Electron **£199**

Torch Unicorn Package **P.O.A.**

DISK INTERFACES

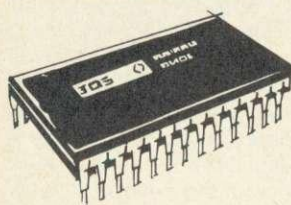

Kenda Mighty Oak **£90**

Kenda Professional (double
density) **£130**

Opus Double Density **£130**

Acorn DFS Kit **£97**

MODEMS

Selection of Acoustic couples
and Mini Modems in stock.

★ BT Approved

★ Portable Modems

★ Low Cost

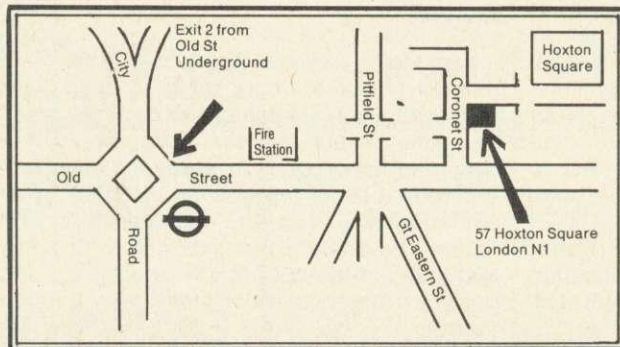

ALL PRICES INCLUDE VAT

Prices shown are for cash & carry sales and are correct at
time of going to press.

Export price list available

Mail order and credit cards accepted

OPEN 9-6 Monday to Saturday

57 Hoxton Square

London N1

Tel: 01-729 1778

BUSINESS SYSTEMS

A.C.T. Apricot
Processors and
Business Systems
assembled to your
specification. Price
dependent on
equipment supplied.
Call us to discuss your
requirement.

microFAST

THE EXPERTS

WATCH MY LINE

Chris Steele sees an educational potential in the Parfitt plotter

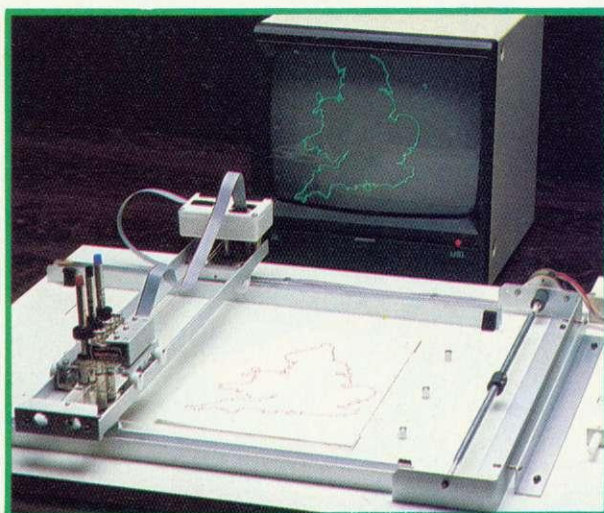

The plotter draws an outline map of Britain from a scanned image stored in memory and displayed on the screen

147

DESIGNERS tend to be particular about the quality of an image. Teaching 'computing in art and design' in an art college is not easy, and when the students realise that the final product is to be either a screen photograph or a screen dump they often lose interest altogether. But demonstrate a plotter drawing a grid

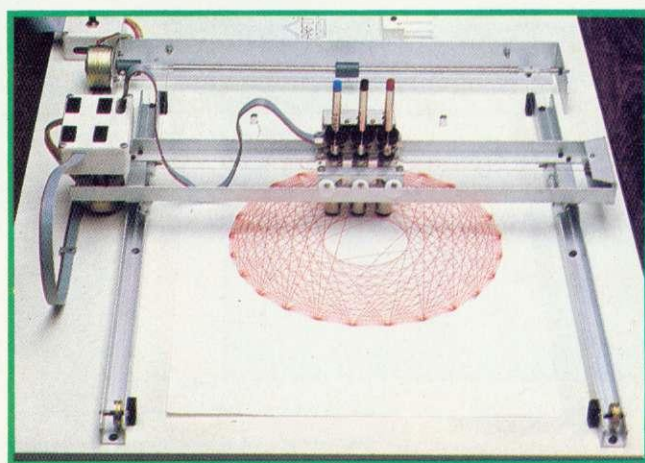

The plotter drawing under the control of a recursive routine

The Parfitt Plotter

Handwritten by the Parfitt plotter

with great accuracy and speed and interest is rekindled.

The important difference is that a plotter moves a pen across the surface of the paper, so creating a continuous line. This produces an image of vastly superior line quality to that produced by the pins of a dot matrix printer.

Plotters tend to be very expensive, so the introduction of a cheap A4 three-pen plotter by Parfitt Electronics will arouse a lot of interest in education (see prices panel, page 149).

First impressions are often deceptive and the Parfitt plotter proves no exception to the rule. At first it seems to be a prototype development model, with bare stepper motors and extruded aluminium section mounted on a laminate covered chipboard base – nothing is left to the imagination.

Once unpacked, the ribbon cable from the plotter is attached to the user port on the BBC and the power lead attached to either your micro or the external supply which Parfitt will supply. Three pens are supplied with

the standard kit to get the user off the ground.

The manual, which is quite sufficient for the frequent user, is carefully laid out.

Software is provided to enable the plotter to be used easily from ordinary Basic programs. This must be loaded before the plotter can be used.

Calls are provided for PMOVE and PDRAW as replacements for normal graphics commands, but also for PLINE (draw a line between two points), PBOX (outline a rectangular area), POFFSET (to move the origin), PINIT (reset the plotter), PORIENT (set the orientation of text), PSTRING (to print text) and PSPEED (to control the drawing speed of the plotter). The code takes up 1.5k of the memory.

Demonstration software is supplied on a menu-driven autoboot disc and you are encouraged to make a backup. Setting the plotter up is a bit of a drag. First, the pen guides, pens and pen-lifting rings must be carefully adjusted so that the pens are actually off the paper when the software thinks they are. The drawing medium must be firmly attached to the base so that it lies perfectly flat.

None of this is difficult – just time-

consuming and not something students seem willing to do.

The plotter is provided with three coloured fibre-tip pens, but Staedler drawing pens can also be accommodated. In practice we use many types of material, from acetate to line board, to draw on. Different thicknesses of paper, though, require the pens to be set to different heights – more frustrating minutes sliding the lifting arms up and down the pens.

Like most plotters, the Parfitt plotter

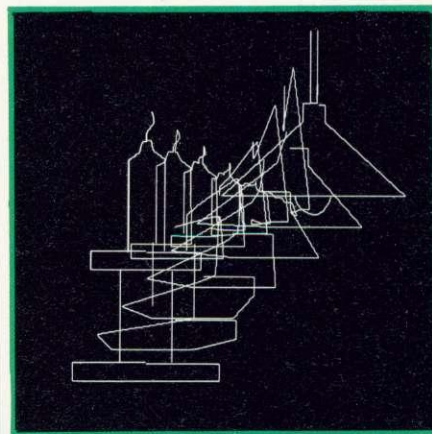

Scraper board design by the author, cut with scriber

Start with EPSON's best...

... add a sturdy,
power-supply upgradeable case,
test it thoroughly, package it
with all necessary
leads and manuals,
and add a full year's
warranty:

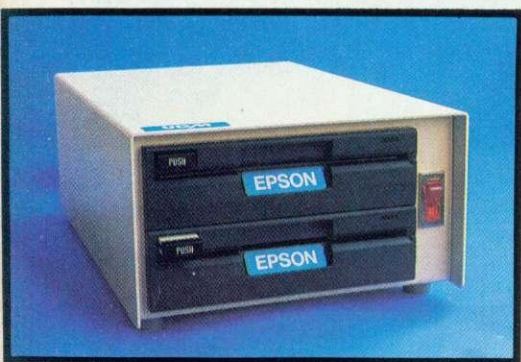

The UDM Disk Drive!

Available through UDM dealers,
in single & dual, 40 & 80 track
single & double sided, 5¼ & 3½ inch
versions with or without power supply
for less than you think.

Please forward me details on
the Epson/UDM range.
I am interested in becoming
a UDM Authorised Dealer.

Name _____

Address _____

UNITED DISK MEMORIES

STANHOPE HOUSE FAIRBRIDGE ROAD LONDON N19 3HP 01-263 5026

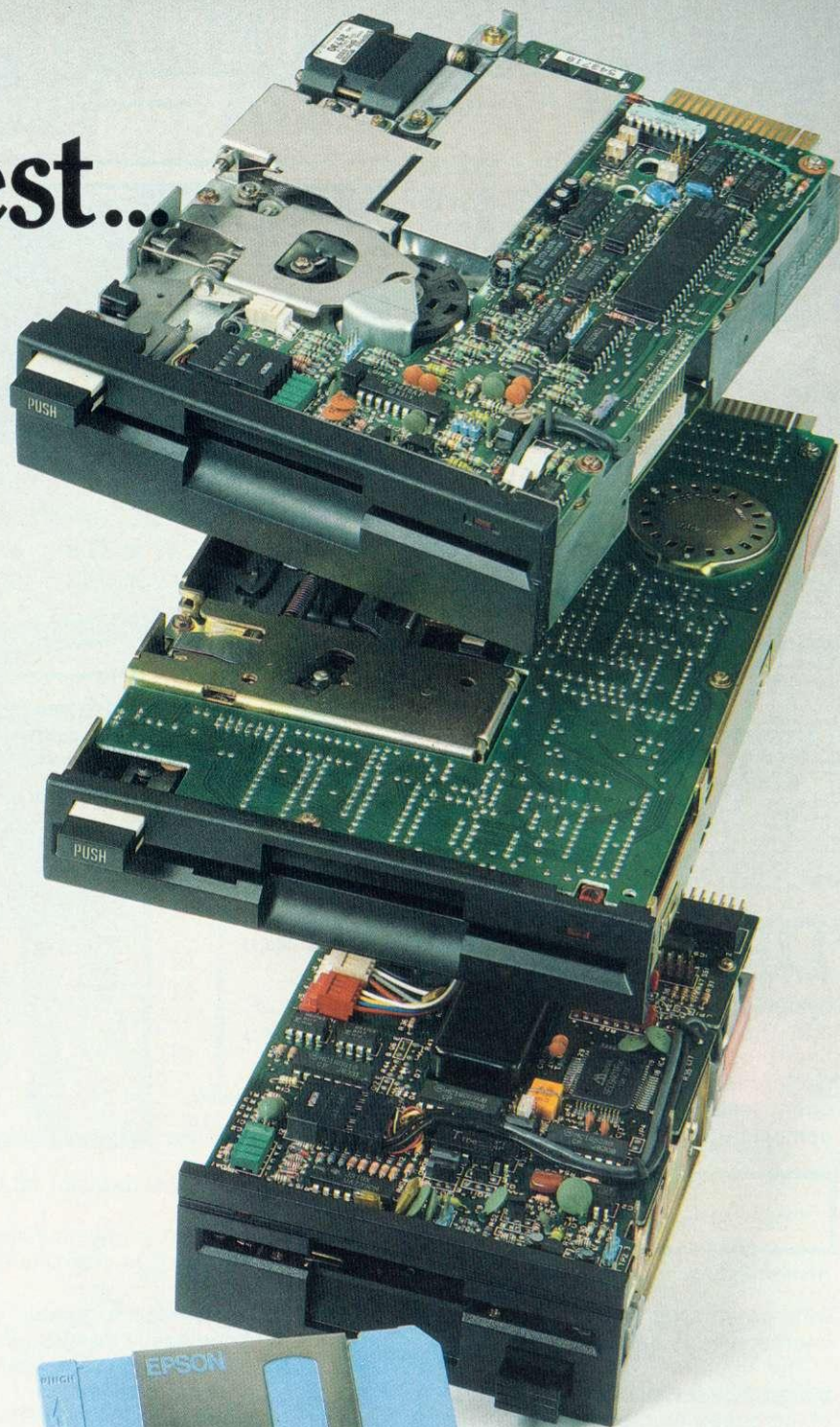

DESIGNS THAT DELIVER
UDM

drives the pen across the drawing surface with two stepper motors. It is the size of each discrete step the motors take that determines the quality of the line produced. Even with the best plotters, costing a hundred times the price of the Parfitt these steps are discernible at close range by the jaggedness of the line. The step size on the Parfitt is 0.25mm, which produces noticeable steps in all but horizontal and vertical lines.

The Parfitt has performed very well at Canterbury College of Art, proving robust and dependable. (In education 'robust' can be translated as 'tank like' when you consider the unintentional abuse which students subject equipment to.)

Graphics students have used the plotter to develop simple grids for page layouts and plots on which to develop their ideas at home. Drawing grids manually can be so frustrating that seeing the plotter in action prompted one graphic designer to proclaim that he now had all the reason he needed to buy a BBC computer!

Both software and hardware appear to be under constant development. A 'soon to be launched' triple software pack will include a Logo implementation, a 'pottery' or 'glass' design pack allowing simple forms to be rotated (this will look familiar to users of Gino) and a 3D package (which looks very much like one I first saw on the 380Z).

On the hardware side there is now a scriber that can be used with scraper-board, an opto-sensor for scanning images, and a drill/router for cutting into a material. A combined kit could (with the right software) allow an image to be input from paper, manipulated on screen, and then drawn, scribed or cut out by the plotter. The present software takes 20 minutes to scan an image, which is a drawback.

Parfitt Electronics believes that 95 per cent of its market is in the education field.

I doubt that there are many personal users willing to pay for a plotter. However, there is nothing like this product on the market at the moment—the MCP40 plotter can use only 4 in. wide paper and the Data Efficiency strobe graphics drum plotter is nearly twice the price.

I believe the most useful application of the Parfitt plotter is as a demonstration tool. Out go the dreary slides of computer drawings or computer controlled machinery, in comes a Parfitt plotter.

It visibly demonstrates how a computer can control the physical world, and in this respect its naked appearance is an advantage. Students can see everything working.

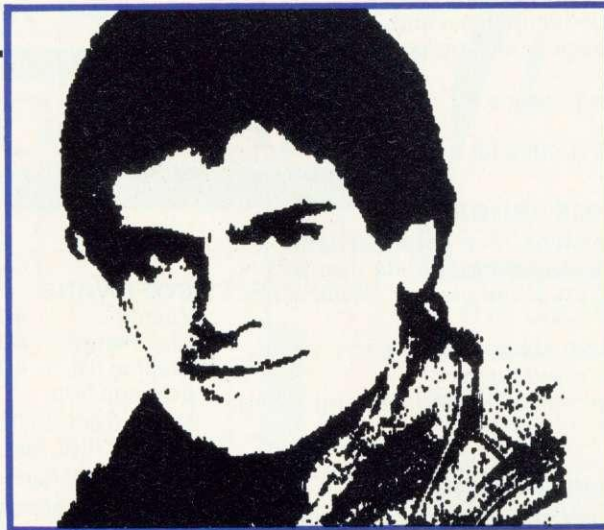

Photograph digitised by the Parfitt plotter's opto-sensor, then dumped back onto the plotter using the software provided

149

At first glance the Parfitt plotter looks like a prototype development model, with bare stepper motors and a laminate chipboard base—but its nakedness is actually an advantage in demonstrations

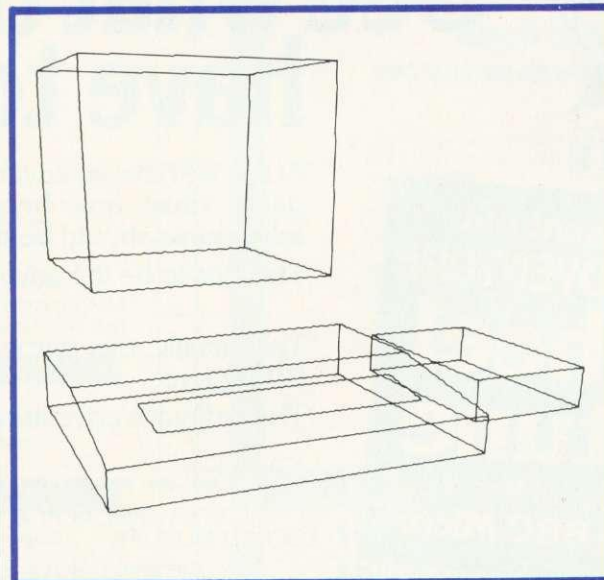
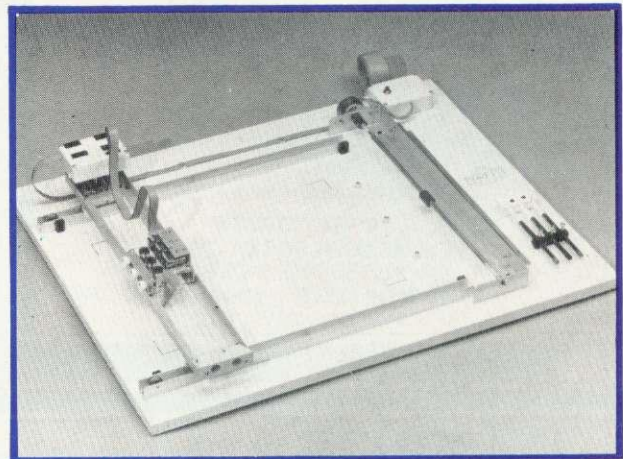

Three dimensional plotting (left and below) of the Beeb, monitor and disc drive, produced from the author's own software

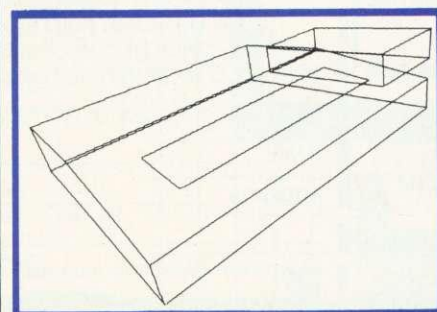

PRICES

Basic plotter, software, pens, manual and delivery	£270
Software on disc (extra)	£4
Power supply cable	£3.50
Basic power supply (PS12)	£42
Power supply for plotter and drill (PS24)	£78
Opto-sensor	£74
Staedtler pen set	£22.50

All prices exclude VAT

BBC DUAL DISC PAYROLL PROGRAM

For 150 employees with 100K disc using random access operation.

Calculates most tax codes and national insurance rates. Calculates up to 24 fixed deductions per employee including employer's and employee's pension contribution and S.S.P.

Prints payslips, cheques and cheque list.

Has coin and note analysis.

Has a complete end of year routine for tax returns.

BBC B DISC MAIL MERGE PROGRAM

Produces personalised versions of a standard letter by merging names and addresses held on a data disc with a standard letter produced on Wordwise or Merlinscribe word processors.

Prints letters, envelopes, two abreast labels and the complete file including telephone numbers.

Comprehensive facility for selecting and printing using any user definable criteria.

BBC B DISC MAILING LIST PROGRAM

Stores up to 350 names and addresses per 40 track disc or 700 per 80 track disc.

Incorporates comprehensive search facilities for selective printing of labels, envelopes and letter headings.



MICROS

BBC B £395 + DFS £469
Electron £199
Spectrum £125

MONITOR

Colour/Green Novex 1414 £228
Green Sanyo DM2112 £80

PRINTERS

RX-80 £290
RX-80 F/T £325
Gemini 10X £255

DISC DRIVE

Single 40 track 100K £170
Single 40/80 track 100K £299
Dual 40 track £350
Dual 40/80 track DS £575

SOFTWARE

Payroll :- 40 or 80 track £49.95; Torch Z80 £74.95
Mail merge :- 40 or 80 track £39.95; Torch Z80 £69.95
Mailing list :- 40 or 80 track £19.95; Torch Z80 £29.95
Carriage 50p.

Discs from £19.95, cassettes from £0.55 and joysticks from £17.50, leads from £2.50.

Just arrived hard covers for all micros.

Business systems customised to individual needs such as word processing, payroll, employment agencies and chemist.

All prices inc VAT. Postage extra.

SEND ORDERS TO

CYB COMPUTERS

9 Crown Parade, Crown Lane, Morden,
Surrey SM4 5DA. 01 542 7662.

WE ARE A FEW YARDS FROM MORDEN UNDERGROUND STATION



We proudly present our
NEW GRAPHIC ADVENTURE

The Wheel of Fortune

... widely regarded as the best
available for the BBC Micro

This game is a classic puzzle adventure with all the features you'd expect from EPIC

- HALF SCREEN FULL-COLOUR GRAPHICS FOR EACH OF THE 250 LOCATIONS
- INTELLIGENT MOVING CHARACTERS ACTING IN REAL TIME
- MULTI STATEMENT LANGUAGE AND SPEECH INTERPRETERS

See what the experts have to say...

"At last we have an adventure worthy of the BBC Micro... This game must now become a yardstick by which future adventures should be measured." *MICRO ADVENTURER*

"This has to be the adventure of 1984. It really is superb." *MICRONET 800*

"Technically, this game surpasses any I have seen for the BBC Micro." *H.C.M.*

"The definitive adventure. Highly recommended." *ELECTRON USER*

TO: EPIC SOFTWARE, DEPT. A, 10 GLADSTONE ST., KIBWORTH BEAUCHAMP, LEICESTER LE8 0HL *Please Rush Me-*

	CASSETTE	DISC	STATE: BBC/ ELECTRON (Delete)
.....qty THE WHEEL OF FORTUNE	£9.95	£11.95	
.....qty CASTLE FRANKENSTEIN	£7.95	£9.95	
.....qty THE QUEST FOR THE HOLY GRAIL	£7.95	£9.95	
.....qty THE KINGDOM OF KLEIN	£7.95	£9.95	

POSTAGE & PACKING FREE FOR 2 OR MORE. ADD 50p FOR ONE.

I ENCLOSE CHEQUE/P.O. TO THE VALUE OF

NAME

ADDRESS

POST CODE

All programs available for immediate despatch. Dealer enquiries welcome. Help Service.

THE PRINTED WORD

LOW PRICES

TOP SERVICE

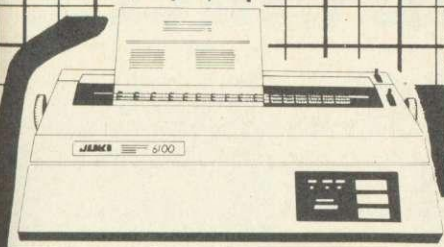

JUKI 6100

One Year Warranty
 20 CPS : BiDirectional & Logic Seeking
 10, 12, 15 & Proportional Spacing
 Wordstar Compatible
 2K Buffer : 13 Inch Platen
 Underline : Backspace + Lots more
 Centronics Interface Standard
 RS 232 Interface £54.00 + VAT Extra
 Tractor Feed £99.00 + VAT Extra
 Single Sheet Feeder £238.00 + VAT Extra

JUKI 6100 £347.83 + VAT = £400.00

BBC/ORIC or DRAGON Package
JUKI 6100 + CJE PRINTER PACKAGE
£420.00 Inc. VAT



CANON PW-1080A

Near letter Quality Printer

NLQ Mode 23 x 18 Matrix: 27 cps
 Draft Mode 11 x 9 Matrix : 160 cps
 Full range of Epson FX 80 Print Codes
 Friction & Tractor Feed
 Centronics Interface Standard
 CANON PW-1156A (Accepts 15" Paper) Available

CANON PW-1080A £295.65 + VAT = £340.00
CANON PW-1156A £391.30 + VAT = £450.00

PACKAGE PRICE for BBC MICRO/DRAGON/ORIC
CANON PW-1080A C.J.E. PRINTER PACKAGE £365.00 Inc. VAT
CANON PW-1156A C.J.E. PRINTER PACKAGE £470.00 Inc. VAT

Special RS 232 Printer Bargain

STAR DP8480 (8" Printing) £197.00 Inc. VAT
 Ideal for BBC/Newbrain/HX20 & Spectrum Int. 1
 Phone for full specification

C.J.E. Micro's BBC Printer Packs
 For Star, Canon & Juki Printers include:

1. The Printer
 2. Delivery by Securicor
 3. Cable to the BBC 1.3 Metres
 4. Screen Dump Program (M/C Source)
 5. Text Dump Program
 6. Function Key set up Program. For use with WORDWISE
 7. Function Key Label Printing Program. For use with above.
 8. VIEW Printer Driver
 9. 100 Sheets of Paper
 10. Mains Plug with 3 Amp Fuse
 11. Booklet giving details of using the printer with a BBC.
 12. Character Defining Program for Downloadable-character-set
- C.J.E. Printer Packs for other micro's include:-
 Printer, Cable, Paper, Mains Plug & Delivery

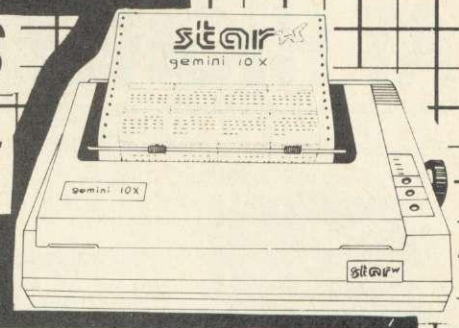

STAR GEMINI 10X

One Year Warranty
 True Descenders 9 x 9 Matrix
 120 CPS Bidirectional & Logic Seeking
 40, 48, 68, 80, 96, 136 cpl
 Italics, Emphasized, Double strike,
 Super & Sub Scripts
 Downloadable Character Set
 Hi-Resolution & Block Graphics
 Friction or Tractor Feed
 10 X 10" Carriage, 15 X 15" Carriage
 Centronics Interface Standard
 RS232 Int. £52.00 + VAT Extra

Gemini 10X £235.00 Inc VAT
 Package for BBC/DRAGON/ORIC
GEMINI 10X + CJE Printer Pack £255 Inc. VAT
 Star Gemini 15X £390 Inc. VAT

STAR DELTA 10
SPEC. AS FOR 10X PLUS:-
160CPS: 8K BUFFER
CENTRONICS + RS232 INT'S STD
£320 + VAT = £368.00

BBC MICROMODEL B £399.00 Electron £199.00

BBC Micro Model B with Disc Int. £469.00

Large Range of Accessories including Disc
 Drives, Printers, Monitors always in stock.

Printer Cables

BBC to 36 Way Centronics Type Connector £15.00
 Dragon to 36 Way Centronics Type Connector £15.00
 Oric to 36 Way Centronics Type Connector £15.00
 Torch to 36 Way Centronics Type Connector £20.00

Serial Printer Cables

BBC to 25 way D type £9.50
 EPSON HX20 to 25 way D type £9.50
 NEWBRAIN to 25 Way D-Type £12.00
 25 way D type to 25 way D type £15.00

Blank C15/C30 Cassettes Ten for £4.50 ANY MIX
 Send SAE for Full Price List

VAT INCLUDED WHERE APPLICABLE
PHONE/CREDIT CARD ORDERS WELCOME

Postage 50p per order or as stated
 24 Hr Securicor Delivery
 for Printers/Disk Drives £8.00
 (SHOP/WORKSHOP CLOSED MONDAYS)

C.J.E. Microcomputers

Dept (PCW), 78 Brighton Road, Worthing
 W. Sussex BN11 2EN (0903) 213900

EXPORT ORDERS WELCOME

RING FOR SAMPLE PRINTOUT, FULL SPECIFICATIONS & LATEST PRICES
BEST PRICES & BACKUP ON THE STAR JUKI & CANON PRINTERS

HIGH QUALITY COMPUTER DESKS AT HIGHLY COMPETITIVE PRICES.

THE ORGANISER DESK.

- Top shelf for monitor/printer.
- Large desk top area.
- Lower shelf for paper/book storage.
- Teak finish • On castors.
- Self assembly.
- Ample room in front of the shelf for you to sit comfortably.
- Assembled Dimensions: H.31" W.40¼" D.26"



Only £59.95.

THE APOLLO RANGE OF BUSINESS DESKS.

- 10 models available to suit leading computer systems. • Immediate delivery.
- Sturdy steel underframes.
- Scratch resistant surfaces.
- Lockable castors. • Prices from £100.

All are on display in our showroom and are available from us or dealers throughout the U.K. All prices include VAT and delivery.

For further details contact us at:

158 Camberwell Road, London SE5 0EE. Telephone: 01-701 8668.

Opus.
Opus Supplies Ltd.



Eprom Programmer for the BBC Micro

This compact, elegant unit programs 2764 & 27128 eproms and offers the following attractive features.

- high quality, low cost
- menu driven software incorporating the following commands: program, save, verify, testblank, checksum, select eprom, MOS call, ROM format
- optional conversion from Basic to ROM format
- free 2764 eprom containing programming software – no cassette loading problems
- easy to use 28 pin zero insertion force socket
- built-in voltage converter
- integral cable connecting to user port; no other connection needed
- comprehensive documentation plus one year's guarantee.

This product is available in quantity NOW!

Programmer and data sheet from Softlife Ltd.,
87 Silvertown Way, London E16 4AH Tel: 01 474 0330

Copyrite

This Disc Back-Up Utility for the BBC Micro will recreate all protected software so far encountered.

Copyrite

requires a BBC 'B' with operating system 1.0 (or later) and any Acorn compatible DFS. It is available in 40 - 80 track versions. Copyrite cost £10.95 inclusive of postage and packaging. Cheques payable to Ephagy Software Products or send an LEA purchase order.

Copyrite

is incapable of recreating itself due to a sophisticated protection system. Now we can offer you this system of protection. Write now for further information about our Disc-Minder service.

WARNING This powerful package is not intended to be used to break copyright. It is capable of duplicating most protected disc based software and as such must be used with discretion.

Ephagy Software Products
Rear of 125, Corporation Road,
Grimsby South Humberside DN31 1UR

YOUR STARTER

FOR NUMBER TEN

'1984', Incentive Software, BBC B, £6.50

NOT, as you might think from the title, the latest arcade game with Winston Smith being pursued by man-eating rats and Thought Police. Instead *1984* is about the rather more mundane task of running the nation's finances, with you as Prime Minister.

Using the 1982/83 economic figures as a basis, you have to decide on the levels of Government spending, income tax rates and wage settlements for 1984. Unless you make a complete mess of the first year and are forced to resign, you can then go on to balance the books for subsequent years – the ultimate goal being to stay in office until the 21st century.

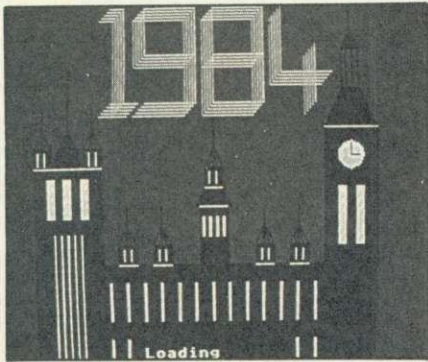

The program itself is loaded using four different sections – an increasingly common device designed to stop piracy. The first section – the 'loader' – draws a rather nice Houses of Parliament and then, to the chimes of Big Ben, loads in the rest of the program. The next thing you see is the Government's balance sheet showing expenditure and revenue. For 1982/83 these balance at £140bn and ideally they should balance each year. Then you get the eight major economic indicators: inflation rate, unemployment, gross domestic product, gold reserves, industrial output, balance of trade, average wage and exchange rate. Together these show how the economy is faring each year, but you can also see a graph of how each indicator has changed during your years in office.

At the beginning of each year, the first thing you have to set is the Minimum Lending Rate, which affects bank interest rates. Only small changes are allowed, so if it stands at 9 per cent you can't change it to 5 or 20 per cent – the effect on the economy would be devastating!

Next you negotiate the year's wage

settlements for the Civil Servants, the Public Sector and the Private Sector. Outlandish settlements are not allowed: if the Civil Servants ask for 8.7 per cent and you offer 100 per cent you will be forced to resign – end of game. On the other hand, if you offer only 2 per cent, such a derisory figure will be rejected and their claim will go through. Unlike real life, though, you only get one round of bargaining.

The level of funding for the various Government departments is decided next, and this is where party policy can be put into practice. You might, for example, want to increase spending on Social Security and Housing at the expense of Defence and Transport. You cannot make really drastic cuts, and if any departments are seriously underfunded a warning message appears. Huge increases will be greeted by the message 'Public Spending out of Hand' and again you will be forced to resign.

Next you temporarily become the Chancellor. In your Budget you can

raise extra money from VAT, income tax etc, or increase unemployment benefit, child benefit etc. I noticed a rather drastic bug here: if you reduce any of the tax rates – VAT for example – to zero, it cannot be raised again, because you cannot increase any rate by more than 10 per cent and a 10 per cent increase on zero is still zero!

If you survive the year you get an opinion poll of your popularity; if it falls below 45 per cent you're in trouble! Before going on to 1985, you can see the balance sheet and major indicators showing how well you managed 1984.

Playing *1984* gives you quite an insight into how the country's finances work. For example, it is very difficult to stop inflation spiralling away – from an initial figure of 4.8 per cent I had it topping 20 per cent by the end of 1986. Included with the program is a little booklet entitled 'A Pocket Guide to Running Britain'. Perhaps a complimentary copy should go to 10 Downing Street?

Geoff Nairn

SHOOT THE MEANIES ...

AND HOME TO MOTHER

'Cylon Attack', A&F, Unit 8, Canalside Industrial Estate, Woodbine Street East, Rochdale, Lancs OL16 5LB, BBC and Electron, £7.90

A COUPLE of years ago (when my Beeb was still a figment of the postman's imagination), I started to daydream of a computer game where you could fly a mission in space by being launched from a space station, fly around attacking three dimensional nasties and then fly back to dock with the mothership again. Later that same year Buck Rogers started doing just that and now A&F has gone a long way towards providing my original dream at the comfort of my own keyboard.

To play, you launch from your mothership into space, the blackness of which is interrupted only by the distant galaxies and the occasional advertisement for A&F. Almost immediately aliens start attacking, zooming in larger and larger and firing at you. Your own bolts may be discharged by pressing the space bar – A, Z, <, > and *, ?, Z, X control options are provided, plus joysticks – and, if on target, the ship disappears in a cloud of space debris. If you eventually hit a sector of space where there are no meanies around to take shots at you, your long range scanner, immediately above your cockpit view, can be used to search for others. If you destroy everything in the current attack wave, you have to

search out your mothership and redock to replenish fuel and shield energy.

There are two types of alien on the first wave, rising to four by wave three, and they all grow more numerous and aggressive as you progress. One type even spawns another, so that the enemy may replenish its forces during an attack.

You may refuel during an attack wave (and at the higher levels you will

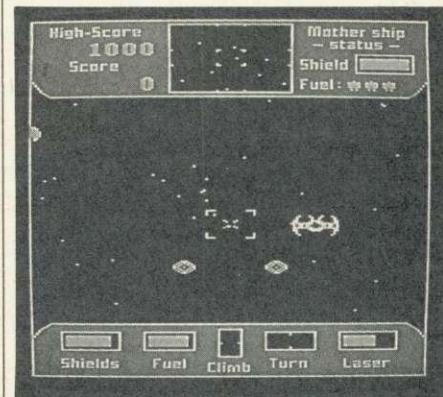

be forced to), but all the alien's venom will then be concentrated on your mothership. Loss of all shield energy (or destroying your own mothership) signals the end of the game.

Cylon Attack is as good a space game as you're going to get on the BBC micro at the current state of play.

Simon Williams

START PROFESSIONAL —STAY PROFESSIONAL

For the BBC Micro Model A/B

MORTGAGE ANALYSIS

More than a repayment calculator it provides clear tabular information that makes sensible analysis of your mortgage investment particularly easy with inflation, tax relief and increasing house prices all being taken into account. In the present climate of changing interest rates this is an essential aid to planning your finances.

Code (Tape) WA5 Price £10.95 Code (Disc) WA6 Price £12.95

For the BBC Micro Model B with 40/80 SS/DS disks

MULTIPLE DISC CATALOGUE

Used with either Wordwise or View, insert discs one by one to produce a complete and fully sorted catalogue of your whole diskette library. This can be edited, printed or formatted in any manner you wish. Now included with the MDC is our disc backup and verification utility which greatly assists the necessary task of making secure backup copies of your diskettes.

Code WA3/4 Price £8.50

AUTO SELECT

This provides a professional screen layout with fast automatic menu production from which software may be automatically loaded (CHAIN/*RUN/*LOAD/*EXEC). Extensive use is made of pre-programmed function keys which enable ROMs to be selected easily. Both single and double sided drives are supported as are multiple disc units.

Code WA1 Price £8.50

PROGRAM DEVELOPMENT

This provides very flexible control of the Screen/Printer together with formatted listings (indents and splits multiple statement lines). Extensive use is made of function keys to give Auto-List of Error Lines, Easy Program LOAD/SAVE/VERIFY etc.

Code WA2 Price £8.00

When ordering WA1, WA2, WA3/4 add £4 to total order price to cover cost of diskette (state 40/80 tracks), post and packing. Price of WA5 and WA6 already includes cost of media and package.

To Order: Phone 029671-4679 or 0908-641327, or write to:

WALTON ASSOCIATES

2 Red House Close, Newton Longville, MILTON KEYNES MK17 0AH

SAY GOODBYE TO GOTO!

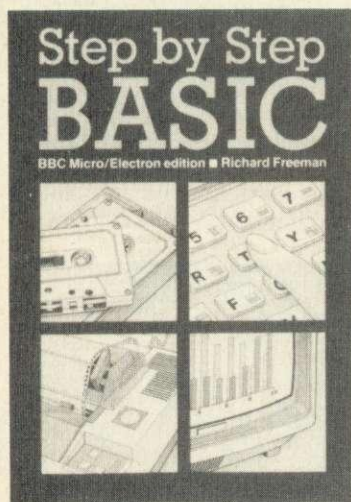

And to the bugs and the spaghetti! With Step by Step BASIC you learn to write well-structured programs from day 1. Programs that work and that you can see will work. Colour, sound, graphics, files, sorting all included.

BBC/Electron edition (203 pp)	£5.95
BBC/Electron program tape	£5.50
ZX Spectrum edition (177 pp)	£5.95
ZX Spectrum program tape	£5.50

LIFELONG LEARNING LTD
Dept AU, 55 MILTON ROAD
CAMBRIDGE CB4 1XA

MAKE THE MOST OF YOUR COMPUTER.

INTERFACE PUBLICATIONS

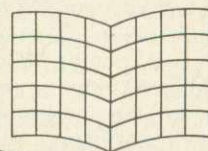

Acclaimed books from the experts . . .

- Dynamic Games for your Electron
Neal Cavalier-Smith. £4.95
- 36 Challenging Games for the BBC Micro
Chris Callender and Tim Rogers. £5.95
- Let Your BBC Micro Teach You to Program
Tim Hartnell. £6.45
- Putting Your BBC Micro to Work (includes a full
word-processing program, plus 14 others)
Chris Callender. £4.95
- Creating Adventure Programs on your Computer
Andrew Nelson. £4.95
- The Easy Way to Program Your New Computer
Tim Hartnell. £3.95
- Practical Applications for the Microcomputer
in the Home.
David Hole. £4.95
- The Art of Structured Programming
Peter Juliff. £5.95

These books are available from most book and computer stores. In case of difficulty, order directly from us.

Interface Publications, Dept. QAU,
9-11 Kensington High Street, London W8 5NP.

Please send me the indicated books. I enclose £ _____

Name _____

Address _____

INTERFACE PUBLICATIONS



We're the Experts.

(TRADE ONLY: Interface Publications are distributed exclusively in the UK and
Ireland by W H S Distributors. Export trade handled by Interface Publications.)

O WELL

OF FORTUNE

'Dallas', Cases Computer Simulations, BBC B and Electron, £6.95

YES, your worst thoughts have been realised – a game based on the wheelings and dealings of everyday oil folk in Downtown Dallas. You are head of your own oil company and the aim of the game is to accumulate \$200m and so buy out the dreaded Euings – note the subtle change in spelling.

On the screen is a map of Texas and you have to buy up various plots – 'concessions' – so that you can drill for oil. Seismic surveys tell you whether there's any oil in your concession, and if there is you then have to build rigs, production plants and pipelines to get the precious stuff out of the ground.

You start out with \$100m in cash but a few fruitless surveys and unproductive wells can soon have you in debt, at which point you fall prey to a takeover from the Euings. Actually, they seemed to buy me out no matter what action I took: obviously I'm not the material of which oil barons are made.

One major drawback of the program is that new concessions are offered for sale at pretty infrequent intervals. If you don't have any wells producing, there's nothing to do but wait for a concession to flash up on the map.

Another gripe: the inlay card's loading instructions say 'Type CRUN "DALLAS" to load program'. Not on my Beeb you don't.

There are good serious business games available for the Beeb, and there are exciting 'fun' simulations. Unfortunately Dallas is neither – though it does play a rather good version of the Dallas signature tune. **Geoff Nairn**

REFLEX

ACTION

'Fortress', Pace, BBC B, \$8.95 (disc £11.95)

FORTRESS is an excellent version of the arcade dazzler where you pilot a plane over a hostile landscape, shooting everything in sight before it gets you.

It's really a 3D version of the *Rocket Raid* genre and represents the best so far in the use of hardware scrolling. The ground is blue, and on it is the shadow of your own craft – which is the only clue to your height above the ground.

Fuel is in very short supply, so you must shoot up the enemy supplies to increase your own stocks (?).

The enemy appears in the form of rockets launched from silos, planes which sit around waiting for you to come to them, ack-ack batteries and various solid obstacles such as walls.

Controls are well laid out, with options for joystick, freezing the action, sound on or off, and even to alter which keys control what.

Loading presented problems, however. First a disc loaded would run, but then the screen scrolled and wouldn't stop. A cassette copy loaded well, but then crashed after a few goes. Two out of two duff copies is a bit off. Pace has got a winner here, and it's a pity the loading problems delayed my review, and stopped me getting too far into it.

Fortress is a reflex game, but a rather superior example. If you fancy yourself as a Bobby Dazzler of the keyboard, you'll want it. **Tony Quinn**



ROCK WITH

THE CAVEMAN

'Frak!', Aardvark Software, BBC B (OS1.2), £8.90

FRAK! introduces a new word into the vocabulary of Beeb users. It's one of those words you use when a favourite game won't load from tape, but has been coined originally by the caveman hero of this gem from Aardvark.

He shouts it out in a large yellow bubble whenever he falls from the grassy sods and ladders that it is your task to keep him on, gets pricked by one of the arrows falling from the sky, bumps into a monster – or is hit by a rising pink balloon. Such are the dreadful fates awaiting him, at least in the stages of the game I reached. It's a shame he never actually shouts his word from the Beeb's speaker, but then perhaps he does later on.

The outstanding thing about all this is the graphics. Sprites are used with gay abandon, and they're the best little sprites you ever did see. The charac-

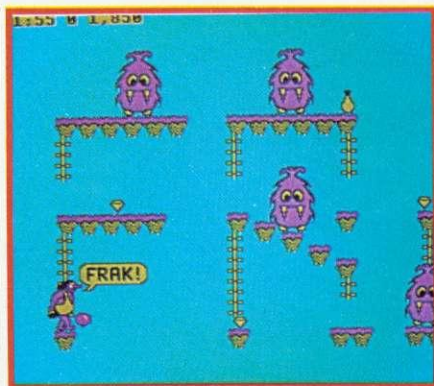

Our hero, struck by a rising balloon, utters his favourite curse...

ters could have stepped right out of a Disney movie from the good old cartoon days.

And when your alter ego gets one of the monsters with his only weapon (no, it's not a wooden club), the baddie goes shooting off the screen. Exit right in the extreme!

Frak! represents one of the new wave of BBC games that are at last living up to the machine. It is well-crafted, amusing, and, if not totally original, is a very far step from its ancestors.

Only two gripes from this reviewer. First, had I known the word *Frak!*, I would have used it several times trying to load the game from cassette. I loaded *Fortress* and a couple of others with no hassle, but this one took about 10 tries. (To give Aardvark its due, the company promises immediate free replacement to anyone who can't load the game.)

The other gripe was trying to ring them to announce my (not very) high score and find out the real high ones. The line was engaged on eight tries over 10 hours.

Frak! will flog and flog. Go out, buy it, put the Aardvark services to the test if you're unlucky with your copy. This is a classic, and who knows, a first edition might be worth a few bob one day.

Tony Quinn

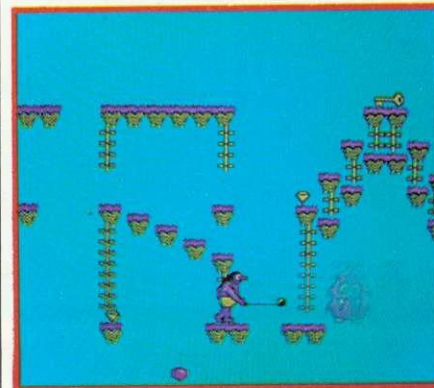

... But now he wields his deadly yo-yo, and a monster just f-f-fades away

SPECIAL OFFER!
Deduct £1 per cassette when ordering 2 or more.

TOP QUALITY SOFTWARE FOR THE ACORN ELECTRON

ACORN ELECTRON

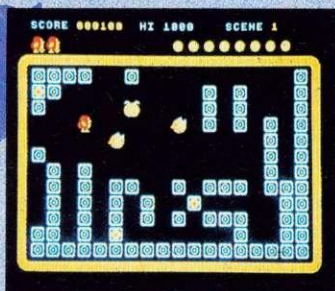

PERCY PENGUIN £7.95
The best version available for the Electron micro. Percy is trapped in an ice maze which is populated by the deadly Snobees. His only hope of survival is to squash them by hurling ice cubes at them. Unfortunately, whenever it seems that he has won, a deadlier breed appears. Hi-score, rankings, excellent graphics and sound.
NEW RELEASE



MR. WIZ £7.95
From the author of Percy Penguin, Mr. Wiz is a fast-action multi-scene game. Guide Mr. Wiz around the garden to eat the cherries whilst avoiding the evil gremlins. The gremlins can be killed by dropping apples on them or by throwing the crystal ball. Extra points can be gained by eating the magic mushroom, but beware...this is the home of the gremlins and makes them permanently furious! Sound effects and tunes, hi-score, rankings. Superb arcade-style action.
NEW RELEASE

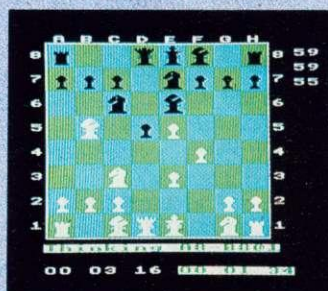

CHESS £7.95
A highly versatile implementation of Chess. Play black or white against the computer or a human opponent. The skill level of the computer's play can be varied widely, and moves are entered either by co-ordinates, cursor control, or joystick control. Moves can be taken back if an error has been made, and the board can be modified at any time. Games can be "saved" or "loaded", and the last game can be replayed. The computer will, if requested, suggest your moves.
NEW RELEASE



CENTIBUG £7.95
The centibug descends from the top of the screen weaving intimidatingly between the mushrooms. Your objective is to shoot all the segments of the centibug before it reaches the bottom of the screen.
Features include: spiders, snails, flies, 6 skill levels, hi-score, rankings, and increasing difficulty.



ALIEN DROPOUT £7.95
A novel and unusual program. Arcade-action with this exciting multi-stage shooting game. The objective of the game is to shoot the aliens out of their "boxes" before the "boxes" fill up. Once full, the aliens fly down relentlessly, exploding as they hit the ground. The game features include: 6 skill levels, rankings, hi-score, increasing difficulty.



STRANDED £7.95
An adventure game using hi-resolution full-colour graphics. You are stranded on a strange planet, and your mission is to return to civilisation and home. Many of the locations are shown graphically, including the spaceship, the cliffs, the mountains, and (if you succeed) your home. You must carefully explore your environment searching for hidden clues to help you in your quest.
NEW RELEASE



WORLD GEOGRAPHY £7.95
This program covers 166 countries which are divided into 8 categories of difficulty. Each country is pinpointed on an accurate, hi-resolution screen map of the world, and the user is asked the capital and/or population. At the end of the test, the percentage of correct answers is given, so that the student can monitor his geographical knowledge.

ALSO AVAILABLE:

INVADERS	£7.95	DISASSEMBLER	£7.95
FRUIT MACHINE	£7.95	DRAUGHTS	£6.95
CONSTELLATION	£7.95	REVERSI	£6.95

DEALERS - Our software is now available at all good dealers including: selected branches of W. H. Smith and Boots; all major computer dealers - Microstyle, Electronequip, 3D Computers, Computerama, GTM Computers, etc.; and our software is also available through all the major distributors, and directly from us.

WE PAY UP TO 20% ROYALTIES FOR HIGH QUALITY BBC MICRO AND ELECTRON PROGRAMS.



SUPERIOR SOFTWARE LTD.

Dept. AU9, Regent House,
Skinner Lane, Leeds 7
Tel: 0532 459453

OUR GUARANTEE

- (1) All our software is available before we advertise.
- (2) All our software is despatched within 48 hours by first-class post.
- (3) In the unlikely event that any of our software fails to load, return your cassette to us and we will immediately send a replacement.

FAST AND

FURIOUS

'Overdrive', Superior Software, BBC B (32k), £7.95

IF you've ever fancied your chances in a Formula 1 car race, *Overdrive* may give you something of the feel of being behind the wheel. You have four basic controls over the Ferrari-red vehicle at the base of the screen: to steer left and right, accelerate and brake. These are smooth and responsive and the illusion of movement created by the flashing white kerb-markings is fairly effective.

The main challenge throughout the five stages of the race is to avoid the other cars as you overtake them. The number you overtake depends on your speed, which can rise to more than 200mph. This is clocked up on an attractive LED-style display at the top of the screen, along with your score, bonus points and the time remaining for the current stage. If you haven't achieved a high enough position on the grid, you can't advance to the next stage. You are very vulnerable if you collide with another car, since this seems a heaven-sent opportunity for



every other driver in the race to plough into the back of you before you have time to pick up speed again.

In the first stage, avoiding other cars is fairly straightforward, as they maintain strict lane discipline, but after that they start to weave in a pretty suicidal manner (and at night too). This really is a round-the-world trip, with different stages running through snowfields, the desert and along a causeway in the middle of a lake!

A simple enough concept for a game, but well executed with fine graphics. The only disappointment is the lack of any bends. The contest to produce that on the BBC, however, is another race altogether.

Simon Williams

A SCRAMBLE FOR EGGS

'Chuckie Egg', A&F, Unit 8, Canalside Industrial Estate, Woodbine Street East, Rochdale, Lancs OL16 5LB, BBC and Electron, £7.90

I COULD almost say this program needs no introduction, since it has featured at various positions in *Acorn User's* Top 20 for the past few months. And I'm not surprised.

Chuckie Egg is a 'platform' game in the best tradition; you steer a rather portly farmer along ledges, up and down ladders and on and off lifts to collect eggs and remove piles of grain from the path of the marauding geese (actually more like emus) that pursue

you. You collect a time bonus and points for every egg and pile of grain picked up. A large yellow duck is held quacking in a gilded cage at the top left-hand corner of the screen, and comes into its own at higher levels.

The graphics are good, though not spectacular. Each character is only single-colour, although quite chunky, and the geese are well animated as they peck at the grain.

Control is from the keyboard only, but the keys are redefinable, and there's a high score table to add your name to in all but the shortest of games. The main attraction of the program is that movement and control of your playing figure is very smooth and reassuring. You lose lives not because it's hard to get your figure to jump properly or line him up with ladders accurately, but because you mistime your moves and the psychopathic birds get you. This builds up just the right amount of annoyance to make you want to play again.

You have five lives, so a good long game isn't difficult to achieve.

Although not one of the most visually exciting games around, *Chuckie Egg* is certainly one I'm glad to have in my clutch.

Simon Williams

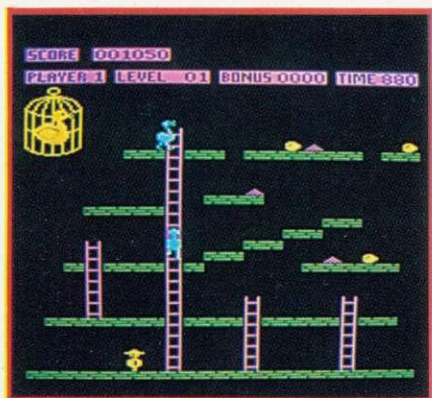

QUASIMODO'S

QUEST

'Hunchback', Superior Software, BBC B, £7.95

THE surge in home micro sales is due in part to the implementation of arcade games on the micro. One such game is *Hunchback*, which is as good a copy as you could expect. Superior Software sells the game under licence from Ocean, who originally wrote the game on the Commodore, and the Beeb version is near perfect.

The object of the game is for the hunchback Quasimodo to rescue Esmerelda from a castle tower. To reach her he has to get past a series of obstructions, so we find the Hunchback jumping across the ramparts or leaping Tarzan-style onto a swinging rope to reach the other side.

To make life more difficult as the game progresses, guards with spears appear, and boulders and arrows threaten our hero from both sides. The



game has 12 different screens, though the setting is one of two basic types. The object within each is for Quasimodo to cross the screen from left to right to pull the bell rope on the right-hand side. The screens vary in their difficulty and the user can choose which screen to start from, and three different levels of play are available.

The sound effects are adequate but an option to turn them off is sadly missing. Unusually, and pleasantly, only three keys are used, and these are conveniently laid out for ease of use. The game can be played on keyboard or joystick and includes a high score table.

The only fault with the software was the sideways scrolling across to the next screen which fails dismally. The movement is very jerky.

That said, I thoroughly enjoyed *Hunchback* and I'm pleased that my local pub is no longer reaping the benefits of my addiction.

Dee Vince

A World Of Information

Available to you with Nightingale, the new multi-function modem from Pace.

Nightingale is by far the most versatile modem available, at the price, for either home or business use. It offers Prestel/Viewdata baud rates (1200/75 & 75/1200) alongside 300/300 baud full duplex for communication between the BBC and other computers, including bulletin boards.

Nightingale will operate at both European and Bell frequencies for compatibility with CCITT and American systems.

The state-of-the-art modem chip technology employed in Nightingale requires minimal support circuitry resulting in low power consumption, low cost, high quality and extreme reliability.

Nightingale being 'hard wired' is not subject to the noise interference errors common to outdated acoustically coupled devices. In addition Nightingale features a simple self test facility for easy installation.

Nightingale utilises a fully buffered RS 423/232 serial interface and is supplied complete with a lead suitable for connection to the BBC micro, other leads are available on request.

However, in order to use such a versatile modem to its fullest potential, you will require equally sophisticated software. This is where Pace can offer you a total solution — Commstar, unquestionably the most comprehensive communications software available for the BBC.

Supplied on Eprom, Commstar is instantly accessible, simple to use and extremely flexible. Just look at the possibilities: access Prestel, Micronet, Viewfax, Homelink and Telecom Gold, rummage through bulletin boards and chat to literally thousands of other computer users, but there's more. Commstar can be used to emulate specific terminal types such as VT 100 by means of a configuration disc, thus providing the opportunity to use the BBC as an inexpensive workstation for a main frame or mini-computer.

The complete Nightingale/Commstar package for the BBC micro including the modem, cabling and the Commstar Eprom and manual is just £139 plus V.A.T. Nightingale is available separately for the BBC and other computers at £119 plus V.A.T. and Commstar is £29.57 plus V.A.T. Further details are available, please telephone or write for comprehensive fact sheets.



PACE

PACE SOFTWARE LTD.
92 NEW CROSS STREET,
BRADFORD BD5 8BS.
Tel. (0274) 729306 Telex 51564

This modem incorporates the very latest in communication technology and is therefore not yet B.A.B.T. approved.





HIGH RESOLUTION THAT COMES HIGHLY RECOMMENDED.

"There is no doubt that the JVC range of ECM colour monitors is excellent value for money . . . there is no loss in quality of picture after long periods . . . and remember, as more and more resolution is available with new micros, the need for a better display will be that much greater."

High recommendation indeed from Personal Computer News. Meanwhile Acorn User said:

"It seems that all 'normal' and 'medium' resolution monitors, including the Sanyo, are simply inadequate to deal with the Beeb's graphics and text output . . . The JVC was excellent, giving clear, legible results . . . Was the JVC better than the Microvitec?* Would I buy one? Yes to both questions."

Our RGB high resolution colour monitor (580 × 470 pixels) sells for £229.95 (excluding VAT) – that's a saving of over £100 compared with other leading monitors of similar specifications.

The unit has a 14" screen and is suitable for the BBC Micro, Electron, Sinclair QL, Lynx, Oric, Apple, IBM and most other leading micros.

MODEL REFERENCE	1302-2 High Resolution
RESOLUTION	580×470 Pixels
C.R.T.	14"
SUPPLY	220/240v: 50/60Hz.
E.H.T.	Minimum 19.5kv Maximum 22.5kv
VIDEO BAND WIDTH	10MHz
DISPLAY	80 characters by 25 lines
SLOT PITCH	0.41mm
INPUT: VIDEO	R.G.B. Analogue/TTL Input
SYNC	Separate Sync on R.G.B. Positive or Negative
EXTERNAL CONTROLS	On/off switch and brightness control

And naturally there's a year's full guarantee. If you order your monitor by post, you'll receive it within ten days by courier service.

Simply post the coupon below to: Opus Supplies Ltd., 158 Camberwell Road, London SE5 0EE. Or telephone 01-701 8668 quoting your credit card number. Or, of course, you can buy at our showroom between 9.00–6.00pm, Monday–Friday 9.00–1.30pm, Saturday.

*Microvitec Cub 14" monitor.

To: Opus Supplies Ltd., 158 Camberwell Road, London SE5 0EE.
Please send me:

_____ High Resolution Colour Monitor(s) at
£229.95 each (ex. VAT).

_____ Medium Resolution Colour Monitor(s) at
£179.95 each (ex. VAT).

_____ Connection lead(s) at £6.00 each.

I understand carriage per monitor will cost an extra £7.00. (N.B.A High Resolution Monitor including VAT, lead, and carriage costs £279.39. A Medium Resolution Monitor including VAT, lead and carriage costs £221.89).

I enclose a cheque for £_____ Or please debit my credit card account with the amount of £_____. My Access/Barclaycard (please tick) no. is _____

Please state the make of your computer _____

Name _____ AC26

Address _____

Telephone _____

Opus.
Opus Supplies Ltd.

The name of the
Game...

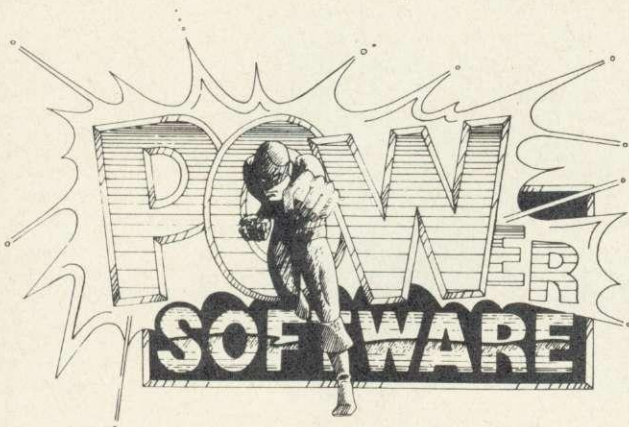

..IS COMING!

BASIC COMPILER

Turns your basic programs into really fast machine code. The compiler is very easy to use, and comes complete with full instructions.

For the BBC model B, or Model A with 32k.

Cassette **£17.95**

Disk **£19.95**

(40 TRACK)

Cheque/P.O. or SAE for details to

ACK Data

21 Salcombe Drive, Redhill,
Nottingham, NG5 8JF
Tel. (0602) 262498 (outside office hours.)

VICTOR MORRIS Glasgow

Authorised

acorn  dealer

B.B.C. B & acorn
electron

Disk Drives, Printers, Joysticks,
Acornsoft, Data Recorders, Monitors,
Adds ons by Pace, Torch etc.

spectrum Group Dealer

Access, Visa, Amex, Diners

340 Argyle Street

Between Central Station and Anderston Bus Station

Glasgow G2

Tel: 041-221 8958

SCOTLAND

	£ inc VAT
ACORN ELECTRON	£199.00
BBC MODEL B	£399.00
BBC MODEL B + DISK INTERFACE	£469.00
Z80 2nd PROCESSOR	£299.00
CUMANA DISK DRIVES FROM	£160.00
EPSON FX80 PRINTER	£420.00
EPSON RX80 F/T PRINTER	£295.00

ALSO WIDE RANGE OF
SOFTWARE AND ADD-ONS FOR
BBC AND ACORN ELECTRON.

All prices Include VAT.
CARRIAGE £8.00 per unit.

WEST COAST
PERSONAL COMPUTERS
47 Kyle Street, Ayr KA7 1RS
Telephone (0292) 285082

UPHILL STRUGGLE WITH TURBO

Turbo Compiler, Salamander Software, 17 Norfolk Road, Brighton, Sussex BN1 3AA, BBC, £9.95

THE prospect of producing a machine code program without having to write directly in assembler has always been attractive. One way to achieve this is to work in a compiling language such as Fortran or Pascal, but, leaving aside the necessity to learn a language other than Basic, there are as yet no full implementations of these languages for the BBC micro. The alternative is to compile the Basic code itself, and this, to an extent, is what the Turbo compiler tries to do.

The compiler resides in only 2k of the micro's RAM, so it is possible to have source and object code co-resident in the machine. This means that code doesn't have to be compiled from tape or disc. Once compiled, the code may be used independently of Turbo, either as a subroutine in a Basic program, or as free-standing machine code.

Turbo will compile only a limited subset of BBC Basic and this is perhaps its biggest problem. Keywords handled directly by the compiler are AND, CALL, CLG, CLS, END, EOR, FOR, GET, GOTO, GOSUB, IF, INKEY, LET, MID\$, MODE, NEXT, OR, PRINT, REM, RETURN, SOUND, THEN and TO. In addition, the operators ?, ! and \$ are supported.

Although the well-produced user guide lists some 65 keywords that may be compiled by Turbo, most of these are only achieved by 'fiddling' the syntax of others. For example, the COLOUR statement must first be translated into its equivalent VDU statement; COLOUR 3 would become VDU&11,&03.

Turbo handles only integer numbers and these must be in hex. Variables are restricted to the resident integers A% to Z% and these may only be assigned values in the range 0 to 255. Line numbers must also lie within this range and multi-statement lines are not permitted.

The publicity suggests that Turbo is an ideal intermediate stage between interpreted Basic and machine code, and it requires a fairly intimate knowledge of the MOS to be able to 'prepare' a program for compilation. Comparing the short program (listing 1) in its original and prepared forms gives some idea of the effort required to use it.

Whether you feel the speed increase (in this case about 25 per cent) is worth the extra effort is up to you. I would rather wait for a more comprehensive compiler that made the machine do a larger proportion of the work.

Simon Williams

MULTI-AID PUTS

TOGETHER THREE

UTILITY PROGRAMS

Multi-Aid by Dynabyte Software, £7.95

MULTI-AID consists of three utility programs, chained from an initial index program. The utilities are 'Character', 'Soundlab' and 'Graph7', each of which will be dealt with individually. The package comes with a small but comprehensive and simple booklet, and two function key strips.

'Character' is a useful utility for creat-

ing multi-coloured, simple or multiple characters, and can be used in all BBC graphics modes except mode 7. You first select the foreground and background colours from a menu of eight colours. Modes 1, 2 and 5 allow three foreground colours and the other two-colour modes allow only one. You then choose the size of the character you wish to create in multiples of the standard eight by eight pixel block. This will of course depend on the mode selected, as explained in the booklet; for example, in mode 2 you can create characters of up to two by three blocks. Having selected this you then define the ASCII code for your first character (between 128 and 255) and you are then ready to begin. To create a large number of multiple characters you will need to use non-standard ASCII codes and will require to explode the character set memory before starting. The use of *FX20 to do so is clearly explained in the booklet.

The next step is to select the option to define new characters or edit existing ones. In either case, each character is displayed normal size, and eight times normal for working on. All you now need to do is move around the display area using the cursor keys and set the pixels as required using the function keys for the desired colour. Another useful function controlled by these keys is the ability to copy a character, simple or multiple, to the next equivalent ASCII codes/memory area, effectively duplicating it. You can then carry on editing to make minor alterations for, say, animation, and avoid recreating the whole character. Similarly, you can list the resulting VDU23 statements, each of which also illustrates the character, and *SPOOL them to use in programs.

The booklet also explains how to recombine the VDU commands into the whole characters within any program. One criticism is that you are not able to use flashing colours. Another is that if you totally 'fill' the memory, you get a 'Too few characters left' message, from which you have to escape and re-run the program. However, you don't lose any of the work you've done as long as the same parameters are used.

'Soundlab' is a comprehensive utility for exploring sound and envelope commands by creating or editing your own commands or using the examples provided. It allows up to seven envelope and nine sound commands (including channel 0). The facilities for editing (including any one of the seven sound parameters individually), playing sounds singly or in sequence, killing a sound, altering any parameter whilst a sound is actually playing and so on, make it a very flexible utility. As with the 'Character' routine, all the created

BEFORE	AFTER
10 MODE 2	10MODE2
20 FOR N%=1 TO 255	20FORN%=&01TO&FF
30 GCOL0,N%	30VDU&12,&00,N%
40 MOVE N%,1023	40VDU&19,&04,N%,&00,&FF,&03
50 DRAW N%,0	50VDU&19,&05,N%,&00,&00,&00
60 NEXT	60NEXT
70 COLOUR130	70VDU&11,&82
80 VDU28,4,31,19,0,12	80VDU&1C,&04,&1F,&13,&00,&0C
90 END	90END

Listing 1. A short Basic program before and after compiling on the Turbo

star ATTRACTIONS

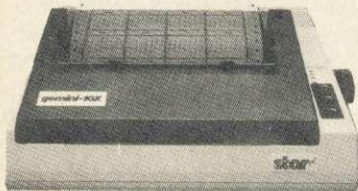

GEMINI-10X

£189.95

+ VAT = £218.44

120 cps ● Bi-Directional
Logic Seeking ● Friction
Tractor and Roll Holder
Standard ●

Downloadable Characters

● Ultra High Resolution
● 80 cols ● IBM PC
version now available.



12 MHZ Video Bandwidth
RGB and Composite Video

£169.95 + VAT
= £195.44



14 INCH COLOUR MONITOR

LOOK! NEW LOWER PRICES ON EPSON STAR & BROTHER

DAISYWHEEL PRINTERS

BROTHER HR 15	£349.95 + VAT = £402.44
JUKI 6100	£325 + VAT = £373.75
DAISYSTEP 2000	£225 + VAT = £258.75
STAR POWERTYPE	£328.95 + VAT = £378.29
EPSON DX 100	£369.95 + VAT = £425.44

DOT MATRIX PRINTERS

EPSON RX 80	£198.95 + VAT = £228.79
EPSON RX 80 F/T	£228.95 + VAT = £263.29
EPSON RX 100	£384.95 + VAT = £442.69
EPSON FX 80	£319.95 + VAT = £367.94
EPSON FX 100	£498.95 + VAT = £573.79
STAR GEMINI-10X	£189.95 + VAT = £218.44
STAR DELTA 10	£319.95 + VAT = £367.94
STAR RADIX 10	£498.95 + VAT = £573.79

THERMAL MATRIX PRINTERS

STAR STX 80	£129.95 + VAT = £149.44
BROTHER HR5	£129.95 + VAT = £149.44
BROTHER EP 44	£216.95 + VAT = £249.49

Cables - Paper - Ribbons - Sheet Feeders
Tractor Feeds - Interfaces - Call for Best Prices



**CREDIT CARD
HOT LINE
01-482 1711**



PLEASE ADD £10 + VAT FOR DELIVERY
POST YOUR CHEQUES/P.O.'s TO:

DATASTAR SYSTEMS UK
UNICOM HOUSE, 182 ROYAL COLLEGE STREET
LONDON NW1 9NN

Telex 295931 UNICOM G
TAX-FREE EXPORT & DEALER
ENQUIRIES WELCOME

SOFTWARE BONANZA

**50, YES, 50 HIGH QUALITY GAMES
AT SUPER LOW PRICES.**

BONANZA INCLUDES:

- Haunted Mansion:** A full colour 3D hi resolution graphics adventure game with over 400 rooms.
- 30 Space Ranger:** A full colour 3D simulation where you are a space pilot in the midst of intergalactic warfare.
- Arcade Games:** Such as Chopper Attack, Meteors, Dr. Who, Zaxxon, Spider, Breakout, Tank Battle, Sub Killer, Tron, Sniper, Speed Trail, Knight Rider and many many more too numerous to mention.
- Mind Games:** Such as ESP, Master Mind, 3D Noughts & Crosses, Sliding Letters and much more.
- Adventures:** Such as Dictator which puts you in the job of ruling a small republic.

All 50 fun packed games supplied all on one tape for the BBC model B at only £7.95 the lot.

(All tapes supplied with FREE instructions to transfer to disc)

20 EDUCATIONAL PROGRAMS: In a whole host of subjects including maths, physics, chemistry, geography, history, biology and others. Many programs make full use of hi-resolution graphics for added interest. All the educational software you will ever need for your BBC (B) at only:

£7.95 on tape
£9.95 on disc (40 or 80 track)

Business Pack:

Contains all the business software you could possibly want, to run a small business. The pack includes: spreadsheet, word-processor, payroll, VAT, accounts and a multi purpose database.

Business pack only:

£17.95 on tape
£19.95 on disc (state 40 or 80 track)

All software suitable for the BBC model B.

SOFTWARE WANTED for any micro High Royalties, or outright cash payment made.

SEND SAMPLES NOW!

DEALER INQUIRIES WELCOME

Send cheques to:

RANJAN, Dept. AU, 3 Wensley Close, Harpenden, Herts AL5 1R2.
(ALL GOODS DESPATCHED IN 3 to 4 DAYS)

SOFTWARE DEVELOPMENT/MSc in SOCIAL POLICY

We have recently introduced a micro-computer option into our MSc Research Programme, and are looking for good honours graduates, working in the public services, who wish to develop computer programs for professional purposes. The programme includes both software development and an evaluation of its effects in practice, leading to the submission of a program and dissertation for an MSc degree. We have both full-time (one year) and part-time (2 years) options. If you work in the social services, probation, education, health service or any other part of the public sector, and wish to develop expert systems, data bases, computer aided learning packages, etc, please contact:

Sue Isaac, Course Administrator, Department of Social Policy, School of Policy Studies, Cranfield Institute of Technology, Cranfield, Bedford MK43 0AL. Tel (0234) 750111, ext 3198.

PROGRAMMERS

Have you wondered why the top programmers stick with Kansas year after year, even way back from the Tandy days?

It is because they get a good deal, knowing that in no way will they be 'ripped off'.

But most of all they know that as we were the very first software publishers in the business, we will still be around long after today's crop of cowboys are long gone.

Our commiserations if you have supplied a program to one of the dozens of software companies who have now gone out of business, stuck with no royalties and no chance of interesting anyone else with a 'second hand' program.

If you have an exceptional new program, consider allowing Kansas to market it for you, getting a genuine 25% royalty, but most of all, peace of mind...

KANSAS CITY SYSTEMS

Unit 3, Sutton Springs Wood, Chesterfield. 0246 850357



commands can be listed and incorporated in your own program.

'Graph7' is yet another mode 7 screen generator for creating text, graphic or combined teletext screens. It makes use of the function keys on their own and in conjunction with the control and shift keys. Once you get the hang of it, it's quite easy and efficient. Special functions allow you to save up to 24 screens in memory at one time, and to switch between them. You can also *LOAD previous screens to look at or edit, and *SAVE or *SPOOL any screen to include in your own programs.

The package requires the 1.2 OS, but will work with either Basic. I would class it as one of the better utilities available: it is comprehensive and good value for money. If you do not already have any of these facilities, this is one I would definitely recommend.

Ian Rowlings

HELPING HAND IN

CALCULATIONS

'Titrations' by Shaw, Melia and Ellis, System Software, Arnold Wheaton, BBC, £14 plus VAT (tape and disc versions)

THIS very thorough and professional program provides 'a means for students to self-check the results of calculations associated with some acid base and acid carbonate reactions'. It is designed so that the student who has difficulty in accurately rendering the calculations may be guided through the process in a structured way.

The student using *Titrations* needs to be familiar with molarity and the way in which it relates to concentration. It is recommended that the students have a calculator handy - I certainly needed one. They are presented with the choice of dealing with figures supplied by themselves from their own experimental data or of using computer-generated problems as revision and remedial material.

Two levels of difficulty are available and, after choosing, the pupil will be asked to calculate either a molarity or a volume. When errors occur the machine branches into a HELP routine appropriate to the point in the equation that caused the difficulty. Continual failure to understand the help given results in the machine performing the calculation itself step-by-step, with the parts of the equation being operated highlighted. The program is patient, perceptive and persistent.

Although it is not very striking visually - it's all printed in cyan text on a black background - this perhaps underlines the serious intent of the program. It is designed to be used as a scientific tool and has no fancy frills. However, a print-out facility might have been useful so that the results, especially of pupils' own calculations and experiments, could have been taken away as hard copy.

Titrations is a robust and efficient program that uses the simple techniques of repetitive reinforcement to enable students to attain high standards of accuracy in their equations.

Nick Evans

SURREAL

PHRASEBOOK

'The Storyline', Daco Software, 59 Mackenzie Road, Moseley, Birmingham B11 4EP (021-449 2253), BBC, £7.95

THE STORYLINE is a text-handling program that enables a budding Shakespeare to produce some most peculiar, although strangely fascinating, stories. I am sure that the original intention of the program was for the child using it to create sense in a normally acceptable fashion, but the side-effect is that the text produced by the program has a strange surrealist quality about it:

'I rang the bell. Then, a thin clown saved me and then the thing dodged it. In the end, it walked out of my head.'

The seven-year-old T S Eliot who

One day the baby giant ate the
pram. My mum hid under it. But, a
tall boy pushed him and then I
ran from the thing. Long after, it
walked out of a nest. Stiffly,
one more pretty frog was lost in
the pram.

You

Press X to keep the word(s)
Press any other key to change

created this masterpiece was fascinated by the weird atmosphere and unreal quality that this sort of 'random text' produced. Of course, it need not necessarily be totally random since the child who is using the program governs what goes into it at each stage.

There are two levels of operation, with vocabulary of varying degrees of difficulty. The words to be chosen are flashed one by one on the screen and you may choose to keep the word by pressing 'X' or try another by pressing any other key.

On pressing 'X' the word is transferred to the top of the screen in the next position available in the sentence under construction. One thing that my test-pilot found to be a problem was that if, in his enthusiasm, he made a wrong choice there was no way of deleting the chosen word - in fact, editing facilities are nil, which severely limits its use. You may send the whole story to the printer at any point or view it on the screen. After printing, the same story may be continued or another started.

The program centres around the use of data, accessed line by line, in a syntactically governed order. So, for example, the opening may be 'Long ago' or 'One day' or 'Once' or any others out of a selection of ten choices within each phrase's data line. Then comes the definite article, followed by an adjective and then the subject noun, a verb and finally a direct object. This structure varies as the program progresses.

The Storyline is a most interesting program with great possibilities at the junior school and remedial levels.

Nick Evans

CHARACTER MATCH

'Alphabet' by D J Millidge, Opalsoft, £9.95

THIS program, which comes in two parts on cassette, claims to 'stimulate the interest of children of all ages, especially beneficial to those learning their ABC'. It does this by the use of the extensive graphics facilities of the BBC, which are used with some imagination. The presentation is pleasant and does not distract from the task in hand. But here's a problem - what is the task in hand?

A child of, say, four or five years old who has just started learning to read is expected to look at the picture displayed on the screen and associate that picture with one of four lower-case letters that are presented in a row underneath it. The question is whether it is either educationally valid to make associations between letter shapes and printed words rather than between

You'd have to spend over £3000 to beat our £199 Second Processor.

The BBC Micro is already one of the fastest and most powerful micros around.

But with the addition of the 6502 Second Processor, it becomes the fastest micro in its price range.

(To be fair to the opposition, their £3000+ package includes a disc drive. But a similar BBC Micro set-up with the 6502 Second Processor will cost you less than a third!)

The 6502 greatly expands the Micro's usable memory. Its 64K of RAM combines with the BBC Micro's 32K, for a total of 96K.

It is supplied with its own special version of BBC BASIC, called Hi-BASIC, which allows the maximum amount of this memory to be used for BASIC programs and variables. Other languages allow some or all of this memory to be used for programs, and many will automatically adjust themselves to make maximum use of available space.

What's more, the 6502 uses the same microprocessor as the BBC Micro, but at a much higher speed. Which means programs can run up to 50% faster.

The 6502's extra power enables it to run more powerful software, such as that provided with the Acorn Bitstick, which turns the BBC Micro into a versatile computer graphics station. In fact, it has a variety of features usually found only on much larger systems.

It can also exploit the full potential of local area networking through the Econet system, with Level 2-File Serving.

So to get the most from your BBC Micro, get the 6502 Second Processor.

The 6502 Second Processor is available from your BBC stockist. For the address of

your nearest supplier, ring 01-200 0200.

If you wish to order by credit card, phone 0993 79300 during office hours.



6502 Development Programs (available separately)

MASM: A 6502 macro-assembler. A full range of macro facilities are provided, including looping recursive calls and conditional assembly.

XREF: A cross-referencer to be used in conjunction with MASM.

ViewEdit: A full screen editor based on the VIEW word processor.

TRACE: A 6502 trace package for de-bugging all types of program.

PRINT: A program to produce formatted assembly listings without using MASM.

The package is provided with a 250-page manual describing all the facilities provided by the system.

Technical Specifications

The Second Processor operates at a clock rate of 3MHz. A version 1.2 MOS will need to be fitted into the BBC Micro before operating the 6502.

Integral power supply

Measurements: 205mm x 345mm

Weight: 2.1 kg

Colour: BBC Computer cream

Construction: Moulded top and bottom to match BBC Computer profile. ABS injection moulded plastic.

Power in: 240v, 50Hz, 3w.

The BBC Microcomputer System.

Designed, produced and distributed by Acorn Computers Limited.

letter sounds and aurally received words when the child is at the 'ABC' stage, or whether it is indeed possible for the brain of a child so young to make that 'leap'.

Having chosen the letter the child then moves an arrow using the cursor control keys until it is positioned roughly under the letter and presses COPY (why not RETURN?) in order to confirm his choice. If the choice is wrong a large cross appears, the word itself is displayed under the picture and the correct letter highlighted. The wrongly answered picture is later returned to and the process continues till all pictures are covered.

Another problem, which arises with all programs of this type, is that the characters displayed in the book are not compatible with those on the screen. Nor are the pictures in the book compatible with those in the program – 't' for tree in the book and for tardis (!) in the program.

These inconsistencies appeared in the first part of the program and were then corrected in the second part when the letters were done again.

All in all it was a peculiar program; a shame as the graphics and sound were fun.

Nick Evans

BATTLE LINES

'Battletank', Superior Software, BBC B (32k), £7.95

CONSIDERING the amount of memory available on the BBC when using hi-res graphics, it is something of a wonder that anyone should try to mimic a game as graphically complex as *Battle Zone*. The arcade original employs vector-scanning techniques in a similar way to an oscilloscope. To simulate this on the Beeb requires some pretty complex line-drawing algorithms, and unfortunately this shows in *Battletank*.

For those who don't know the scenario, you move a rather futuristic tank around an isolated plateau, taking potshots at any enemy tanks you can get in your sights. *Battletank* doesn't sport the landers and flying saucers of the original, but does add a colour element. Control is via keyboard only – the game wouldn't lend itself to joysticks anyway. The main problem is that everything moves rather slowly and jerkily. It is very difficult to get the opposing tank into your sights, not because of its agility but due to the resolution of screen movement. To achieve reasonable tank speed, Super-

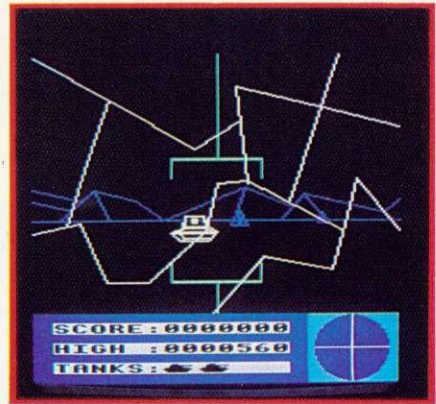

ior has had to make each movement step quite large. The same is true for the scrolling of the landscape.

The program appears to have been written in mode 5, a decision I would question in view of the greater resolution available in mode 4. Since the original game is in only one colour, it would perhaps have been a better bet to stick to this scheme and draw more accurate tanks and pyramids.

I have a lot of admiration for the programming skill involved in writing *Battletank*, but still feel the game loses its interest quite quickly because of the lack of variety.

Simon Williams

UNICORN

◀ page 141

necessary, according to Torch, to attain compatibility with other products. A sound reason, but it slows down the operation of some Unix facilities to an almost unacceptable extent.

In other words, the 256k memory and 8MHz 68000 processor are just about capable of handling Unix successfully; put the bottleneck of the 6502 between them and the vital hard disc, and some processes become seriously delayed.

This problem might be overlooked were it not for the way it interacts with other, apparently minor, deficiencies. We have already mentioned that pressing BREAK loses the whole Unix session, and this is more annoying when it takes four minutes (no less!) to log on. When using the screen editor 'vi', the regular transfer of data to disc, unnoticeable on most systems, takes about three seconds on the Unicorn. This means that suddenly the letters you are typing fail to appear on the screen, and a three second delay occurs before they do, all in a rush. This happens once a line, not once a page. Since the whole idea of a screen editor is that the things you type appear on the screen immediately as well as going to memory, this is somewhat annoying.

Given that Torch is unlikely to

change the architecture to the extent of eliminating the hard disc bottleneck, the company could perhaps recognise the data transfers to make them less intrusive in the context of interactive processes such as text input and editing. This is a relatively minor change, and the kind of thing Torch should have put right much earlier. For non-interactive processes it is not so annoying, though it still slows things down.

Otherwise the Unicorn provides an impressive, low-cost introduction to Unix. All that you might expect is there (even YACC, the Unix compiler-compiler) bar the tutorial and manual facilities usually found on big systems. These would have used up too much disc space, and Torch wisely decided to concentrate on good-quality printed manuals rather than wasting disc space putting the information in the machine.

The slowness of the hard disc transfers belied the speed of execution of the 68000: timing tests showed that it was doing okay provided it didn't have to wait for the 6502 to transfer a big lump of data for it. Usually that was the downfall of the execution times.

Overall the system was impressive but slow. Torch has one or two things it should definitely sort out (principally the BREAK key and the regular hang-ups in 'vi' for disc transfers), but the problem of the slow hard disc transfers

is probably built-in. It will be interesting to see what happens in a 512k or 1Mb machine.

A good buy? Possibly. There are systems costing less than twice the price that I think are probably twice as good. But there is no route to Unix quite as cheap as the Unicorn. When the Acorn 16032 second processor comes out, ostensibly providing Xenix (from floppy discs?) at around the £1,000 mark, Unicorn will no longer be the cheapest. Even then, however, it seems likely that we will be getting roughly what we pay for in every case.

The likely market is difficult to pin down. The Unicorn is not really for business use, unless the business happens to be software or at least has somebody around who can make use of Unix. It cannot be used by more than one person simultaneously, but is out of reach of all but the richest hobbyist. The serious systems programmer or small software house is the most likely target, and the university or college microcomputer section. Yet for most of us it will probably seem too slow.

So you might be a foolish virgin to go for Unicorn. On the other hand, it is one way of becoming a wise virgin, in the sense of getting genuine interactive experience of Unix.

The trouble is, to achieve the wisdom of Solomon, you may need the patience of Job.

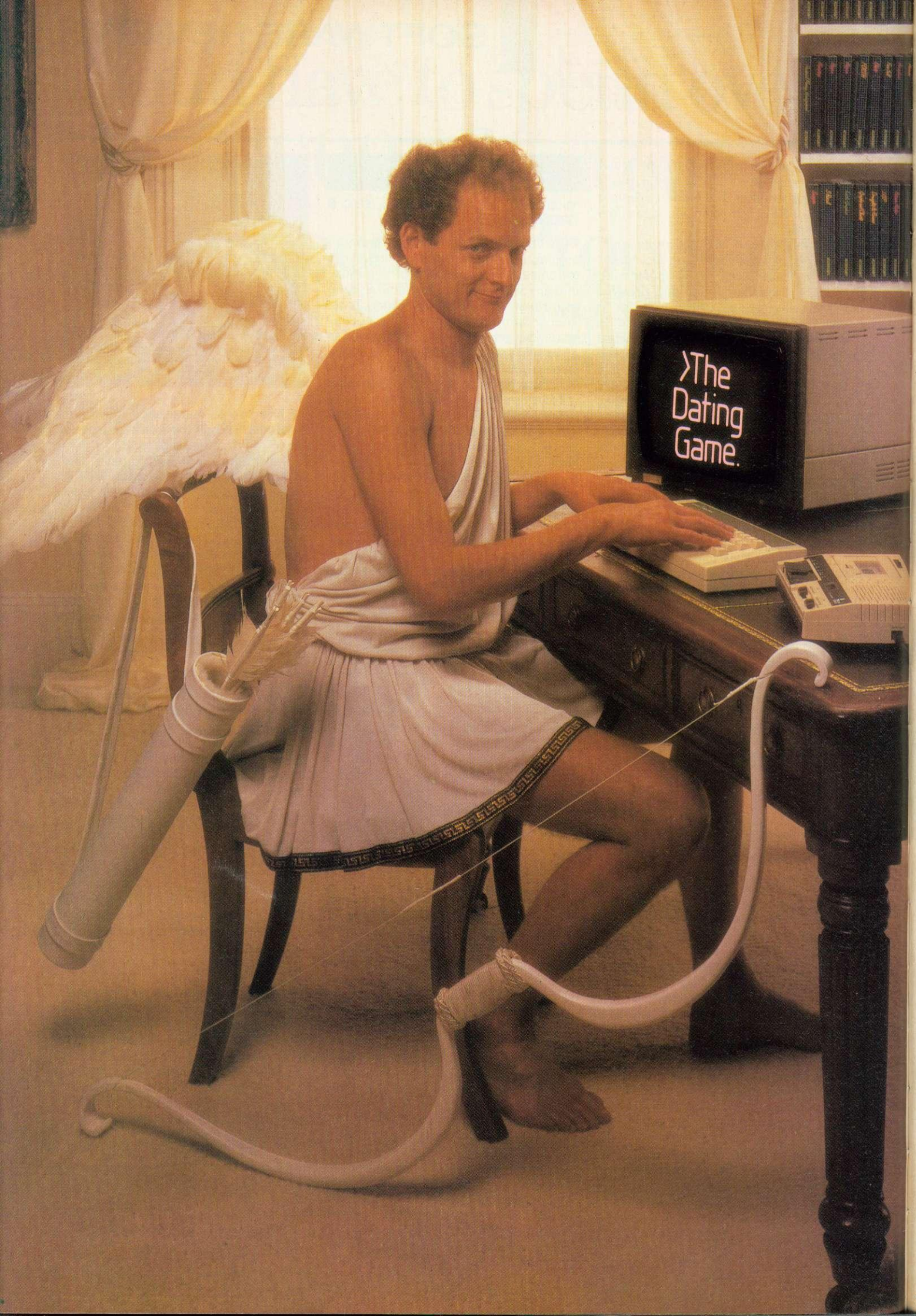

>The
Dating
Game.

The Electron has added even more strings to its bow.

The list of top quality software for the Acorn Electron is growing all the time.

As you can see, there's already an outstanding selection of exciting programs covering everything from monsters to music and murder to marriage guidance.

And ultimately, the Electron will enjoy a range of software as comprehensive as that of its illustrious big brother, the much-acclaimed BBC Micro.

You'll find all the programs featured here at your local Acorn stockist. (To find out where that is, simply call 01-200 0200.)

Alternatively, you can send off for the Electron catalogue and order through the post by writing to Acornsoft, c/o Vector Marketing, Denington Estate, Wellingborough, Northants NN8 2RL. Tel: 0933 79300.

GRAPHICS: Graphs & Charts, Creative Graphics, Picture Maker.

BUSINESS: Personal Money Management, Desk Diary.

EDUCATION: Tree of Knowledge, Peeko-Computer, Business Games.

LANGUAGES: LISP, FORTH, S-Pascal, Turtle Graphics.

GAMES: Starship Command, Monsters, Chess, Draughts and Reversi, Snapper, Meteors, Hopper, Sphinx Adventure, Arcadians, Free Fall.

QUIZZES: Theatre Quiz, Crime and Detection Quiz, Music Quiz, History Quiz, Science Fiction Quiz, '...I Do', The Dating Game.

CHILDREN'S EDUCATIONAL SOFTWARE: Happy Numbers, Timeman One, Timeman Two, Wordhang, Happy Letters, Map Rally.

ACORNSOFT

Electronequip

(Authorised BBC Dealer, and service centre)

*** SPECIAL OFFERS**
Mail order only

*EPSON

RX-80FT £225.25 + VAT

FX-80 £320.88 + VAT

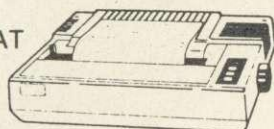

Printer price includes cable for BBC and screen dump rom is available for £11.50

SIDEWISE

SIDEWISE FITTED

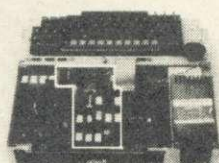
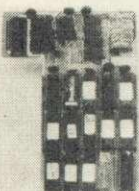

"SIDEWAYS" rom board for BBC Micro.
No soldering required £38.00 + VAT

**5 FREE ACORNSOFT
GAMES & CASSETTE
RECORDER WITH EVERY
BBC SOLD**
(WHILE STOCK LASTS)

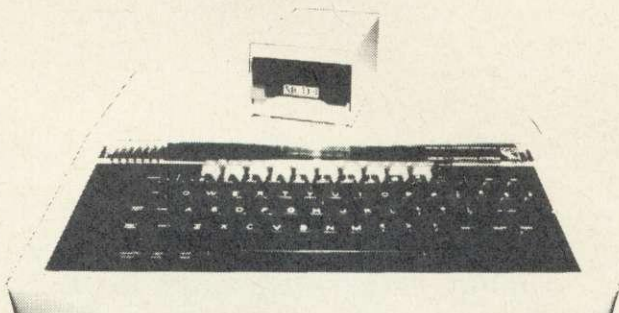

Electronequip is an authorised Acorn service centre and has been an Acorn dealer since the introduction of the Atom. Our demonstration facilities include 20 station Econet and Torchnet systems.

Ref.	BBC Micros	Ex VAT	Inc VAT
ANB01	BBC Model B Micro Computer	348.26	399.00
ANB02	BBC Model B with Econet Interface	389.14	446.00
ANB03	BBC Model B with Disc Interface	409.14	469.00
ANB04	BBC Model B with Disc & Econet Interface	450.01	516.00

VOLTMACE JOYSTICKS

***10% off list prices**



Discounted price

JSVOLT 14	Voltmace Delta 14B Joysticks	13.46
JSVOLTAD	Voltmace 14B/1 Adaptor Box	13.36
JSVOLT3B	Voltmace Delta 3B Twin Joysticks	18.09

Prices subject to variation without prior notification

TRADE ENQUIRIES WELCOME
Access & Barclaycard Accepted
Large Stocks - 24 Hour Despatch
Carriage 46p

3" Micro Disc £129.95
(inc. VAT)

**Disc Interface &
Drive**
£198.95 (inc. VAT)

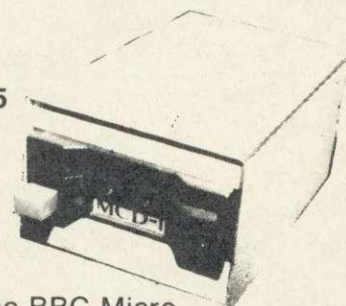

Micro Disc Drive for the BBC Micro

The Micro disc drive offers a method of low cost quick access to programs. The drive is essentially a small version of a 5¼" disc drive and offers similar features to the larger drive. The data is stored on a 3" disc, this is enclosed in a protective hard plastic cassette which features a write protect switch. The micro drive requires the standard Acorn disc interface, but a new disc filing system rom. Acorn DFS may be exchanged for the micro DFS for £12.00. The new micro disc filing system can read and write to Acorn DFS discs. Thus if a 5¼ inch and a micro floppy were connected on the same cable files could be transferred between them.
Capacity: 80.64 K bytes Transfer Rate: 125k bit/s.

BRANCHES

FAREHAM: 59 WEST STREET (0329) 230670
KINGS LYNN: 17 TENNYSON AVE. (0553) 3782
MAIL ORDER: 36-38 WEST STREET
FAREHAM, HANTS. (0329) 230670



Electronequip

36-38 West Street, Fareham, Hants (0329) 230670



BBC MICRO

- USER SUPPORT -

LOOK WHAT YOU
MISSED IN BEEBUG
VOLUME TWO

- 10 ISSUES OF BEEBUG MAGAZINE
MAILED FREE TO MEMBERS
- 30 EXCITING GAMES AND VISUAL PROGRAMS
- 43 SOFTWARE REVIEWS
- 33 HARDWARE REVIEWS
- 16 BOOK REVIEWS
- 150 HINTS AND TIPS
- 25 APPLICATION PROGRAMS
- SERIES OF ARTICLES FOR BEGINNERS
- MANY ADVANCED TECHNICAL ARTICLES
- NEWS AND PRODUCT INFORMATION
- PLUS SPECIAL OFFERS
- BIG DISCOUNTS ON A WIDE RANGE OF PRODUCTS
- EVENTS
- BRAIN TEASERS
- LOCAL CLUBS
- FULL MAGAZINE INDEX

A YEARS SUBSCRIPTION WOULD HAVE BOUGHT YOU ALL THIS

Figures based on the 10 issues of BEEBUG Volume 2.

BUT IT'S NOT TOO LATE TO JOIN FOR VOLUME THREE

BEEBUG PUBLICATIONS LTD. PO BOX 109, HIGH WYCOMBE, BUCKS

PLEASE ENROL ME FOR VOLUME 3
OF BEEBUG AT £9.90 (10 ISSUES)

NAME

ADDRESS

AMOUNT ENCLOSED

PLEASE MAKE CHEQUES PAYABLE TO
BEEBUG PUBLICATIONS LTD.
AND SEND TO:- DEPT 13, PO BOX 109
HIGH WYCOMBE, BUCKS.
(DISTRIBUTION AGENTS FOR BEEBUG)

**BEEBUG HAS BEEN
ESTABLISHED FOR TWO
YEARS AND NOW HAS
OVER 25,000 MEMBERS. IT
OFFERS TOTAL USER
SUPPORT TO ALL BBC
MICRO USERS.**

Simple, reliable, and still the most popular
word processor for the BBC Micro.

ROM
Manual
& Typing Tutor Course

Price **£46**
inc.

Wordwise
The word processor for the BBC micro

COMPUTER
CONCEPTS

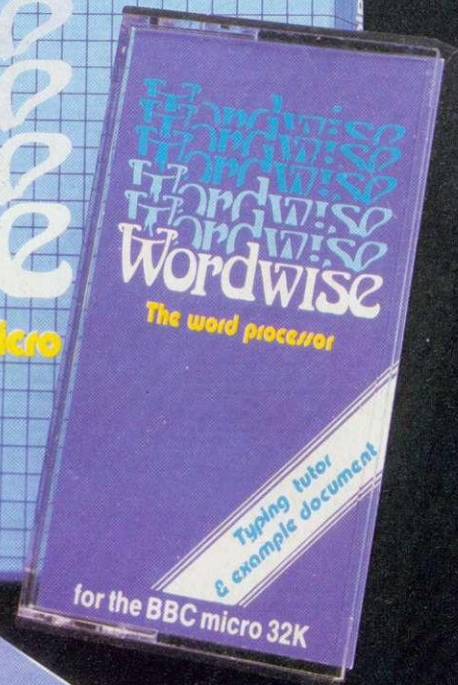

COMPUTER
CONCEPTS

Available from all good BBC Computer Dealers.
Available by Mail Order from Computer Concepts, Gaddesden Place, Hemel Hempstead,
Herts HP2 6EX.
Or by 'phoning with your credit card number on (0442) 63933.



LVL COMPUTERTOWN

Whether its your first computer or whether you're already an enthusiast, LVL COMPUTERTOWN offers you the quality of service you expect from experts. If you invest money, you go to a bank or a broker - a specialist who can guide and advise you on the best return for your capital. At LVL COMPUTERTOWN we're specialists too. We're there to help guide you through the micro maze, keep you up to date on innovations, help you get the best value for money, whether your computer is for you, your children or your business. Your computer can change your life - make sure you change it for the better: Come and talk to the experts and move into micros with LVL COMPUTERTOWN

PRINTERS

NEC PC-8023-N Dot-Matrix Printer.
Economical all purpose printing for your computer.



£228.85

- Centronics-computible parallel interface.
- Bidirectional logical seek operation for high speed printing (120cps).
- Output to printer can be on character-by-character or even dot-by-dot basis.
- Many character sizes; fan fold and single-single sheet paper.
- Automatic reversal of ribbon gives clear, crisp impressions for a long period of time.

COMPUTERS

BBC MICROCOMPUTER



Model B	£399
Model B with ECONET	£446
Model B with DOS	£469
Model B with DOS & ECONET	£516



£199.00

The new personal computer from Acorn Computers. An ideal machine for learning computing — and for having a lot of fun at the same time. But it's much more than just a toy. It's graphic facilities are the most sophisticated available in it's price range.

MONITORS

Fitted with the Euro-Standard connection. The SABA combines: input and output for video and audio, RGB inputs and this direct control of the colour tube (that is to say absolutely lossfree direct input of the picture signal) makes the SABA ideal for all video recorder standards, video text, video games and home computers. SABA is among the very few manufactures providing this advanced universal connection — giving you the best of both worlds — Colour monitor and Colour TV.



£246.85

SABA 14" Colour Monitor/Colour TV.

DATA RECORDERS



£ 39.95

A REFLECTION OF SUPERIORITY

The Bell & Howell/LVL Computer Compatible Data Recorder

- Automatic Level Control
- Automatic Tape Stop
- Tape Counter
- Remote Motor Control

DISK DRIVES

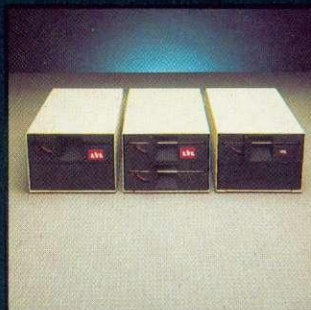

An example of superior technology, total reliability and outstanding performance, combine to produce the LVL Disk Drive Family.

Truly professional units designed to work with the BBC Microcomputer.

PRICES START FROM £179.57

JOYSTICKS

British Made and fully guaranteed, the LVL twin joysticks are professional units with which your aim should be nothing less than total control. They will operate any programmes that have a joystick option and are written in a way that is compatible with Acornsoft.



£21.95

- 12 months guarantee
- Fully compatible with the BBC model 'B' or 'A' fitted with an A/D interface and an analogue port.
- Nylon encased-steel shafted joysticks with ball and socket joint
- Fast spring return to centre
- Graphite wiper linear potentiometers

SOFTWARE

At your local COMPUTERTOWN Dealer you'll find hundreds of titles. for most popular home computers, offered at prices and skill levels to suit all your desires. To avoid disappointment please telephone your local stockist for a full availability and price list.



ALL PRICES
INCLUDE
VAT.

The items featured represent a very small selection from our vast product range, and at the time of going to press were all available from stock. However, not all dealers carry every advertised item, please telephone before making your journey.

For further details, and full product literature pack call or telephone your nearest LVL Computertown Dealer.

CHESHIRE

C. TECH SOFTWARE
184 Market St.
HYDE
Cheshire
061 386 8223

CUMBRIA

THE COMPUTER SHOP
56/58 Lowther St.
CARLISLE
Cumbria
0228 27710

ESSEX

A.C.L.
1 Northmall
GRAYS, ESSEX
0375 79834

BROADWAY MUSIC
AND VISION
Woodford Green
ESSEX
01 504 7800

GREATER MANCHESTER

LOMAX
8 Exchange St.
St. Annes Square.
MANCHESTER
061 832 6167
* Home & Business
Computers Ltd.
54, Yorkshire Street,
OLDHAM
061 633 1608

WORC'S

SPURTREE COMPUTING
LTD.
Council Buildings
Teme Street
TENBURY WELLS,
Worcestershire
0584 81153/811304

MERSEYSIDE

THORNGUARD
46, Pensby Rd.
HESWALL
The Wirral
Merseyside
051 342 7516

NOTTS'

S P ELECTRONICS
48, Linby Rd
HUCKNALL
Notts.
0602 640377
COMPUTERTOWN (UK) LTD.
230, Derby Rd.
STAPLEFORD
Notts.
0602 399484

OXFORD

ABSOLUTE SOUND
AND VIDEO (Oxford) Ltd.
19, Old High St. Headington
OXFORD
0865 65961

AVON

K & K COMPUTERS
32, Alfreds St.
WESTON
SUPER MARE
Avon
0934 419324

COLSTON COMPUTER
CENTRE LTD.
The Colston Centre,
11, Colston Ave.
BRISTOL
0272 276619

YORKSHIRE

HOME & BUSINESS COMPUTERS
59, Daisy Hill
DEWSBURY
Yorks
0924 455300

BUCKS'

HI-VU ELECTRONICS
38, Church St. Wolverton
MILTON KEYNES
Bedford
0908 312808

SUSSEX

C.J.E. MICROS
78, Brighton Rd.
WORTHING
West Sussex
0903 213900

W MIDLANDS

JBC MICRO SERVICES
200, Earlsdon Ave.
Nth. Earlsdon
COVENTRY
0203 73813

WILTSHIRE

WILTSHIRE MICRO CENTRE
Unit 6, Central Trading Estate.
Signal Way,
Old Town,
SWINDON
0793 612299

YOUR
LOCAL



DEALER

HEREFORD

KEMPSONS
26, St. Owen St.,
HEREFORD
0432 273480

KENT

KENT MICRO
57, Union St
MAIDSTONE
Kent
0622 52784

LEICESTER

PERCY LORD & SON
63, Blaby Rd
WIGSTON
Leicester
0533 785033

LONDON

CANNONBURY RADIO
185, Upper St
ISLINGTON NI
London
01 226 9392

PAUL ELECTRICAL
250/2 Grand Drive,
Raines Park,
LONDON SW20
01 542 6546

WOODS RADIO
257, Lavender Hill,
Battersea,
LONDON
01 228 1768

SALOP

MEDICOTT BROS.
53, Mardol
SHREWSBURY
SHROPSHIRE
0743 3060

NORTH'LAND

NEWTONS
Main St.
SEAHOUSES
0665 720307

STAFFS

J W BAGNALL
18, Salter St.,
STAFFORD
0785 3420

SURREY

* HASLEMERE COMPS
25, Junction Place,
HASLEMERE
Surrey
0428 53850

P & H ELECTRONICS
5, The Parade,
Reading Rd,
YATELEY
Surrey.
0252 877 222

ISLE OF WIGHT

EXCELL
4, Foreland Rd.
BEMBRIDGE
Isle of Wight
098 387 2578

LANCASHIRE

* P V MICROS
38A Water St.
ACCINGTON
Lancs
0254 36521

Home & Business
Computers (RCH) Ltd.
73, Yorkshire Street,
ROCHDALE
0706 344654

WALES

S.I.R.
91, Whitchurch Rd.
Cyncoed
CARDIFF
Wales
0222 621813

THE COMPUTER SHOP
41, The Hayes,
CARDIFF,
Wales,
0222 26666

SCOTLAND

COMMSCOT
30 Gordon St.
GLASGOW
041 2264878

SERIOUS DECISIONS NEED THE SUPPORT OF OUR 80 COLUMNS



Most serious users of micro computers require the facility to display in 80 columns, especially for word processing. Try this on most monitors and the result will be a frustratingly fuzzy image.

The Microvitec CUB 653 gives the user not only glowing colour, but also pin-sharp-images, thanks to a medium resolution screen 653 pixels wide by 585 high, plus a selective transmission

panel giving super-high contrast. These features make this model from the CUB range of monitors the perfect partner for the high resolutions generated by BBC B, SINCLAIR Q.L., I.B.M.,

ELECTRON, ORIC, APPLE II and Ii, and many others.

So if you wish to sharpen your image, whether in the office or at home, decide Microvitec:

Remember – the highest quality doesn't have to mean the highest cost.

Call at your local dealer or contact us direct and we'll send you full details with a pleasant surprise – our price list.

MICROVITEC
cub
COLOUR DISPLAYS

Microvitec PLC., Futures Way, Bolling Road, Bradford, West Yorkshire, BD4 7TU. England. Tel: (0274) 390011 Telex: 517717

Microvitec Monitors are available from your specialist local computer dealer, selected branches of W. H. Smith, John Lewis Partnership, Lasky's, John Menzies, Greens at Debenhams and other leading retailers.



SYSTEM SOFTWARE

•ROMs FOR THE BBC MICROCOMPUTER•

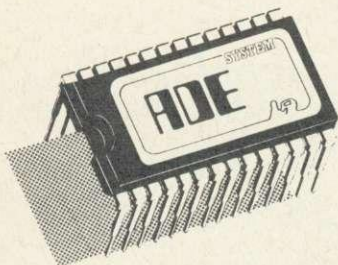

The complete program development package for assembly language programmers. ADE is the de facto industry standard for professional software writers using the BBC microcomputer. The 16k ROM contains a full 6502 MACRO assembler, a dynamic text editor, a front panel debugging monitor and disassembler. ADE comes complete with a 160 page comprehensive reference manual and a utility/macro library disc. ADE can also be used with tape based machines.

The ASSEMBLER features macros with library facilities; nestable conditional assembly; flexible listing options (with or without macro expansion); hex, decimal, binary and ASCII data formats; dummy section; full range of arithmetic and logical operators; symbol table sort and dump; file chaining and 29 powerful pseudo ops. Source and object files are kept on disc so there is no limit on program size or location.

The EDITOR is designed with the programmer in mind for writing both programs and documentation. The editor includes a very powerful command language (including macros) that enables much editing to be done on a semi-automatic basis. It features full screen editing and deferred edit modes; no limit to document size; edit with backup facilities and a versatile text formatter.

The DEBUGGER is instantly accessible for inspecting, modifying and disassembling machine code programs. Features include full 64 byte display in hex, ASCII and disassembled format; registers; stack; single step; breakpoints; memory search and much more.

Price £60 inc vat. Please specify 40 or 80T utility disc.

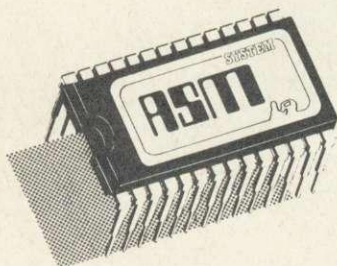

ASM provides all the superb features of the ADE macro assembler on its own ROM.

The program source file may be written using any editor (even Wordwise or View!). Complete with reference manual and utility/macro library disc. Use the assembler that professional software writers use.

Price £35 inc vat. Please specify 40 or 80T utility disc.



SEE US AT
The 2nd
Official
Acorn User
Exhibition
OLYMPIA
16-19 AUGUST
1984
STAND 26

SPY2 is a front panel debugging monitor, disassembler and disc utility ROM. SPY2 is instantly accessible to the programmer for inspecting, modifying, debugging and disassembling machine code programs. SPY2 also features a relocater and program trace facilities. SPY2 will access any ROM either in the sideways ROM sockets or on an extension board. ROM memory may be displayed, single-stepped through or disassembled.

SPY2 includes a set of powerful disc recovery commands for interrogating, editing and retrieving data stored on a floppy disc. SPY2 also includes a disc formatter as well as a non-destructive single track reformatter.

In all SPY2 has a comprehensive set of 23 utility commands. These are supported by an excellent Reference Manual.

The SPY2 front panel encompasses all the superb, easy-to-use facilities of the renowned SPY debugging monitor PLUS additional commands for toggling and finding breakpoints; relocating machine code programs; single stepping through subroutines in one go and facilities for accessing the front panel from programs in RAM or ROM with breakpoints, OSBYTE or CTR-F.

SPY2 features a versatile disassembler with hex dump, full and intelligent disassembly. This identifies data areas in the program; these being displayed as a hex/ASCII dump. Operating system calls are labelled creating very readable code. The powerful trace facilities enable program instructions and register contents to be traced to printer whilst the program is running. Indispensable for graphics programs as they can be stepped through whilst observing the effects on the screen.

SPY2 features a disc sector editor displaying the contents of a whole sector; disc search facilities for finding byte patterns or strings and free disc space. Files may be recovered by creating a directory entry with all the data concerning the deleted file. Directory entries can be easily amended using the *AMEND command. The *FORMAT command formats discs with any number of tracks. A verify command checks discs. The *REFORMAT command is extremely useful for recovering information from a bad track, reformatting it and restoring the data. Commands are included for loading files at \$1900 and automatically downloading (and running) them.

The most comprehensive of all debugging/disc utility ROMs.

Price £30 inc vat.

SYSTEM

Dept. A 12 Collegiate Crescent, Sheffield S10 2BA

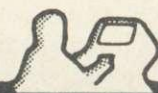

✓ This indicates clubs that have responded to our circular asking for confirmation of details and continued existence. Would those clubs who have not responded please do so, otherwise they will be deleted from our list.

- ✓ **The Secretary Wakefield BBC Micro User Group**
116 Pinderfields Road
Wakefield
West Yorkshire WF1 3PL
- Colin Price
Keighley Computer Club
Red Holt
Hainsworth Wood
Keighley
W. Yorks
Tel: Keighley 603133
- Jennifer Woeller
Sutton Library Computer Club
Sutton Central Library
St Nicholas Way
Sutton, Surrey
Tel: 01-661 5031
- Mr C. Rutter
Medway Atom Users Club
St John Fisher School
Ordnance Street
Chatham
Kent
- Mr J. Ashurst
Acorn Computer Users Group
Abraham Moss Centre
Crescent Road
Manchester 8
- ✓ **BBC Adventure Club**
18 Weardale House
Woodberry Down
London N4 1QN
- ✓ **John Wood Atom Users' Group of Canada**
812 Cabot Trail
Milton
Ontario L9T 3M8
Canada
- ✓ **Austin Vaughan Irish Amateur Computer Club**
35 Monastery Drive
Clondalkin
Dublin 22
Eire
Tel: (01) 593112 (evenings)
- ✓ **Miss J. Lines South East Essex BBC User Group (SEEBUG)**
97 Oakhurst Drive
Wickford
Essex SS12 0NW
Tel: 03744 63396
- ✓ **D. Donaldson, Secretary Bracknell Primary Schools Computer Users' Group**
Wildridings County Junior School
Netherton
Bracknell
Berks RG12 4DX
- Stuart Mallinson
Huddersfield BBC Micro User Group
34 Ryefields
Scholes
Huddersfield
West Yorks HD7 1XF
- J. Smith, Secretary
Brighton, Hove & District Computer Club
30 Leicester Villas
Hove
E. Sussex BN3 5SQ
- ✓ **Mr Ric Keyworth North London BBC Micro Users Group 'The Penthouse'**
4b Kilburn High Road
London NW6 5UL
Tel: 01-734 9235
(7am-3pm Mon-Fri)
- **West Midlands Computer Group**
12 Apsley Road
Oldbury
West Midlands B68 0QZ
- Mr J. Price
Bedford House
27-28 St George's Road
Brighton
Sussex
- Mr P. Beverley
Norwich Area Acorn User Group
Room 12a
Norwich City College
Ipswich Road
Norwich NR2 2LJ
- Keith Mitchell
Edinburgh ZX Computer Club
19 Meadowplace Road
Edinburgh
Tel: 031-334 8483
- Robin Bradbeer
Association of London Computer Clubs
Polytechnic of North London
Holloway
London N7 8DB
- ✓ **Andy Purkiss North & Mid-Essex User Group (NAMEBUG)**
12 Palm Close
Witham, Essex
Tel: 0376 515609
Prestel: 376515609
- ✓ **M. A. Cowley, President Beebnet**
PO Box 262
Kingswood
South Australia 5062
- Mr D. L. Evans
23 Hitchin Road
Henlow Camp
Bedfordshire
- ✓ **R. Welch Harpenden Microcomputer Group**
7 Tylers
Harpenden
Herts AL5 5RT
- Mr P. Frost
Atom Users Group
3 Leyland Road
Bulkington
Warks CV12 9LW
- Ray Mitcham
Southport BBC Micro Group
5 Easedale Avenue
Ainsdale
Southport
Tel: 79936
- ✓ **The Secretary Radio Amateur Micro User Group (G4KCS)**
c/o R. A. Webb
39 Aldworth Road
Stratford
London E15 4DN
- Malbeeb
BBC Users Club 'Micar'
St Monica Street
Guardamangia
Pieta
Malta
- ✓ **John Hannon Tasbeeb (BBC Users' Group)**
Box 25 PO
North Hobart
7002 Tasmania
Australia
Tel: (002) 342704
- A. F. Powell
The Daventry and District Computer Club
c/o The Daventry
Ex-Servicemens Club
Market Square
Daventry
Northants
- ✓ **BBC INFO**
Horten Inferiorhogskole
Skippergt. 6
3190 Horten
Norway
- ✓ **E. R. Piper Bognor Computer Group (BUG)**
2 Ely Gardens
Aldwick Park
Bognor Regis
Sussex PO21 3RY
- Andrew Pike
Peterborough Personal Computer Club
920 Bourges Boulevard
Peterborough PE1 2AN
Tel: 0733 44342 (after 5pm)
- Simon Sadler
Mid-Cheshire Computer Club
75 Swanlow Lane
Winsford
Cheshire CW7 1JD
- **Liverpool BBC Microgroup**
c/o Fred Shaw
14 Albany Avenue
Eccleston Park
Prescot
Merseyside L34 2QW
- John Harris
Bottisham Acorn User Group
1 Rowan Close
Bottisham
Cambridge CB5 9BN
Tel: (0223) 811487
- ✓ **Brian Pain BEEBACC**
40a High Street
Stony Stratford
Milton Keynes
Tel: (0908) 564271
- ✓ **Duncan Coulter Preston BBC User Group**
8 Briar Grove
Ingol
Preston PR2 3UR
- **Acorn Users Group of Sweden**
c/o Janne Soderberg
Frihetsvagen 32
S-175 33 Jarfalla
Sweden
- ✓ **Anders Wickman BBC User Group (BUG)**
Folkungagatan 58
116 22 Stockholm
Sweden
- Peter Wilson
Universal Micro Club
26 North Cape Walk
Corby
Northants NN18 9DQ
Tel: Great Oakley 742622
- ✓ **John Haigh Iver Computer Society (IC's)**
11 Colliston Walk
Fords Farm
Calcot, Reading
Berks RG3 5ZJ
Tel: 0734-417534
- John Eary
Kinder Peak Computer Club
36 Parkway
New Mills
Tel: New Mills 43870
- C. Verrier
Wandsworth Computer Club
Earlsfield Library
Magdalen Road
London SW18
- Mr J. Craig
National BBC User Group
40 Mount Pleasant Avenue
Wells
Somerset BA5 2JQ
- Mr R. Luff
Kingbee
54 Arlington Close
Kingswinford
West Midlands
- ✓ **Computer Club**
Caterham Leisure Centre
Godstone Road
Caterham
Surrey CR3 6RE
Tel: Caterham 48304/43316
- Ted Ryan
Eastwood Town Microcomputer Club
15 Queens Square
Eastwood
Nottingham NG16 3BJ
- ✓ **Mr T. A. Kayani SOBAT Computer Club (East London)**
12 Calderon Road
London E11 4EU
Tel: 01-556 5423
- Mr M. G. Forster
Potbug BBC Users Group
8 St George's Avenue
High Lane
Tunstall
Stoke-on-Trent
Tel: 818499
- ✓ **Steve MacLeod BBC Users Group of Canberra**
5 Hatfield Street
Evatt A. C. T. 2617
Australia
Tel: (062) 587719
- A. H. Fowler
Tonbridge School Computer Society
44 Birling Road
Tonbridge Wells
Kent TN2 5LY
- J. Assies, Secretary
Big Ben Club
PO Box 177
4670 AD Zevenbergen
The Netherlands
- H. W. H. Fisher
Sunningdale BBC User Group
82 Cedar Dive
Sunningdale
Berks SL5 0UB
Tel: Ascot 25030
- ✓ **Peter Hughes Format 40/80 Club**
BBC Disc User Group
5 Marsh Street
Bristol BS1 4AA
- Dave Davies
229 Manley Road
Chorlton-cum-Hardy
Manchester M21 1RB
Tel: 061-881 0382
- ✓ **Tony Latham Computer Users Club**
69 Hadlow Road
Welling, Kent DA16 1AX
- ✓ **Tony Pickard Newcastle & Washington BBC User Group (NEWBUG)**
c/o Washington Town Centre
Library
The Galleries
Washington, Tyne & Wear
Tel: Houghton (927) 849342
after 6pm
- ✓ **John Fryer, Treasurer ABUG**
17 Edgedale Road
Sheffield S7 2BQ
- ✓ **Chris Parry, Secretary Stratford Computer Club**
15 Kipling Road
Stratford-on-Avon
Tel: 0789 68080
- ✓ **Robert Watt Inverclyde BBC Micro Users' Club**
9 St John's Road
Gourock
Renfrewshire PA19 1PL
Tel: Gourock 39967
- ✓ **Antony Hurden West Suffolk BBC Micro Users' Club**
14 Plovers Way
Bury St Edmunds
Suffolk IP33 2NJ
- **Forum 80**
421 Endike Lane
Hull HU6 8AG
- ✓ **Simon Ward Porchester & Fareham Computer Club**
9a East Cams Close
Downend
Fareham
Hants PO16 8RP
- ✓ **D. Davidson Central Scotland BBC User Group**
1 Roxburgh Place
Larbert
Stirlingshire FK5 4UE
- ✓ **Linda Yeomans, Secretary Beeb Users Group (Bug Club)**
13 Regent Street
Church Gresley
Burton-on-Trent
Staffs DE11 9PL
- ✓ **Arjen Raateland Hopeatie 10A21**
00440 Helsinki 44
Finland
Tel: 90-5625027
- ✓ **Sqn Ldr J. A. Upham RAF Personal Computer Association**
Man S (ADP)
HQ RAFSC
RAF Brampton
Huntingdon PE18 8QL
- ✓ **Bazyle Butcher Harrow Computer Group**
16 St. Peter's Close
Bushey Heath
Watford WD2 3LG
Tel: 01-950 7068
- ✓ **MUSE (for teachers)**
PO Box 43
231/2 Friary Chambers
Whitefriargate
Hull HU1 2HD
Tel: 0482 20268
- ✓ **Nik Kelly Mersey BBC User Group**
56 Queen's Drive
Liverpool L4 6SH
- ✓ **R. V. Souter, Secretary TRS-80/Beeb Users Group**
4 Risby Garth
Skidby
Cottingham, Hull
HU16 5UE
Tel: 0482 845326
- ✓ **BBC Micro Club Tenerife**
PO Box 1297
Santa Cruz de Tenerife
Canary Islands (Spain)
Tel: (922) 216546
- ✓ **Rupert Steele Association of Computer Clubs**
17 Lawrie Park Crescent
London SE26 6HH
- ✓ **Andy Leeder Amateur Computer Club**
Church Farm
Stratton St. Michael
Norwich NR15 2QB
- ✓ **Bob Hindle South Yorks Personal Computer Group (SYPCG)**
139 Penrhyn Road
Sheffield S11 8UP
- ✓ **J. G. Dowling Acorn Atom Users Group**
27 Oribi Avenue
Van Riebeeck Park
Kempton Park 1620
South Africa

ATOM wanted. Floating point ROM, Toolkit ROMs, BBC Basic board, arcade games. Send details to: Joel Connault, Le Plan, F38490 La Batie Divisin, France. Tel: 76 3222 17.

GRAPHICS digitiser by Minor Miracles - mint condition - never used (unwanted Christmas present), new - £20, will sell for £14 or swap for Computer Concept's Graphics ROM. Contact Roger 09363 3872 after 5pm.

BBC model B, 1.2OS, DFS, fitted with Wordwise ROM, Sony cassette recorder, manual, cover, etc £420 ono. Phone Leeds (0532) 585853.

PRINTER £50. TTL level serial input plus power unit and software for Atom. Ex-Creed Teletype. Tubb, 35 Burns Road, Crawley, Sussex. Tel: Crawley 513354.

ATOM wants: 8271 controller pay £25; RAM card £10; BBC Users Guide £3.50; Lisp and Forth manuals £3 each; 6502 machine code (beginners) and magic book £2 each. Contact: Steve, 0752 776082.

TANDY TRS80 line printer III, BBC compatible, business quality dot matrix, 120cps takes up to 15in wide paper, mint condition - £225 ono. Tel: Welwyn Garden City 24591 after 6pm.

FOR SALE. BBC B, OS1.2, lead, manuals, boxed. Also many magazines, books, software and dust-cover. All for £395 ono. Phone Jason on 0803 28760, after 5pm.

PRISM Acoustic modem for BBC model B. Comes complete with all leads and ROM software in its original packing. £50 ono. Tel: Melton Mowbray (0664) 69013, after 6pm.

WANTED 8271 disc controller chip. Will pay up to £30. Phone Mark, Mold 58650 after 4pm.

OS1.2 ROM new and unused, in original packing with fitting instructions, complete. Double order error, hence surplus to requirements. £5.20, p&p all included. Phone Graham 0902 341189.

TEAC 100k disc drive with cables, manual, formatting and other discs. Used, perfect order. £95. Upminster (040 22) 29912.

ACORN 0.9 DFS ROM for BBC micro, only 3 months old. Sale due to system upgrade. £48. Phone Brian Emmerson 0392 860983 (Exeter).

BBC B 1.2OS, Acorn DFS, Wordwise, software worth £700, 400k double sided switchable disk drive, 34 floppies, green screen monitor. Worth £1,600, the lot for £1,055 ono. Tel: 047 283 378 after 7pm. Kevin Bramhill.

BBC B 32k OS1.2, little used, as new with cassette lead and approx £50 software. Bargain, £350. Billericay 56130.

ATOMCALC wanted, also Forth language for the Atom. Buy or exchange for similar - I have most other non-game software. Telephone Oliver 0626 862747, most times, most days.

CANON twin 40 track double sided drives with psu, double density capability 400/800k. Including BBC connector utilities, disc supplied, £300. Phone Bagshot 75672 (STD 0276).

ATARI 800 home computer plus Atari cassette recorder, three joysticks, music and Basic cartridges, mags and manual. £200 ono. Phone Matthew on Turton 852527 after 5.30pm.

WANTED Beebugsoft Sprite utilities (disc) or Simonsoft Sprites version 2 (disc or tape). Will make cash offer. Also Soft Machine Sprite Master considered. Tel: James, Cambridge 843606.

SILENT Computers' expandable console for BBC - worth over £62 - will sell for £39.99 ono. Also original Simonsoft Disassembler disk (40TK) - little used due to upgrade to 80TK drive - £6.50 ono. Tel: 061-224 0756.

ATOM floppy disk controller card including utilities disk £70. Tel: Bradford (0274) 612529.

8271 disc controller wanted. Will pay anything reasonable. Tel: Steve, Ipswich 680051.

ELECTRON, two months old, virtually unused. £40 worth of books and games - £175 the lot. Phone 0724 733780 after 6pm any day.

UNWANTED gift BBC B and BBC cassette recorder + 30 hour Basic and tapes etc. Cost £490 accept £300, no offers. All as new, boxed, not used. Telephone 0424 214521, Bexhill, E. Sussex.

NEW ZEALAND BBC user would like contact in UK. Would also like to swap software with them. Write: Andrew Phillips, 44 George Street, Geraldine, New Zealand.

BBC B & DFS, Epson FX80F/T, Microvitec mod res monitor, Sanyo cassette, Cumana 400k double drive 40/80, Wordwise, Disc-Doc, 70 games on disc, joystick. Everything, in fact. Cost £2,000+ accept £1,300. Under warranty. 01-850 7689, Eltham SE9. (Robert).

HELP! can anyone tell me how to connect my LA36 RS232 Decwriter 2 terminal to a fully expanded Acorn Atom? Please help! Michael Perris, 51 Barn Meadow Lane, Bookham, Surrey KT23 3EZ. Write only.

WANTED Atomcall ROM and manuals. Max price £10. Contact Mr Luck, EETEC, RAF Coningsby, Lincoln LN4 4SY.

WANTED 8271 disk controller chip. Will pay up to £40, for second hand chip. Bedford (0234) 856050.

FOR SALE. Microvitec 14" RGB monitor £150. Zenith green screen monitor £40. Both brand new boxed. Acorn speech ROMs including manual £25. Wordwise ROM including manual £25. Phone Peter, 01-958 8021 (Edgware, Middx).

FOR SALE. Complete set of Popular Computing Weekly. Total cost price over £36, will sell for £15 plus postage, or swap for ROM expansion board. Ring Andrew on Leek (0538) 383652 after 5.30pm.

BBC computer, disc interface and ROM board £350. Epson RX80FT printer £240. 100k Cumana drive £85. Sanyo high-res monitor £80. View £20. Disc-Doctor £15. BeeBase II £20. Graphics Extension £20. Ring Horley 75547.

WANTED 8271 disc controller. Tel: Ipswich 680051, (Steve).

SOLIDISK 16k sideways RAM board with over £1,000 worth of software including Starbase, Wordwise, Graphics ROM, Ultracall, Printmaster, Beebcall, Toolkit, Beebmon, Gremlin, Exmon etc. Whole package only £150 (duplicated gift). Phone (05827) 69152.

400K Mitsubishi DD/DS 40/80 track disc drive. Supplied with Disc Doctor ROM and 10 discs with Acornsoft business and games range, Gemini business, ROM dumps. Total value £1,500+, sell for £400. Tel: (05827) 69152.

OPUS 100k disc drive with leads, manual, and utilities disc. Six weeks old, £140. 48k Spectrum with £80 worth of software and manuals, 8 months old £90. Tel: (0865) 251684 or (0865) 249891 ext 6019, (Richard).

BBC B 1.2OS and cassette recorder, Wordwise ROM and lots of software including most Acornsoft games, £399. Phone 0705 592006 (near Portsmouth).

FOR SALE. Atari 2600 with two games, four joysticks and adaptor in good condition, £25. Telephone Carlisle 44882 after 6pm and ask for Michael.

WANTED Back numbers of AU, PCW, Byte. Also books for BBC micro. Tom Curran, Hampton, Middx. Tel: 01-979 3872.

WANTED BBC B. Will pay up to £250. Phone 01-474 2488 after 6pm.

SOLIDISK sideways RAM owner (no disks) needs tape copy of sideways RAM utilities (or source of listings). Can you help? Geoff Smith, 84 Edenfield Gardens, Worcester Park, Surrey KT4 7DY.

VETREX computer console includes built-in screen and joystick, three games, as new £50 ono. Phone Paul 021-422 4167 evenings.

EXCHANGE for BBC micro or sell for £353, The Open University: Micro-processors and Product Design - a course for engineers. Complete in original packing. Tel: Aylesbury (0296) 25504.

WANTED Software for Atom. Please send list of games for sale including prices to: Tim Welch, 'Orchard Cottage', Church End, Friskney, Boston, Lincs PE22 8SE.

WANTED 8271 FDC chips. Open to any reasonable offers for an 8271. Data sheets for 8271 and 8272 urgently required. If you can help, ring Stu on 061-485 2848, evenings please.

COMPUTER magazines. Practical Computing 58 issues from Vol. 1 No. 1 (Oct 78) to Vol. 6 No. 2 (July 83) £10. Your Computer from Vol. 1 No. 1 (June 81) to Vol. 3 No. 10 (Oct 83) £5. Phone John, Edinburgh (031) 331 2444.

ATPL's sideways ROM/RAM board, issue 4. Only a few months old, perfect condition. Comes with original fitting instructions, £35. Contact Sunindra. Tel: 01-555 9586 after 6pm.

BBC B unopened, Acorn DFS, light pen, official BBC recorder, many software titles disc/cassette, 4-pen colour printer programs, screen dump, books, worth £750 - offers? Telephone Ipswich (0473) 73203.

RH colour light pen for BBC B. As new, 6 months old, complete with manual and cassette, VGC, only £35. Tel: Jon (0305) 783810.

BBC model B with disc interface, LVL dual disc drive, 7 ROMs including View and Beebcalc. Also over 200 programs on disc, BBC data recorder and leads. Complete system £1,100 ono. Phone Canterbury (0227) 58529.

EPSON RX80F/T, hardly used - still in original packings with cable for BBC, manual, screen dumps, full box of paper - £259 ono. Also Quickshot joystick £5. Telephone Wombourne 897381.

BBC Spectra-vision Quickshot joystick with interface program - works even with keyboard only programs - still boxed, hardly used £14 + 75p p&p. Phone Richard Ross (0989) 62018.

SEIKOSHA GP100A Mk2 printer, Centronics interface. 10 months old, VGC: £175 ovno. Telephone Stickland, Market Harborough (0858) 64047 after 6pm.

WANTED for Atom. FP ROM, VIA, colour extension, tool kit ROM, Database, Wordpack, Database Forth, Diary utility pack, Word tutor. Send list and price to Cathal Mooney, 3 Mountross, New Ross, Co. Wexford.

MAGAZINES Full sets of Acorn User and The Micro User, plus six copies of A and B Computing for the BBC and Electron users. Good condition. Best offer takes. Phone Ian, Bridlington (0262) 601615.

BBC Quickshot joystick with interface program - works even with keyboard only programs - hardly used, still boxed £14 + 75p p&p. Tel: Ross (0989) 62018, ask for Richard.

GCC 13-ROM board. Only £30 inclusive. Also will pay well for any Intel 8271 FDC (working!). Phone 061-485 2848 evenings, ask for Stu.

ADE Systems text editor, malro assembler, and spy monitor, complete with manual and disc, only £40. (Doesn't work with 6502 second processor). Tel: John on Abingdon 20975, after 6pm.

WANTED BBC model B, cassette recorder, colour monitor, manuals, leads, games. Tel: Pontefract (0977) 796907.

UNWANTED gift. 'The Working Dragon 32' book. Practically new. Reason for selling - I have a Beeb! Phone 0525 381673 evenings and ask for Gareth. Asking price £3.50 including postage.

UNWANTED gift. 40 track 100k official BBC disc drive, unused. Complete £160 ono. Also two boxes Scotch discs (20) unused. £32. Frank Turley, 'Orchard Bank', Keswick Lane, Bardsey, Leeds LS17 9AG. Telephone 0937 73123.

BBC model B OS1.2, few books and stacks of original software. All leads and cables for £350 ono. Tel: 01-940 3562. Please ask for Jane.

PRINTER. Tandy TRS-80 four colour x-y plotter, 40/80 characters per line. BBC compatible, superb graphics with the two, graphic dump programs supplied in the price, £130. Iver (0753) 651417 (Slough area).

IKON floppy tape drive. Just plug in and go. Includes all leads, manual and operating chip, £85. Tel: Steve Wood, Staines 53386, weekdays after 5 pm.

WANTED. BBC B DFS drive(s) with manuals. Extras may be purchased with package. Also redundant or broken Video Genies, TRS80 models. Others to FHG, 19 Grayson Drive, Lowestoft, Suffolk NR33 7BA.

ROM extension socket. Mistake purchase so going for only £13 ono. Would cost up to £23 otherwise. Needs 21F socket (can supply). Phil Stubbington, 24 Thames Crescent, Maidenhead. Strictly no phone calls please.

BUSINESS COMPUTER. 16 bit, 8" disc drive, integral cassette, 17½" tractor printer, S100 bus, 2 consoles. Documentation available. £500 or why. Newport. Tel: Ickford 387 (Buckinghamshire).

ATARI 400 including cassette recorder and two Quickshot joysticks and lots of software £160 ono or swap for Acorn Electron. Tel: Woking 67454, after 4 pm.

FOR SALE. Shugart 40-track SS SD 100k, £100. Shugart 40-track DS DD 400k, brand new, £180 ono. Ring 051-648 4419. 21 Laurelhurst, Pensby, Wirral.

BBC B. 0.1OS. Could deliver within reasonable distance. Best offer secures. Tel: Upwey 2167 (Dorset).

WANTED. Atom Wordpack ROM. Tel: 0642 722141 extension 29. David.

MICRONET Modem 1000 plus ROM software for BBC B. New condition, still boxed, including full instructions. Bargain £50 ono. Tel: Kinston Blount 51694 (Chinnor, Oxfordshire), Mr Small, 8 Cherry Tree Road, Chinnor, Oxfordshire.

FOR SALE: BBC Basic board for Atom, £25 ono. Tel: Alan Brown 0932 47262 extension 30 daytime or 0483 578732 evenings.

BBC B 1.2OS, Wordwise, leads, condition very good, 16 months old but seldom used, £320 ono. Tons of software. Tel: 01-361 2954.

TORCH Z80 disc pack. Complete, boxed, virtually unused. Cost £840, sell £640. Also Newbrain model A, disc controller, CP/M disc, Newbas assembler, all available documentation, including software technical manual. Washington (0632) 4168041 evenings.

WANTED. Atom disc packs. Reasonable prices paid. Also non-working Atoms with new keyboard. Tel: Andy, Swindon (0793) 39736 week-day evenings and weekends.

WANTED. Atom software, particularly games pack 9 (Snapper). Tel: 01-459-3405 evenings and weekends.

ATOM BBC board MOS extension ROM. Fits BBC conversion board and gives BBC or Atom CDS at 1200 or 300 baud, £10. A. McIneeney, 32 Ardilaun Road, Newcastle, Galway, Ireland.

BBC model B with desk and software. Hardly used for lack of time, £350 ono. J. Faul, 9 Ellesmere Road, Twickenham TW1 2DJ. 01-892 8275 evenings.

BBC B, 1.2, Sanyo Cassette, manuals, books, cables for sale due to delivery of Apricot. Also BBC and Gemini programs. All at £350 (current cost over £500). Ring Hugh Somers at 01-221 7221.

BBC B, 5 months old, still under guarantee, perfect condition. I can't find the time to use it. Only £340. Tel: Clifton Hampden 7146. Some software also.

WANTED. Educational software for Acorn Electron - algebra - geometry - arithmetic - for age 14-15. Tel: David Thomas (0758) 612968 any time after 4 pm.

MICROWARE. Complete DDFS upgrade kit and manual. As new, unused, untouched, £80. Jim Botten, tel: 0895 448951 after 6.30 pm.

WANTED: Acornsoft View package. Please write stating price. Steve Price, 8 Staple Close, Waterlooville, Hampshire PO7 6AH or Tel: Waterlooville 58093 (home) or Cosham 321212 ext 5437 (work).

VIC 20 16k expansion, in excellent condition with tape recorder, joystick and games - Jelly Monster (cartridge), Pack of four games, and educational tapes. Sell for only £165. Ring 01-937 1992, any time.

BBC B wanted, also additional equipment, books, software considered. London area, will collect. Tel: 01-370 0718. Evenings: 01-373 6354.

AMBER 2400 dot matrix printer. Excellent condition. Leads for Acorn Atom, paper, ink cartridge. Data sheets, instruction booklet, £60. Tel: Kevin 04024 45464 (evenings only).

WANTED. BBC B computer. Must be VGC. No software required. Tel: 01-594 1965 (London area).

PRINTER. Star DP510 complete with interface cable, original packing, 2000 sheets of paper and telex rolls. As new, £200 ono. Tel: (0506) 42659 after 6 pm.

KENDA DMFS/DOS. Double density. No user RAM used, allowing easy transfer of cassettes. No limit to number of files. CP/M filenames. Recovery of erased files and lots more, £80. Tel: Rajiv, 01-204 1908.

SEIKOSHA GP-250X graphics printer with BBC cable, screen dump program, manual, new ribbon. Excellent condition £175. Tel: Wentworth 2621.

WANTED. BBC micro disc interface, will pay up to £60. Tel: Sheringham (0263) 823936. Ask for Jonathan after 6 pm.

WANTED. Any BBC ROMs - will pay £15 ono; your old 0.1/1.0 EPROMs - will pay £5 ono; ATPL ROM board - will pay £20 ono. Tel: 08833 7495.

SWEeper. Wanted data, plug-ins, spares for Telonic SM2000 Sweep Generator. Please ring Ralph Taylor, 0766 770637, evenings or write Bwlch Glas, Penrhyndeudraeth, Gwynedd LL48 6RU.

EXCHANGE back issues of American personal/hobby computing magazines. What have you? Smith, 84 Edenfield Gardens, Worcester Park, Surrey KT4 7DY.

JOYSTICK. Fantastic sure shot self centering joystick. Two fire buttons. As used in over 250,000 arcade machines worldwide. Sturdy construction. As new, boxed, still under guarantee, £13. Tel: (091) 336-2812 after 6 pm.

ACORN Atom 12k RAM, 8k ROM. Manuals, leads, some software. Factory serviced, good condition, £55 ono. Crook, Ongar (0277) 363615 (evenings).

ATOM 12k plus 12k, 3 books, games, plus Tandy 4-colour printer and cable, cassette recorder and lead, black and white TV. New £550, will sell £345. May sell separately. Write to D. Pearce, Powell House, Sedburgh, Cumbria (other offers are welcome).

GRAFPAD graphics tablet, brand new. Includes CAD specialist software, disc and cassette, manuals. Value £164 - will sell for £120. Morphy Encore chess computer. NICAD battery pack (rechargeable), £90 ono. Tel: 01-743 1579 (evenings).

TEAC 55A slimline disc drives. Pair, single sided 40-track 200k total, excellent units, genuine reason for sale, complete with format disc/manual. One only. £260. Offers, 0679 63611.

WANTED. Aids ROM, printer to suit BBC B. Solidisk sideways RAM board. Please telephone your price. Ask for Peter. Tel: Minehead (0643) 3969, after 6 pm.

BBC computer disc interface kit, full set of 11 chips, £95 ono. Martin, Bedford (0234) 46951.

BBC Model B, 1.2OS, Basic 2, switched mode PSU, £300. Also Hobbit with zero memory option, £70. Tel: 04026 7339 after 8 pm, Les.

BBC B with disc interface, Acorn 800k disc drives, Solidisk 32k RAM board, joysticks and vast collection of software, £900 ono. May split. Also Acorn Z80 second processor, £250. Tel: Richard, 01-340 0534.

WATFORD Electronics MK. 1 ROM socket board, with fitting instructions, for sale. First offer of £25 secures. Derek - Ruislip 31386.

TANDY colour graphics plotter, centronics (BBC compatible), serial interfaces. Complete kit, under guarantee, £95 ono. Also ZX81 - offers? Bryants, 1 The Hollies, Chalfont Lane, Bognor Regis PO21 5SX. Tel: 829478.

ATARI VC5 with paddles and joysticks, four cartridges, £60 ono. Please ring Doncaster 531175.

TELEPRINTER and BBC interface for sale, £40. Also disc interface kit wanted, will pay or swap for Teleprinter and interface. Tel: Cardiff (0222) 620053 after 5 pm.

BBC B, DFS plus 1.2OS plus Acorn speech, £385 ono. D. A. Shugart 5½ inch DD, £150 ono. Grundig 16" TV/Monitor, £200 ono or £700 for everything plus extras. Voltmace Delta 14b joystick, £10. Voltmace keypad adaptor box, £11. Advanced User Guide, £10. Tel: Plumtree 5143 evenings.

CUMANA CD200 dual 40-track disc drives, integral power supply with leads, formatting disc and manual. Still under warranty, £300. Leatherhead, Surrey (0372) 373740.

WANTED. Portable colour television, good working order. Price negotiable. Tel: Leyland 51720, evenings after 4 o'clock.

BBC B 1.2, Basic II, BBC DFS plus D/ drive, Wordwise and Tandy CGP115 P/printer plus desk plus programs. All-in price, £500. Contact Pat, 01-330 4662 after 6.30 pm.

ATOM routine wanted to disable break key - Basic or M/C. Write to Martin Coffey, 11 Courtfield Road, Ashford, Middlesex TW15 1JN.

WANTED. BBC Model B with disc interface and possibly disc drive. Tel: (0752) 51355 after 5 pm.

BBC Model B and disc interface (ANB03), Acorn fitted DFS. Issue 7. 1.2OS. 2.0 Basic. Four weeks old, £395. Tel: evenings, 0730 (Petersfield) 64059.

WATFORD ROM board, £22.50. 32k Solidisk sideways RAM and utility discs, £35. Forth ROM and manual, £22.50. Disc-Doctor ROM, £20. All manuals etc. Want colour monitor. Tel: 0635-41571 (Newbury).

JUKI printer, three wheels, and six ribbons, £300. Tel: Gloucester (0452) 421930 after 6.30 pm.

WATFORD ROM expansion board for sale, £24. Tel: Newcastle (091) 4886132.

WANTED. Acorn BBC DFS ROM. Must be 0.98 version. Telephone price to 0342 712448, after 7 pm.

EXCHANGE Moto-Guzzi V50II 6700 mls screen and other extras. For disc and printer system, approx value £800, compatible with BBC. Tel: 029-13 2298.

BBC Model B OS1.2, plus 5 games cassettes (worth £40), plus 2 books. All mint condition, £410. Tel: (Sidcup) 302-9952 (ask for Daryl).

BBC B 1.2OS Microware DDFS Teac (800k) 40/80 D/S disk drive, MCP40 printer/plotter, cassette recorder, disks, numerous games, utilities, EPROMs, books etc, joysticks. All as new, £750. W. Sussex (0903) 762093.

WANTED for Atom. Acorn Wordpack ROM, BBC Basic board, Forth and Lisp with manuals, games packs 9/11. No extortionate prices please. Phone Mark on Thanet (0843) 582132.

EPSON M-160 5x7 matrix printer. 24 characters single or double height or width printing and graphics. Barely used. Leads and screen dump included. Plug in and go! Only £45. Tel: 0780 740363.

BBC model B one year old with Exmon, Wordwise ROMs, BBC cassette recorder, computer table, software, books: £399, no offers. Ring John 0744 819453 (Merseyside) after 8pm.

KAGA Taxan Vision 1 RGB colour monitor, complete with lead for Beeb. As new and boxed. £175. Tel: John (0432) 271589, Hereford.

BBC model B 1.2OS, absolutely unused, £350 - no offers. Write to Mr D Leach, 104 St George's Square, Pimlico, London SW1.

WANTED Utility and application ROMs from Acorn, Computer Concepts, Watford, Beebugsoft, Pace, others? Eg View, Beebcalc, Graphics, Beebfont, Toolkit, Commstar, Toolstar, Database. Tel: 0792 207258 or write to 10 Benbow Close, Sketty, Swansea SA2 8LH.

FOR SALE. Shugart dual 100k disc drives with masses of software, only £380. Prism modem 1000, brand new, only £50. Tel: 0223 829384 after 6pm.

FORTY copies Personal Computer World. Offers/Swap. Wanted joystick for Beeb. Phone David 0756 3482.

CAN you help? Does anyone know where I can get a screen dump for a BBC B to a Dolphin BD80P? If you can help contact Mr Lutak on 021-358 6384 evenings.

BEEB PLOTTER. Watford, 4 months old, never used (£69 new) only £48 including tape, manual, postage. Write to Nasser, 8 Canterbury Hill, Tyler Hill, Canterbury, Kent CT2 9LS.

TELETEXT adaptor for sale, £150. Wanted: Daisywheel or other reasonably priced printer. Phone 02576 3271.

PRINTER. Seikosha GP80A graphic printer. Ready to use with Beeb, 30cps, excellent condition. Will give masses of paper with it. Asking £120. If interested phone 01-959 1916 and ask for Andrew.

PRINTER. Line Printer VII, excellent condition. Ideal for Beeb. Takes standard paper and labels. 8-bit dot image printing - screen dump included. Phone 01-693 8434, Micronet 01-639 7653. Mat Biggs.

PRISM modem 2000: for sale with ROM software and all leads etc. 4 months old, great condition, any offers considered. Phone Jason (0495) 271353 after 4.30pm on weekdays or any time on weekends.

WANTED. BBC model B, 1.2OS plus DFS. Also disk drive. 01-670 9147 after 7pm.

PRINTER. Centronics 739 dot matrix, including BBC cable. Graphics, proportional spacing, 80 and 132 columns, friction and tractor feed, 160cps. View printer driver £200 ono. Phone 01-654 2175 evenings only.

WANTED: BBC model B. Pay up to £250, more if extras included (ROMs, monitor, cassette recorder, etc). Phone Richard on 01-249 2406.

ATOM. FP ROM, Disatom, Word Pack ROM + 2 other toolboxes, VIA, printer driver. Timedata RAM card, (16-32k), plenty of software/books: it's packed full! 5V, 10A PSU. All in apple case - £125 ono. Phone Steve on 01-300 7128 (evenings).

BBC model B with Wdwise, disc interface, Cumana double disc drive, database on disc, manuals and box. £750 ono. Tel: Orpington 35784 or 01-303 9240 evenings.

ORIC 48k version, PSU, games cassettes plus software for morse tuition, QRA locator and RTTY split screen. £70. Also Mattel Intellivision console plus numerous firmware. Offers Denham (0895) 832147.

BBC model B, OS1.2, optional software and tape recorder, £350 ono. Contact: Lea Brindle, Bedford (0234) 218356 or 750111 ext 2235. Flat 1, 48 Shakespeare Road, Bedford.

SEIKOSHA GP100A graphics printer including cable for BBC, paper and graphics and text screen dump utilities for BBC. £160. Phone Chalfont St Giles (02407) 4827 evenings.

BBC model B, issue 7, 1.2OS, boxed as new with manual, welcome tape, guarantee card. Less than two months old £330 ono. Phone Erith 63841 after seven.

WANTED. P8271 - forty pounds cash waiting or Acorn or Watford OFS - pay up to £60. Phone Ken, Horley 71975 after 6pm.

WANTED. Acorn Atom computer. Tel: Worksop (0909) 721421 after 6pm.

BBC model B and Hitachi monitor for sale. 1.2OS. Good condition, £360 cash. London SW1, 01-834 0143.

BEEB PLOTTER graphics tablet for BBC B 32k, hardly used. Will draw and copy pictures in all modes. Instructions and software all included, £50. Tel: Stuart Sidders, Watford (0923) 31247.

BBC B 1.2OS, Acorn DFS, Wordwise, software worth £700, 400k double sided switchable disk drive, 34 floppies, green screen monitor. Worth £1,600 - the lot £1,055 ono. Telephone 047 283 378 after 7pm. Kevin Bramhill.

BBC model B, OS1.2, basic 2, Acorn disc interface. Official BBC disc drive 100k, some software. Offers between £250 to £350. Phone (0274) 501776.

WANTED. Compiler for BBC B. Must compile quickly and compactly. Willing to pay up to £10 for originals on tape (must include full documentation). Tel: Adrian 0705 372698.

EXPANDABLE CONSOLE FOR BBC MICRO

As supplied to Universities, Colleges, Schools, business & home users

A professional console to house disc drives/2nd processor/Torch dual drives/teletext, etc. All untidy wiring out of sight in the strong aluminium console in a matching textured colour. AVAILABLE NOW a bolt on extra module for extra expansions.

Also available a matching printer stand, yes stack your paper under the printer.

ALSO VDU STANDS AVAILABLE

Torch version available

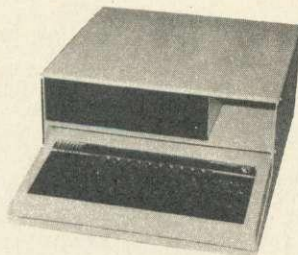

ELECTRON CONSOLES

The console houses the electron and will safely support the expansion interfaces which plug into the rear of the micro, supports the VDU and tidies up all wiring, allows expansion to disc at a later date.

PRICES
Special Torch Version £46.99 + £4 p/p
BBC Console £44.99 + £4 p/p
Bolt on expansion £14.99 + £2 p/p
VDU/Printer Stand £14.99 + £2 p/p
Electron Console £34.99 + £4 p/p

Please add VAT @ 15% to all prices

For further information enclose sae or send cheque to,

Mail Order Only **Silent** 01-801 3014 27 Wycombe Rd London N17

Viewing by arrangement

COMPUTERS

24 hour ansaphone

Please allow 28 days for delivery

MICROTEK COMPUTER SERVICES

Authorised

acorn  dealer

**B.B.C. B & acorn
electron**

CUMANA disk drives
DECCACOLOUR & MICROVITEC monitors
SEIKOSHA, EPSON & DAISYSTEP printers
ACORNSOFT/MERLE business software
ACORNSOFT full range

**NEXUS HOUSE
2 CRAY ROAD
SIDCUP, KENT
01 300 3075/6**

ACCESS/BARCLAYCARD WELCOME

ANNOUNCEMENT

* Northern Computers announce 6 new models of Micropulse 5.25" disc drive, manufactured and assembled in the North West, for the BBC computer. These drives are exactly compatible with the two Acorn/BBC disc formats. They are based on the highest quality Teac mechanisms with built-in power supply, as previously supplied by Cumana Ltd.

* Prices from **£119.95** + V.A.T.

* Also: High Quality 3" Compact Disc Drives

* Prices from **£129.95** + V.A.T.

* Each Micropulse disc drive is supplied with a BBC cable, formatter utility disc and comprehensive 55page disc filing system manual for the BBC computer.

* For further details send large S.A.E. to :



Northern Computers,
Churchfield Road,
FRODSHAM
Cheshire WA6 6RD
Tel: 0928 35110

For the BBC Computer and the Acorn Electron

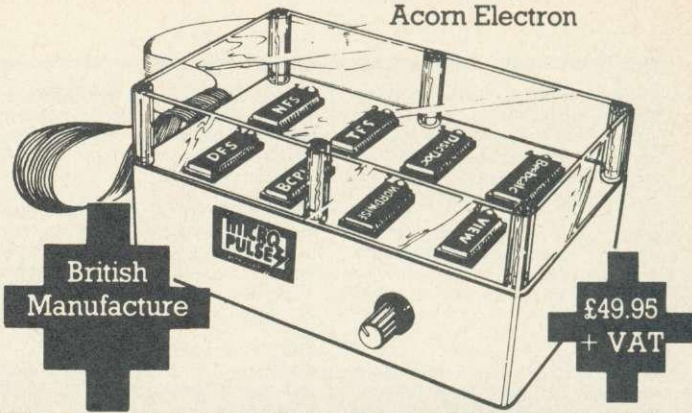

- ✦ BRITISH MANUFACTURE ✦
- ✦ ALLOWS 8 ROMS ON LINE
- ✦ HARDWARE-BASED ROM SELECTION AVOIDS SOFTWARE INTERACTION BETWEEN UTILITY ROMS
- ✦ SWITCH TO REQUIRED ROM USING MANUAL SWITCH OUTSIDE THE UNIT
- ✦ RED LIGHTS INDICATE THE SELECTED ROM
- ✦ HIT "BREAK" TO ACCESS ROM, NO NEED TO USE SOFTWARE COMMAND
- ✦ INCLUDES ZIF SOCKET, FOR INSTANT CHANGING OF A SELECTED ROM
- ✦ INCLUDES BBC CABLE AND ROM SOCKET CONNECTOR
- ✦ INCLUDES SIMPLE FITTING INSTRUCTIONS, JUST PLUG IN AND GO!

please contact: Gareth Littler
Mark Howard or
Judith Allen at
Micro Pulse
Division



Churchfield Road,
FRODSHAM
Cheshire WA6 6RD
Tel: 0928 35110

ACORN USER ADVERTISEMENT PAGES – SEPTEMBER ISSUE

3D Computers	144	Enigma	101	Musicsoft	85
AB Design	128	Ephagy Software	152	Newark Video Centre	85
Ack Data	160	Epic Software	150	Newnes Technical Books	86
Acorn	72/73	GCC (Cambridge)	131	Northern Computers	182
Acorn Vision	164/166/167	Gemini	30	Opus	32/152/159/175
AJ Vision	109	Golem	89	Pace	80/158
Akhter	26	GSL	98	Phimag	19
AMS	6	Guardian Software	162	Power Soft	160
Beebug	131	Harris McCutcheon	116	Printerland	83
Beebug	170	Holderness Computers	89	Quixtor	118
Beebugsoft	50/51	Inmac	90	Ranjan	162
Beebugsoft	4/5	Intec	14	SCI (UK)	105/107/109
Bel Tech	66	Interface	154	Screen	162
C-Tech	9	Intersoft	83	Silent Computers	181
Cambridge Computer Consultants	111	Kansas	162	Simonsoft	36
Care Electronics	58	Kansas	64	SIR	128
Chase Data	132/133	Kosmos	107	SIR	76
Cheetah Marketing	54	LVL	IFC	Skywave	144
CJE Micros	151	Learnwell	62	Slogger Software	84
Clares	24/25	Level 9	53	Softlife	152
CMS	16	Lifelong Learning	154	Solidisk	92/93
Computer Concepts	23/126/171	Loco Systems	120	Statacom	140
Computerama	1	Mayfair Micros	86	Superior Software	156
Computertown	172/173	Merlin	114	Superior Software	82
Consumer Electronics	11	Micheals Business Systems	62	Superior Software System	118/176
Control Universal	140	Micro Aid	34	Tandy	116
Cranfield	162	Micro Management	55/56/57	Technomatic	20/21/22
Cumana	71	Micro Solve	142	Third Program	142
CYB Design	150	Micro Writer	134/135	Twilstar	81/83/85/87/89/91
Database	28	Micro-Advent	86	United Disk Memories	148
Dataefficiency	68	Micro-Fast	146	Victor-Morris	160
Datapen	104	Micro-Fix	87	Viglen	119/121/122/123/125
Datastore	87	Micro-Man	16	Vine Micros	84
Datatechnology	12/13	Micro-Resources	142	Voltmace	76
Datastar Systems	100	Micro-Tek	181	Walton Associates	154
Diamondsoft	136	Micro-Vitec	174	Warm Boot	62
Discotechnology	60	Micro-Z	62	Watford	38/39/40/41/42/43/44
DPL	136	Micropower	46/138/OBC	West Coast Personal	160
Duckworth	120	Microtest	78	Zygon Products	101
ECCE	120	Microware	47	Sorting Program Courtesy of Gemini	
Elbug	112	Minns Sykes	17		
Electronequip	168/169	MLC	116		

DISC drive for BBC micro. Single, slimline, Microware drive, double-sided, 40-track (200k). Cased, with all leads for direct connection. Only £130. Telephone Max Heath, 01-363 7175, anytime.

TWO ATARI joysticks and Bud joystick interface to analogue port. (Immediately compatible with Acornsoft games.) £17. Also Spectravideo joystick for user port, and conversion tape £7. (01) 722 7846 evenings.

BBC B 1.20S Microvitec colour monitor, cassette recorder, joysticks; boxed and as new. Also 20+ games, manuals, 100+ magazines (including BBC/Acorn). Genuine bargain at £675. Caller collects. Telephone 0752 333479 evenings 6pm/7pm.

FINISHED with those back issues of Byte, DDJ, etc? Kilobaud/Microcomputing, 73, 68, 80 Micro, etc available to exchange. Send your list and wants to: Smith, 84 Edenfield Gardens, Worcester Park, Surrey KT4 7DY.

REGA Planar 3 turntable plus Goldring C920 IGC cartridge, £150 ono. Sir ROM board £35. Mono green monitor (BBC) £90 ono. Prestinox 35mm slide projector £30, screen £5. Intellivision cartridges £10 each. Complete computer system £900 ono. Telephone Mike on 051-933 8387, Liverpool.

TANDY CGP115 four colour printer/plotter plus £30 worth paper, pens, £115 ono. Phone Nottm 292055.

QUICKSHOT joystick plus joystick driver, good condition, £12. Telephone Nottingham 257355.

ROMs -HCCS Forth, Pace DFS, Beebase-1, £18 each. Prism acoustic modem for Prestel, £20. Quickshot joystick £10. Software included with modem and joystick. Tel (0782) 314053 after 7pm.

BBC ROMs for sale. Wordwise and Advanced Graphics ROMs. Worth over £40 each, will accept £20 each. Reason for sale: unwanted gifts. Ring 01-552 3181 after 4.30pm. Ask for Sukhjit.

TANDY CGP115 4 colour printer/plotter. Excellent condition, in box with BBC centronics lead, £100 ono. Telephone Walsall (0922) 24850.

SPEECH synthesizer for BBC computer. Cheetah Sweet Talker. Only one month old, £15. Tel: 0620 285003.

BACK issues of Kilobaud/Microcomputing, 68, 73, Micro 6502, 80 Micro, etc. SAE list. Exchanges welcomed (American magazines only). Smith, 84 Edenfield Gardens, Worcester Park, Surrey KT4 7DY.

WANTED Quickshot II Joystick. Ring (0840) 212550 from 5-6pm, ask for Simon.

BBC B 1.20S, Acorn DFS, manual, leads, some software magazines, BBC data recorder available. £400, very good condition. Phone Appleby (Cumbria) 52358.

PRINTER Tandy CGP-115, 40-80 characters/line, in 4 colours. Also does graphics. Boxed with manual as new, £100. Tel: 0325 312417.

NEW! Edit 7-mode 7, full feature, 10 page text and graphics editor £5. Disassembler-£3.50. Egg-the upgrade-8 new boards, joysticks and more for Chuckkie Egg, £3.50. Cheques, POs to Crystalsoft, 8 Pepys Walk, Langney, Eastbourne, Sussex BN23 7QR.

ROMboards? Fit a ROM Extension Socket to your Beeb's keyboard instead. Use any number of ROMs. Rapid change over. Easily fitted. £19.99 inclusive. Steelappeal, Hambledon Close, Blandford, Dorset. Tel: (0258) 53742.

Beams designed to BS.449 (steel) and CP.112 (timber) for architects, engineers, builders. Printout satisfies L.A. Send large SAE to Beamscan, 20 Vaughan Avenue, Hendon, London NW4 4HU.

Interface board for BBC micro, provides 8 channel ADC, real time clock, allophone speech synthesiser, 4 I/O ports and DAC. All for £70. Send SAE + 50p for full details to VM Interface, 42 Arnham Road, Preston PR1 4QN.

BBC Image ultimate tape back-up copier. Copes with locks, files, any length, false addresses, ?'s in filename, 300 + 1200 baud. Unlocks/locks programs. 100% M/C. £3.80. P Donn, 33 Little Gaynes Lane, Upminster, Essex RM14 2JR.

Super BBC fun learning package, Resource & Builder, used in schools. Test your knowledge before you ask the children. £10 inc postage. Endless possibilities. Creative Learning Programs Ltd, 9 Silver Park Close, Aldershot GU13 0BP. Telephone: 02514 6215.

Nutcrackers. Tape 2 tape + tape 2 disc + disc 2 disc + disc 2 tape: £5. 'C40 to 80': 40 track to 80 track converter: £5. 'Rompull' + tape dump + 'tape recover': £5. R-Soft, 22 Marriott's Close, Felmersham, Beds MK43 7HD. Tel: 0234 781730.

BBC Micros. Large stock of model Bs, clearance sale £370 each all inclusive. Phone Hot-

line (0632) 737654. Kumar Computers, 9 Crossley Terrace, Newcastle NE4 5NY. Limited offer.

Antistatic washable dusters containing 1% stainless steel. Removes risk of disk drop outs, EPROM damage and high voltage screen static. 50p each or £4 for 10. Peter Drew (Textiles) Ltd, Canada House, Bidford-on-Avon, Warks B50 4JN.

Advanced User Guide binders. Stiff plastic backed, titled, open flat, ring binders. £3.50 inc p&p. Hepworth & Co, Waulkmill Farm, Ingersley Vale, Bollington, Cheshire SK10 5BP.

INDEX - The different database. Store any article reference or a synopsis on your favourite subject. Any length of record. Filing/search using own keywords. Details: Vicdata Software, 30 Repton Way, Rickmansworth, Herts WD3 3PW. £8.25.

'Superior Mover' Last chance! Moves Hunchback, 2002, Qbert, Roadrunner, etc automatically to disc: ready to run. £5. R-Soft, 22 Marriotts Close, Felmersham, Beds MK43 7HD. Tel: 0234 781730.

BBC unwanted software: Gemini's Cashbook £30. Software for All's Purchase/Sales Ledger £20 (each). All originals, (disk). M. Mynott, 116 Churchill Road, East Barnet, Herts.

Copyking back-up tape copier. Multiple copies from single loading. 300 + 1200 baud, Locks/unlocks. £3.50. Electron/BBC B OS1.2-state which. T Thornham, 6 The Meadows, Walberton, W. Sussex BN18 0PB.

500 Labels £3.50, VAT/delivery included. Two across, 3 1/2". Barrington Associates Ltd, FREEPOST, Cheadle Hulme, Cheshire SK8 7YB.

I say, I say, I say... anything. Interrupt driven speech synthesiser - best yet! Resident vocabulary. BBC only. Software ROM. £34.99 + 50p p&p. Cheques and POs to Metron Audio,

7 Delilah Road, Hamworthy, Poole, Dorset.

Juki 6100 daisywheel printers. New/guaranteed. £375 including VAT. Free delivery in the UK. Also 400k/800k disc drives from £189 delivered. Woking (04862) 62020, anytime.

'How to' move your s/w from tape to disk. Cassette with 9(!) utilities and extensive documentation: £5. R-Soft, 22 Marriotts Close, Felmersham, Beds MK43 7HD. Tel: 0234 781730.

Printwise adds power to Wordwise/Epson. Simple commands replace messy control codes. Also Greek (FX only), macros, autonumbering! £12.50 (disc) or SAE details. Astrosoft, 39 Latimer Way, North Pickenham PE37 9JY.

Ardsoft Educational Software announce the release of their new, quality educational software. Free catalogue and demo cassette available on request. Send 50p (p&p) to Ardsoft Educational Software, 20 Castle View, Leeds LS17 5BY.

Joysticks - top quality at amazing low price. Only £9.95 a pair. Easier to handle and faster than others costing twice as much. Cheque/PO to Peritron, 21 Woodhouse Road, London N12 9EN.

Stolen during burglary - BBC model B, unmodified, serial No. 10 - ANB01-3050166; Philips D2924 keyboard entry LW/MW/SW/VHF; Radio, LCD display, Serial No. 10288; Network NW900 cassette recorder. Reward offered: Phone 01-954 2311 ext 4325.

Heartrate monitor - BBC B. Complete hardware (built) + software cassette, displays heartbeat trace on screen + digital pulse readout, optional 'ECG' beep etc. Plugs into analogue port, detects pulse from finger held on infra-red sensor. Details included for use as a lie detector, monitoring fitness etc. Introductory price only £15.95 inc. Computer People, 30 Westholme Gardens, Ruislip, Middx.

£10 SMALL AD SERVICE

Please include your cheque for £10 made payable to Redwood Publishing. This is the standard fee. Don't forget your name, address or phone number. Send cheque plus form to Acorn User Small Ads, 68 Long Acre, London WC2E 9JH.

The old joke is on Torch

■SO, having been bought up by Acorn, Torch has now done its own thing and bought up the distribution rights to the Graduate from Data Technologies (founded by Martin Vlieland-Boddy, who set up Torch – small world isn't it?).

Well, having got the topical intro out of the way, let's get down to the joke. Here goes . . .

Imagine it's Christmas and Hermann Hauser's three lads come up to sit on dad's knee and ask for their presents.

Oldest boy: 'I want a Porsche like yours, dad.'

HH: 'Fine son, it's on the way.'

Second boy: 'Dad, can I have a Macintosh?'

HH: 'Sure son.'

Youngest boy: 'Please daddy, can I have a cowboy outfit?'

HH: 'I'll go out and get you one right now.' So Hermann pops out and buys him Torch!

■WITH the Acorn share price leaping to 193p and then diving to 120p Acorn Abuser asks: Which Acorn directors have recently taken holidays in the Bahamas?

■ACORNSOFT has added the exciting Progo to its range of languages. Progo is a cross between Prolog and Logo designed for artificially intelligent turtles.

Languages supremo Paul Finland commented: 'Progo will be available on the Electron as soon as we get the plus 5 Mouse interface.'



ACORN is very proud of its record in introducing women to computing, and nowhere was this in greater evidence than at the WI Leisure Exhibition. Even the Queen came along to take a look at the stand. However, a certain hypocritical view has been noticed in the company's sponsorship of one of the most sexist of sports, motor racing. This even stretched to providing two 'dolly birds' to kiss the winners at the British heat of the F3 European championship.

Mind you, at least Acorn did turn out for the Women's Institute because, as Acorn's PR men assure us in their release, no other computer company did. Furthermore, nearly all the staff on Acorn's stand were women, taken from the education and customer services divisions.



ACORN ABUSER'S

Diary

'The micro-mouse and micro-turtle communicate via own language, Smalltalk,

which should be available in the third quarter.'

■A VISITOR to Acorn's London HQ in Henrietta St. recently complained his Acornsoft disc would not work. On being asked for the disc, the customer removed his wallet and extracted a floppy disc, which was carefully folded into four!

When told it couldn't be replaced he replied: 'But I was told a floppy disc was flexible.'

■B&G Software has developed the ultimate in protection devices for the company's new cassettes. It's so secure that not even their tape duplicators can break it.

■A&B quote '... launch of Data Technologies' IBM PC compatible upgrade for the model B. The Cambridge hot-

house continues to produce revolutionary products to support the BBC and this one is particularly well branded as the 'Graduate'.

Not a bad writeup considering the UdderGraduate is DT's first product.

■ALL these rumours about a new Acorn DFS! Our very own disc controller Orson Fact interviewed Hуго Thighsson, the man who gave us 0.90 and then emigrated.

HT: 'In the beginning there was 0.90. Then I created the 57 internal varieties resulting in 1.2 for the second processors.'

'There is no such thing called the ADFS – it doesn't exist – and it certainly won't be released this year. No it isn't compatible with the Watford DFS.'

Hуго has recently been replaced by Australian Bruce Cowboil, who shot to prominence in Rooland for causing the great Fosters drought of 1982.

■ACORN International MD Bob Mayhem has reacted angrily to allegations of selling lethal Exocet local area networks to Argentina. Roving Acorn reporter Orson Fact was passing through Brazilia when he saw a shipment of Level II Flyswatters on its way to Buenos Aries (codenamed Aries B20 in the Falklands war).

When quizzed as to the fighting potential of the Flyswatters Mayhem retorted: 'They are completely harmless without the DNFS 3.0 arming device. Vector sent those to Iraq.'

```

10 MODE2:VDU23:B202:0:0:0:
20 *FX9,4
30 *FX10,4
40 VDU23,224,255,255,255,255,255,255,255,255
50 COLDUR130:CLS
60 VDU23,225,0,127,64,127,96,63,32,63
70 VDU23,226,0,254,2,254,2,252,4,252
80 VDU23,227,128,255,128,128,255,128,128,255
90 PROCCL(500,500)
100 VDU4:CDLDR0
110 PRINTTAB(3,2):"Ever wanted to""TAB(3):"blow up a QL ?"
120 PRINTTAB(5,28):"HIT SPACE..."
130 REPEATUNTILBET=32
140 GC0L0,1:MOVE50,200:DRAW600,480:MOVE1200,200:DRAW600,480
150 FORT=1T0200:NEXT
160 CLS:SOUND0,-15,7,50
170 FORX%=1T080
180 R=RND(2)
190 IF R=1 GC0L0,12 ELSE GC0L0,14
200 MOVE550,500:DRAWRND(1280),RND(1000)
210 GC0L0,0:PLOT69,RND(1280),RND(1000)
220 NEXT
230 PRINTTAB(2,5):"TOUGH LUCK CLIVE!"
240 FORT=1T04000:NEXT
250 RUN
260 DEFPROCCL(X%,Y%)
270 VDU5:GC0L0,8:MOVEX%,Y%:PRINTSTRING#(3,CHR#224)
280 GC0L0,15:MOVEX%,Y%:VDU225,226,227
290 VDU4:ENDPROC
    
```

Bit of a silly one this. The idea of the game is to blat the QL – and all you have to do is press the space bar. As the authors, Richard Batt and George Martin, admit, the program is of little educational value, but they did put it together at the end of a computer studies lesson. Other readers have only to send in their entries and, who knows, they too might win one of our coveted software prizes.

NEW RELEASES

**BBC
MICRO**

SPECIAL OFFER!
Order both
directly from
us and deduct
£1 from each.

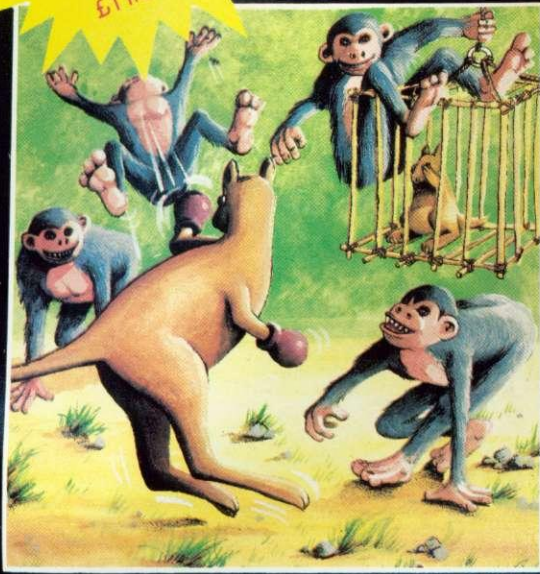

WALLABY (32K)

£7.95

From the author of Overdrive comes another superb arcade-action game. You must guide Wally the Boxing Wallaby up the ladders to rescue the baby wallaby from its cage. The evil monkeys will try to stop Wally in his tracks; he can kill the monkeys by a swift upper-cut, but watch out for the apple-cores which they hurl at him without compassion. Five screens of increasing difficulty with bonus fruit on each level. Yet another winner from Superior Software!

●●●NEW RELEASE●●●



Many of our titles are available in Boots, W.H. Smiths, John Menzies, Rumbelows, Laskys, Currys, HMV, Greens at Debenhams and Spectrum Shops. Also at all major computer dealers - Eltec Computers, Micro Management, West Coast Personal Computers, Microstyle, Electronequip, 3D Computers, Computerama, GTM Computers, etc. Our software is also available through all the major distributors, and directly from us by mail-order.



SMASH AND GRAB (32K)

£7.95

An excellent and original arcade-style game in which you take the role of a robber aiming to snatch bags of gold from the bank. A policeman is after you... he is able to jump at you or squat down and try to hit you with his truncheon. You must also keep clear of the flying police cones and floating dustbin lids. There are 3 fascinating screens of action including play streets with bouncing balls, one-way streets, conveyor belts, traffic lights and police-boxes. A novel and amusing game.

(KEYBOARD OR JOYSTICKS)

●●●NEW RELEASE●●●

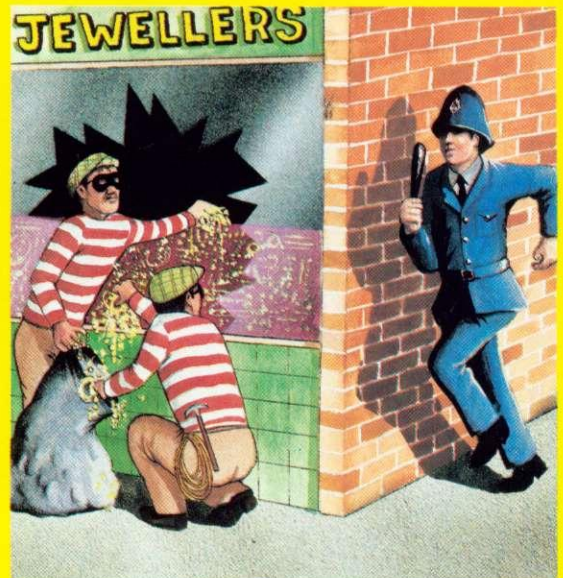

WE PAY UP TO 20% ROYALTIES FOR HIGH QUALITY BBC MICRO AND ELECTRON PROGRAMS.



SUPERIOR SOFTWARE LTD.

Dept. AU9, Regent House,
Skinner Lane, Leeds 7
Tel: 0532 459453

OUR GUARANTEE

- (1) All our software is available before we advertise.
- (2) All our software is despatched within 48 hours by first-class post.
- (3) In the unlikely event that any of our software fails to load, return your cassette to us and we will immediately send a replacement.

M I C R O P O W E R M I C R O P O W E R M

AN EXCITING NEW BBC MICRO PROGRAM FROM BRITAIN'S LEADING SOFTWARE HOUSE

RipDune Ridler

Cross the desert wastes of the barren world. Shoot down the Moebian fighters flying overhead and catch the fuel cannisters dropping from enemy tankers. Jump over molten lava pools and blast the radioactive rocks which block your way. Super smooth scrolling landscape and seven types of alien craft.

Only £7.95



AVAILABLE FROM ALL GOOD RETAILERS INCLUDING SELECTED BRANCHES OF:

WRITTEN ANY PROGRAMS?
WE PAY 20% ROYALTIES!



The following top titles are available for both the BBC Micro and Electron: Killer Gorilla £7.95/ Bandits at 3 o'Clock £6.95/Moonraider £7.95/Croaker £7.95/ Felix in the Factory £7.95/Felix and the Fruit Monsters £7.95/ Chess £7.95/Draw £9.95/Escapes from Moonbase Alpha £8.95/ Cybertron Mission £7.95/Swoop £7.95/Intergalactic Trader £8.95/ Positron £6.95/Adventure £7.95/Galactic Commander £7.95/ Danger UXB £7.95/Electron Invaders £7.95/Ghouls £7.95

SHOWROOM: NORTHWOOD HOUSE, NORTH STREET, LEEDS LS7 2AA Tel: (0532) 458800

MAIL ORDER: MICRO POWER LTD.

SHEEPS CAR STREET SOUTH, LEEDS LS7 1AD

Tel: (0532) 434006 P & P: 55p per order

SPECIAL OFFER: Deduct £1 per cassette when ordering two or more

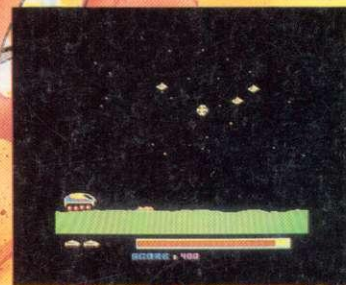

M I C R O P O W E R M I C R O P O W E R M